

# VF X Series

## SKOPE Vertical Freezer

---



VF650X



# SKOPE Warranty Protection

Register now for peace of mind

It's quick and simple. Take a few minutes to register your SKOPE product and enjoy more efficient support plus other warranty benefits. When registering, make sure you have your cabinet serial number at hand.

**To register online:**

Visit our website at [www.skope.com/warrantyprotection](http://www.skope.com/warrantyprotection) then complete and submit the online registration form.



**Or freephone:**

1800 121 535 (Australia)

0800 947 5673 (New Zealand)

**SKOPE 1-year Extended Warranty**

Extend your Warranty Protection by 1 year during registration. Please check you have not already organised an extended warranty through your dealer at time of purchase. For pricing information on an extended warranty visit [www.skope.com/warrantyprotection](http://www.skope.com/warrantyprotection)

## Service & Support

We know you will get years of satisfaction from your new SKOPE product when you follow a few simple preventative maintenance guidelines.

Helpful information is available on our website [www.skope.com/serviceandsupport](http://www.skope.com/serviceandsupport)



Thank you for purchasing a SKOPE refrigeration product.

# CONTENTS

---

## 1 Installation

Safety First	4
Positioning the Cabinet	5
Climate Class	5
Freezer Location	5
Power Cord	5
Ventilation	5
Door Handles	6
Fitting Door Handles	6
Removing Door Handles	7
Shelves	8
Shelf Clips	8
Repositioning Shelves	8

## 2 Operation

Automatic Start-Up	9
Loading Product	9
Electronic Controller	10
Introduction	10
Faceplate	10
Defrost	11
Continuous Cycle	11
Temperature Setpoint	11
Controller Reset	12
Alarms	13

## 3 Servicing

Cleaning	14
Cabinet	14
Condenser Coil & Filter	14
Lighting	15
Troubleshooting	16

# 1 Installation

---

**Safety First** Always observe safety precautions when using any electrical appliance. Read these instructions carefully and retain them for future reference.

- When the appliance is used by or near young children or infirm persons, close supervision is necessary, especially to ensure children do not play with it.
- Do **not** use this appliance for other than its intended use.
- Do **not** cover the grilles or block the entry or exhaust of airflow by placing objects up against the refrigeration unit.
- Do **not** probe any opening.
- Do **not** store explosive substances such as aerosol cans with a flammable propellant in this appliance.
- Only use this appliance with the voltage specified on the cabinet rating label affixed to the inside of the cabinet.
- Ensure the appliance has adequate ventilation as this is essential to economical, high performance.
- Be careful not to touch moving parts and hot surfaces.
- For your own safety and that of others, ensure that all electrical work is done by authorised personnel.
- If the power supply flexible cord becomes damaged, it must be replaced by an authorised service agent or similarly qualified person in order to avoid a hazard.
- Ensure all necessary safety precautions are observed during installation or removal of the refrigeration unit.
- This appliance is not designed to be stable while in motion. Use extreme caution when moving or transporting the appliance.
- Please contact SKOPE customer services for advice regarding disposal of this appliance.

**WARNING**

**Always** isolate the freezer from the mains power supply before attempting any maintenance.

Twin unit freezers have two separate power supplies.

**WARNING**

Ensure the door/s are held shut when moving or transporting the freezer.

**CAUTION**

**Never** overload the power supply, which could damage the freezer and product. See the rating label inside the cabinet for the safe power supply and current draw.

## Positioning the Cabinet

**Climate Class** The freezer is designed to operate within a climate class 5 environment (40°C @ 40% RH). We recommend that you put the freezer in the coolest place possible because it will use less power and last longer.

**Freezer Location** Avoid direct sunlight, warm draughts etc. Allow adequate space for doors to open and close properly. Self-closing doors have internal torsion bars pretensioned at the factory, and must be unobstructed. Ensure the cabinet sits on a level surface so that the doors shut and correctly seal. Level footing also prevents the condensate tray from overflowing. After final positioning, the front castors may be locked to prevent the cabinet moving.

**Power Cord** The power cord exits from the top rear of the cabinet and is fitted with a 3-pin plug. Pull the power cord around so that it's not trapped before you position the cabinet. **Note:** Single unit freezers are fitted with one power cord. Twin unit freezers are fitted with two power cords one for each refrigeration unit.

**Ventilation** See diagram below for ventilation requirements. When positioning the freezer, ensure there is at least a 200mm space above the top panel. Adequate ventilation around the refrigeration unit is essential for efficient operation. The air surrounding the refrigeration unit must not exceed 40°C. Keep the ventilation slots at the top of the cabinet clear at all times and **never** store cardboard cartons or other objects on top of the freezer.

**Note:** Remote cabinets require a minimum of 300mm clearance above the top panel to allow for service access.

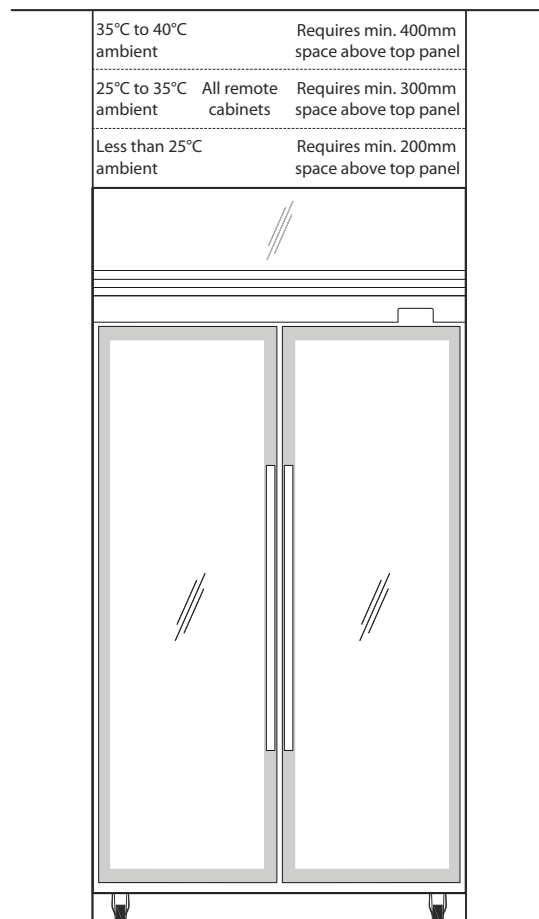

## Door Handles

**Fitting Door Handles** For transit purposes the door handles may be packed separately inside the cabinet. If the door handles are packed separately, follow the steps below to fit them to the door/s.

### To fit a door handle

1. Remove the handle/s from inside the cabinet by carefully cutting the cable ties securing the handle, and remove the packaging.

2. A metal spring clip is fitted inside the handle mounts at each end of the handle. Ensure that the spring clips point up.

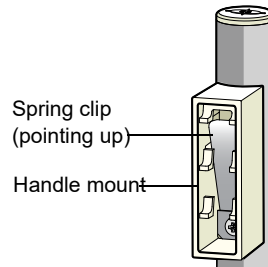

3. Locate **BOTH** handle mounts simultaneously onto both door brackets. Then push the handle down onto the brackets, until the handle locks into place.

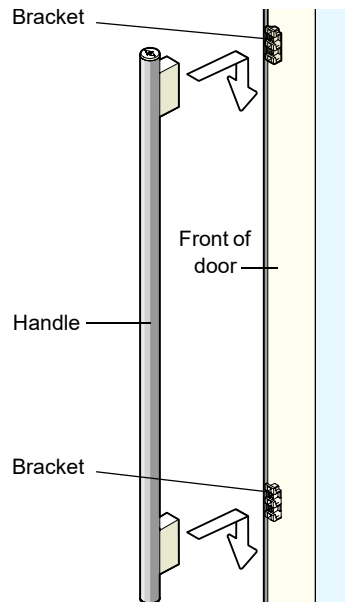

#### CAUTION

Ensure **BOTH** handle mounts are located before pushing down.

4. If the handle does not lock into place, check that the spring clips are pointing up and try again. If only one end of the handle locks into place, unscrew the door handle (see over page), and refit ensuring both of the handle mounts are located onto the brackets before pushing the handle down and locking into place.

**Removing Door Handles** The door handles can be removed for transporting and moving the cabinet through doorways, or for refitting.

### To remove a door handle

1. Open the door, and peel back the door gasket from behind the handle mounts on the inside of the door frame.
2. Unscrew the handle mounts through the holes on the inside of the door frame, and remove the handle.

3. Remove the bracket/s from the handle mount by pressing the bracket in and down until it unclips from the handle mount.

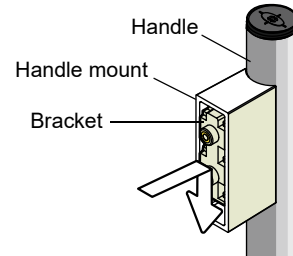

4. Fit and screw the bracket/s back onto the door. Ensure the catches are pointing up as pictured.

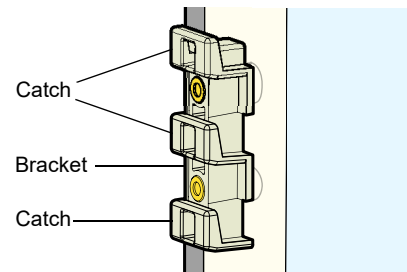

5. Refit the door gasket by clipping it back into place on the inside of the door frame. If the gasket is out of shape after refitting it, a hair drier can be used to heat and reshape it.

## Shelves

---

The freezer is fitted with five layers of wire shelves which may be positioned at different heights to suit various products.

**Shelf Clips** Each wire shelf is held in place with four shelf clips, which engage in the shelf support strips and slide up and down to the desired shelf position.

The support strips are numbered for easy location of shelf clips. View the numbers in the bottom LH corner of the shelf clip.

### To fit a shelf clip

---

1. The shelf clip twists onto the shelf support strip. Position the shelf clip with the flat side up against the shelf support strip and the two prongs pointing up. Twist the top of the clip anticlockwise onto the shelf support strip until it locks in place.

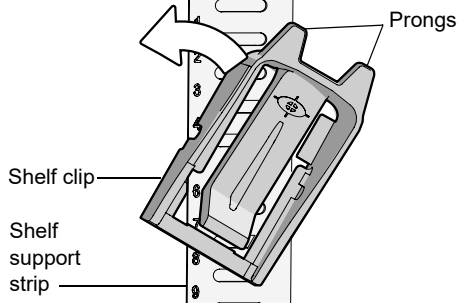

### To slide a shelf clip up and down

---

1. Pull the shelf clip tab up and slide the shelf clip up or down as required. Once in position, ensure the shelf clip is locked into place.

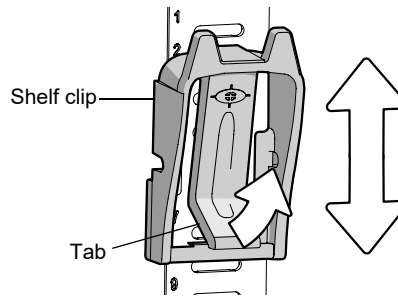

### To remove a shelf clip

---

1. Pull the shelf clip tab up and twist the top of the clip clockwise off the shelf support strip.

**Repositioning Shelves** When repositioning shelves, unload and remove the shelf, establish the desired position and slide the shelf clip in each of the shelf support strips to the desired position (see above). Sit the shelves on the shelf clips.



## 2 Operation

### Automatic Start-Up

After the cabinet has been positioned in a suitable place, plug it in and check the following activity.

Item	Activity
Condenser Fan	The condenser fan starts and runs at a slow speed. When the compressor starts, the condenser fan will run at full speed.
Lighting	The lights that illuminate cabinet interior and top sign (where applicable) will come on when the freezer is turned on. The light/s can be switched on and off via the electronic controller (see over page).
Electronic Controller	An electronic controller runs the freezer and is visible on the control panel above the door/s. The electronic controller display panel shows the cabinet temperature.  <b>Note:</b> Twin unit freezers are fitted with two electronic controllers, one for each refrigeration unit. Only one electronic controller is visible.
Compressor	The compressor starts about one minute after the lights go on. The compressor turns off when the product temperature reaches around $-21^{\circ}\text{C}$ and turns on again when it reaches about $-18^{\circ}\text{C}$ .
Evaporator Fan	The evaporator fan will not operate until the evaporator probe senses a temperature of $-8^{\circ}\text{C}$ in the evaporator coil. When the evaporator coil is below $-8^{\circ}\text{C}$ , the evaporator will run at low speed or high speed as required.

### Loading Product

Let the freezer run for 30 minutes before loading it with product the first time. When loading the freezer:

- ▣ Allow adequate air space around each item to ensure even cooling and efficient operation of the freezer.
- ▣ Do not exceed a maximum load of 20kg per shelf.
- ▣ Remove some product if the shelves are flexing.
- ▣ Do not let anything overhang the shelves because this might stop the doors from shutting or even break something.
- ▣ Do not load product on the cabinet floor.
- ▣ Do not load product above the load limit indicators shown on the cabinet interior sides (see image below).



For security, there is a lock bracket above the door where you can attach a padlock and secure the door.

## Electronic Controller

**Introduction** The electronic controller controls the freezer, displays the freezer temperature and signals temperature alarms. It uses temperature probes to collect data and runs the freezer accordingly. The electronic controller is pre-programmed and usually requires no initial setup or additional programming. SKOPE does not recommend that the settings be changed unless necessary.

**Note:** Twin unit freezers are fitted with two electronic controllers, one for each refrigeration unit.

**Faceplate** Because the electronic controller plays such an important role, it's helpful to know the parts of the faceplate you may use.

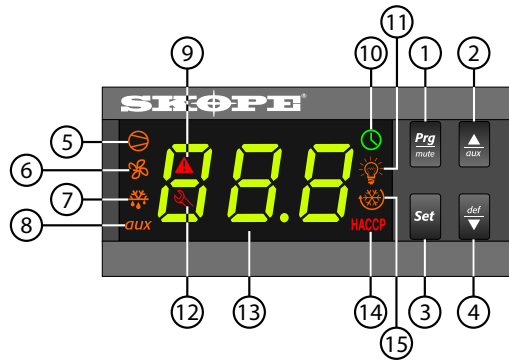

No.	Item	Description
1		<b>Prg / mute:</b> To initiate program sets, press for 5 seconds. Mutes the audible alarm (buzzer).
2		<b>UP / aux:</b> To switch light/s on and off. To scroll settings <b>UP</b> (in program mode).
3		<b>Set:</b> If pressed for more than 2 seconds displays and / or enables changing the temperature setpoint (see page 11).
4		<b>DOWN / def:</b> To scroll settings <b>DOWN</b> (in program mode).
5		<b>COMPRESSOR:</b> ON when the compressor and condenser fan starts. Flashes when activation of the compressor is temporarily delayed.
6		<b>FAN:</b> Shows when fan is operational.
7		<b>DEFROST:</b> ON when the defrost is activated. Flashes when the activation of the defrost is temporarily delayed due to procedures in progress.
8	<b>aux</b>	<b>AUX:</b> n.a.
9		<b>ALARM:</b> Flashes in the event of alarms.
10		<b>CLOCK:</b> On when real time clock is enabled.
11		<b>LIGHT:</b> On when the cabinet lighting is activated.
12		<b>SERVICE:</b> Flashes in the event of malfunctions.
13	<b>88.8</b>	<b>DISPLAY:</b> Shows the cabinet temperature.
14	<b>HACCP</b>	<b>HACCP:</b> n.a.
15		<b>CONTINUOUS CYCLE:</b> On when freezer is running in continuous run mode.

**Defrost** To ensure efficient operation, the electronic controller forces a defrost cycle when required. During a defrost cycle, the compressor stops, **DEF** and the ❄️ will display on the electronic controller faceplate. The freezer will resume normal operation once the defrost cycle has finished. A manual defrost can also be initiated by pressing and holding the  $\frac{def}{\nabla}$  button.

**Continuous Cycle** The continuous cycle can be used to pull down the temperature of product inside the freezer quickly. During a continuous cool down the compressor runs continuously for a set time.

**To start a continuous cycle**

1. While the freezer is switched on and running, press and hold the  $\frac{aux}{\blacktriangle}$  and  $\frac{def}{\blacktriangledown}$  buttons for five seconds.

The ❄️ symbol will display during a continuous cycle.

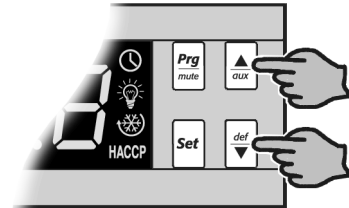

**To stop a continuous cycle**

1. The electronic controller will automatically stop the continuous cycle after a period of time.

The continuous cycle can be stopped by pressing and holding the  $\frac{aux}{\blacktriangle}$  and  $\frac{def}{\blacktriangledown}$  buttons for five seconds.

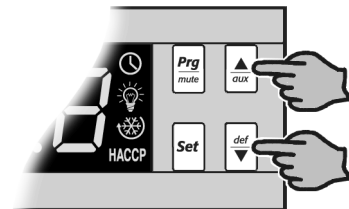

**Temperature Setpoint** The VF Freezer Range is manufactured with a pre-set control temperature set point of -21°C. If this set point does not match your required storage temperature it is recommended that you change the set point accordingly. The set point can be adjusted between -26°C and -16°C.

**To view and adjust the temperature setpoint**

1. To view the setpoint: press and hold the **Set** key for 2 seconds, until the setpoint value flashes

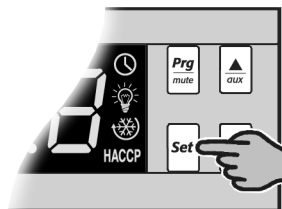

2. To adjust the setpoint: press either the  $\frac{aux}{\blacktriangle}$  and  $\frac{def}{\blacktriangledown}$  keys to display the required setpoint value.

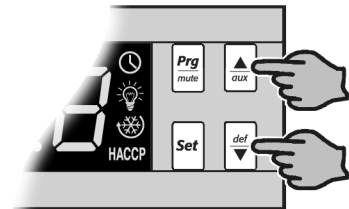

3. Press the **Set** key again to memorise the new setpoint value. If this is not done within 60 seconds, changes will be lost and you will need to repeat the above procedure.

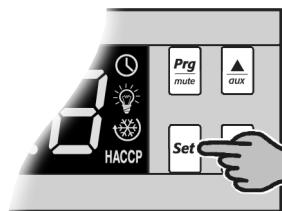

**Controller Reset** To delete program modifications and reset the controller to SKOPE default program or when a replacement controller is being fitted, a 'Controller Reset' must be performed.

**To reset the controller**

1. Disconnect the freezer from the power supply.

2. Press and hold the **Prg mute** key while plugging the freezer into the power supply (this may require two people). After a few seconds the controller is reset and program mode '**bn0**' is displayed. The controller must never be left in program mode '**bn0**' as failure will occur.

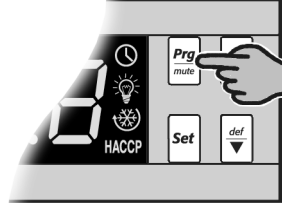



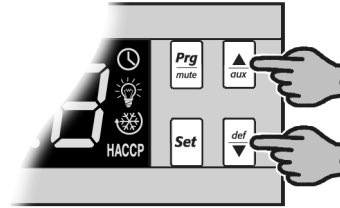



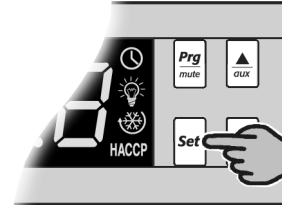



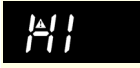



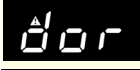









3. Press the **aux** or **def** keys to select '**bn1**' for SKOPE default program.

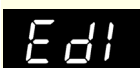

4. Immediately press the **Set** key to confirm the preferred program. If not confirmed within 60 seconds the freezer will remain in program mode '**bn0**' (and cause failure). If this occurs, repeat the above procedure.



**Alarms** The following table explains messages that the electronic controller displays and related alarms. Alarms signal unexpected operational changes in the freezer and stop when action is taken to resolve the problem.

Code	Display Icon	Alarm Description	Initial Action
	 Flashing	Product HIGH temperature alarm	1. Check the cabinet product loading to ensure ventilation slots are not blocked and that product does not overhang the shelves. 2. Ensure the cabinet is installed with good refrigeration unit ventilation. 3. Check and clean the condenser coil (see page 14). 4. Unplug cabinet from the power supply for 1 minute, then reconnect to power supply. If problems persist, contact SKOPE
	 Flashing	Product LOW temperature alarm	
	 Flashing	Door open alarm	Check door is closed.
	 Flashing	High ambient alarm	Check ventilation and operating conditions (see page 5).
	 Flashing	High pressure alarm	Check and clean the condenser coil (see page 14).
	 Flashing	Control probe fault	Contact an authorised service agent to replace probe.
	 Flashing	Evaporator probe fault	
	 Flashing	Ambient probe fault	
	None	Defrost over-time limit	Unplug cabinet from the power supply for 1 minute, then reconnect to power supply.
	 Flashing	Real-time clock fault	
	 Flashing	Controller E prom error	
	 Flashing	Controller E prom error	If problems persist, contact an authorised service agent.
	None	Start defrost request	None
	None	End defrost request	

## 3 Servicing

### Cleaning

Ensure the freezer is disconnected from the power supply before cleaning.

**WARNING**

Twin unit freezers have two separate power supplies. Ensure both supplies are disconnected before undertaking any service or maintenance work.

**Cabinet** Periodically wipe the inside and outside of the cabinet a cloth and warm soapy water, taking care to keep moisture away from electrical parts. Do not use solvents.

**Condenser Coil & Filter** To ensure trouble-free performance, we strongly urge monthly cleaning with a soft brush to remove dust and fluff. A more thorough cleaning is required by qualified service personnel every six months. The condenser and filter **must** be kept clean for efficient and reliable operation.

The condenser coil is located behind the sign, on the front of the refrigeration unit. The optional filter/s are located behind the top panel grille, in front of the condenser coil.

The optional filter is disposable and should be replaced when it shows signs of wear. Do **not** apply hot water, blow dry or place in dishwasher.

**WARNING**

Disconnect the freezer from the power supply before cleaning the condenser coil.

#### To clean the optional filter/s

1. Disconnect the freezer from the power supply.
2. Lift the grille up and out of the top panel to gain access to the condenser filter/s.  
To remove a filter, use the finger loops to pull the filter up and detach from the top panel.

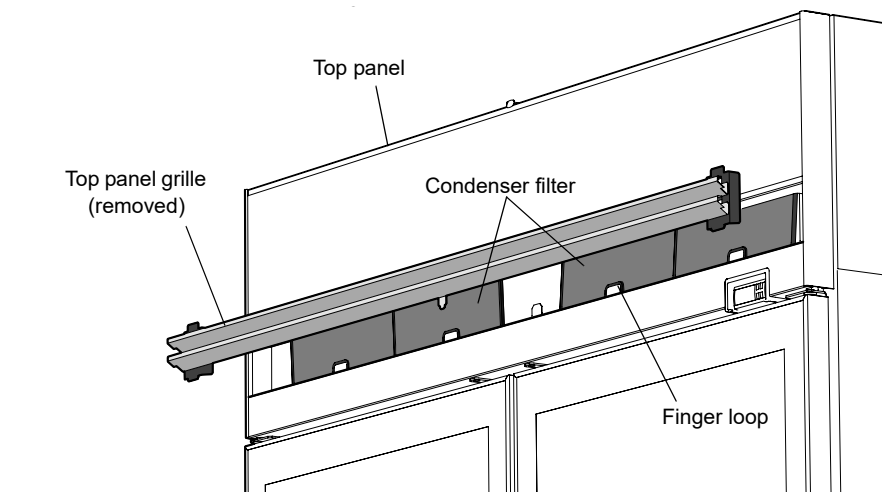

*Continued over page*

4. Clean the filter with a vacuum cleaner, wash with cold water and shake excess water off before refitting. Do not apply hot water, blow dry or place in dishwasher. If necessary, discard and refit new air filter.
5. To refit the filter, insert it up into the top panel with the finger loops facing out. Then clip the into the slots on the bottom face of the top panel.
6. Refit the grill to the top panel.

---

**To clean the condenser coil**

---

1. Disconnect the freezer from the power supply.
2. Remove the front panel from the top of the cabinet by pushing it up, swinging it out and lifting it off. Lit sign front panels will also need to be unplugged.
3. Brush the condenser coil with a soft brush to remove any dust and fluff.

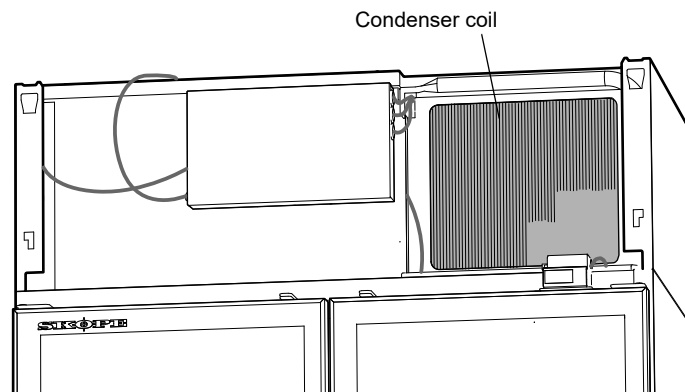

4. Refit the sign panel and reconnect the freezer to the power supply.
- 
- 

---

**Lighting**

---

In the event of light failure, a service call should be arranged so that a replacement light can be fitted.

## Troubleshooting

For questions about the electronic controller, see page 13. For problems with the cabinet and refrigeration cassette, use the following table.

Problem	Possible Cause	Suggestions
<ul style="list-style-type: none"> <li>• Cabinet not operating</li> <li>• No controller display</li> </ul>	<ul style="list-style-type: none"> <li>• Loss of power supply</li> </ul>	<ul style="list-style-type: none"> <li>• Check mains power supply.</li> </ul>
<ul style="list-style-type: none"> <li>• Light/s not functioning</li> </ul>	<ul style="list-style-type: none"> <li>• Lights switched off</li> <li>• Failed light</li> <li>• Blown cabinet fuse</li> </ul>	<ul style="list-style-type: none"> <li>• Switch lights on by pressing and holding UP/ Aux button on electronic controller faceplate.</li> <li>• Service call required</li> <li>• Service call required</li> </ul>
<ul style="list-style-type: none"> <li>• Power consumption is higher than expected</li> </ul>	<ul style="list-style-type: none"> <li>• Unit operating too hot</li> <li>• Cabinet doors are opened excessively</li> </ul>	<ul style="list-style-type: none"> <li>• Clean the condenser coil (see page 14).</li> <li>• Ensure the cabinet has good ventilation around the refrigeration unit (see page 5).</li> <li>• Ensure the cabinet is in a cool spot.</li> <li>• Ensure doors are closed more often.</li> </ul>
<ul style="list-style-type: none"> <li>• Product is too warm</li> </ul>	<ul style="list-style-type: none"> <li>• Restricted airflow to cabinet</li> </ul>	<ul style="list-style-type: none"> <li>• Ensure product is not blocking airflow slots.</li> <li>• Ensure there is space around individual product pieces.</li> </ul>
<ul style="list-style-type: none"> <li>• Warm cabinet temperatures</li> <li>• Compressor operating for long periods (more than 1 hour)</li> </ul>	<ul style="list-style-type: none"> <li>• Blocked condenser</li> <li>• Poor ventilation around refrigeration unit</li> </ul>	<ul style="list-style-type: none"> <li>• Clean the condenser coil (see page 14).</li> <li>• Ensure the cabinet has good ventilation around the refrigeration unit (see page 5).</li> </ul>



## SKOPE Industries Limited

### NEW ZEALAND CONTACT

Head Office  
PO Box 1091, Christchurch  
New Zealand  
Freephone: 0800 947 5673  
Fax: (03) 983 3896  
E-mail: [enquiry@skope.co.nz](mailto:enquiry@skope.co.nz)  
Website: [www.skope.co.nz](http://www.skope.co.nz)

### AUSTRALIAN CONTACT

A.B.N. 73 374 418 306  
PO Box 7543, Baulkham Hills B.C.  
NSW 2153, Australia  
Freephone: 1800 121 535  
Fax: 1800 121 533  
E-mail: [enquiry@skope.com.au](mailto:enquiry@skope.com.au)  
Website: [www.skope.com.au](http://www.skope.com.au)

## Trademark Infringement

The SKOPE trademark on this product is infringed if the owner, for the time being, does any of the following:

- Applies the trade mark to the product after their state, condition, get-up or packaging has been altered in any manner
- Alters, removes (including part removal) or obliterates (including part obliteration) the trade mark on the product
- Applies any other trade mark to the product
- Adds to the product any written material that is likely to damage the reputation of the trade mark

Notice of the above contractual obligations passes to:

- Successors or assignees of the buyer
- Future owners of the product

VF-X Series  
SKOPE Vertical Freezer  
User Manual

MAN11137  
Rev.1.1 Sep. 2016

© 2016 SKOPE Industries Limited. All rights reserved.  
SKOPE Industries Limited reserve the right to alter specifications without notice.

**SKOPE**® is a registered trademark of SKOPE Industries Limited.