



ItalianGelato
Concepts

dessert projects & equipment supply

Ph: +61 (0) 7 3162 7724

info@italiangelato.com.au



ICE VISION

SIRIUS



SOLUZIONI D'ARREDO PER FOOD & BEVERAGE

Il freddo e' il nostro habitat

SIRIUS



SIRIUS TR

Con piano espositivo e vaschette trasparenti
With display surface and transparent containers
Mit Ausstellungsfläche und durchsichtigen Schalen
Avec barquettes et plan d'exposition transparents



ItalianGelato
Concepts
dessert projects & equipment supply

Ph: +61 (0) 7 3162 7724 www.italiangelato.com.au

SIRIUS

Gelato Pastry

A new way to present and enhance your art.

The SIRIUS model has given life to an articulated range of ice-cream and pastry shop display cases, the result of careful study in each component. This has made it possible to create ideal systems to enhance the visibility of the showcased products, making them the true protagonists thanks to the raised, illuminated display floor.

The fully hermetic glass superstructure structured with double glass guarantees safe energy savings and can work even in critical weather conditions. In ice-cream shop units, the container position is perfectly horizontal for convenient ice-cream scooping. The SIRIUS ice-cream shop range is also designed for the addition of clear containers to further enhance the displayed ice-cream.

- One-piece shell with 60 mm-thick polyurethane insulation, AISI 304 stainless steel tank.
- LED lighting.
- Anti-condensation heated double glass superstructure, vent-opening front glass, service side closure with sliding glass doors on telescopic side guides.
- Ventilated refrigeration with double evaporators.
- Double hermetic compressor V230/1 (in models 18 and 24) for optimal refrigeration performance with low noise level
- Optional compressor 400/3.
- Removable condensing unit for easier, faster maintenance.
- Automatic ultra-fast reverse cycle defrost.
- Electronic control panel for temperature adjustment.
- Climate class 7 (35°/ 75% UR).



ItalianGelato
Concepts
dessert projects & equipment supply



Versione trasparente OPTIONAL
Transparent version OPTIONAL
Durchsichtige Ausführung OPTIONAL
Version transparente OPTIONNELLE



REFRIGERAZIONE VENTILATA
VENTILATED REFRIGERATION
UMLUFTKÜHLUNG
RÉFRIGÉRATION VENTILÉE



DATI TECNICI / TECHNICAL DATA / TECHNISCHE DATEN / DONNEES TECHNIQUES

MOD.									 °C	POTENZA COMPRESSORE / POWER COMPRESSOR PUISSANCE COMPRESSEUR / LEISTUNG VERDICHTER						N. Classe climatica No. Climate class Klimaklasse N° Classe climatique N° (C°/%UR)
	L	P	H	kg	L	P	H	kg		Monofase / Single-phase / Einphasig / Monophasé		Trifase / Three-phase / Dreiphasig / Triphasé				
	[cm]	[cm]	[cm]	[kg]	[cm]	[cm]	[cm]	[kg]		Tensione Supply Spannung Tension	Regime Output Verhältnis Régime	Sbrinamento In Defrost Zeitgesteuerte Dégivrage	Tensione Supply Spannung Tension	Regime Output Verhältnis Régime	Sbrinamento In Defrost Zeitgesteuerte Dégivrage	
SIRIUS GELATO 12	117	108	118	245	127	124	152	285	-16 / -18	230/1/50	1.19	2.6	400/3/50	1.3	2.52	7 (35/75)
SIRIUS GELATO 18	167	108	118	335	177	124	152	380	-16 / -18	230/1/50	2.08	3.53	400/3/50	1.97	3.87	7 (35/75)
SIRIUS GELATO 24	221	108	118	400	231	124	152	470	-16 / -18	230/1/50	2.5	3.8	400/3/50	2.8	5.1	7 (35/75)



ItalianGelato
Concepts
dessert projects & equipment supply

H118

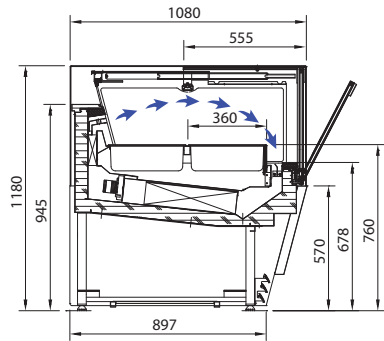

Base / Basic
Basis / Base

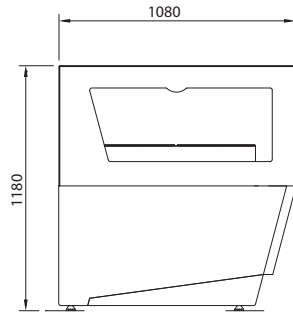

Pannellata / With panels
Mit Paneelen / Avec des panneaux



SIRIUS GELATO 12

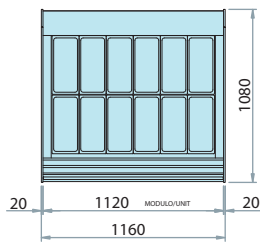

SIRIUS GELATO 18

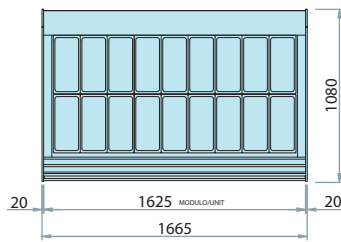

SIRIUS GELATO 24

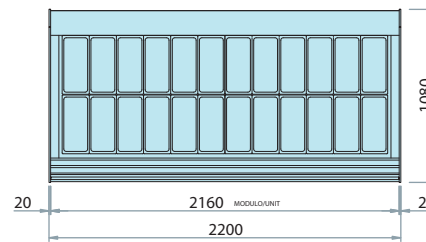

STANDARD L x P x H
360 x 165 x 120 [5Lt.]

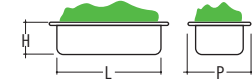

LARGE L x P x H
360 x 250 x 80 [5Lt.]
360 x 250 x 120 [7Lt.]

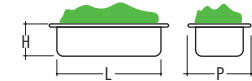

COLOURS



The showcase can be customized in colors according to available RAL.

STANDARD

Electronic control unit / R452A refrigerant gas



Italian Gelato Concepts Pty Limited
Unit 1, 37 Mortimer Road
Acacia Ridge Qld 4110

Bris Office: +61 [0] 7 3162 7724
Syd Office +61 [0] 2 8311 9701
Email: info@italiangelato.com.au

www.italiangelato.com.au



SOLUZIONI D'ARREDO PER FOOD & BEVERAGE

AF DESIGN 0118 - ICEVISION