



ICE VISION ION

POZZETTI



SOLUZIONI D'ARREDO PER FOOD & BEVERAGE

Il freddo e' il nostro habitat

OMNIA



SMOOTH



POZZETTI e TOPPING

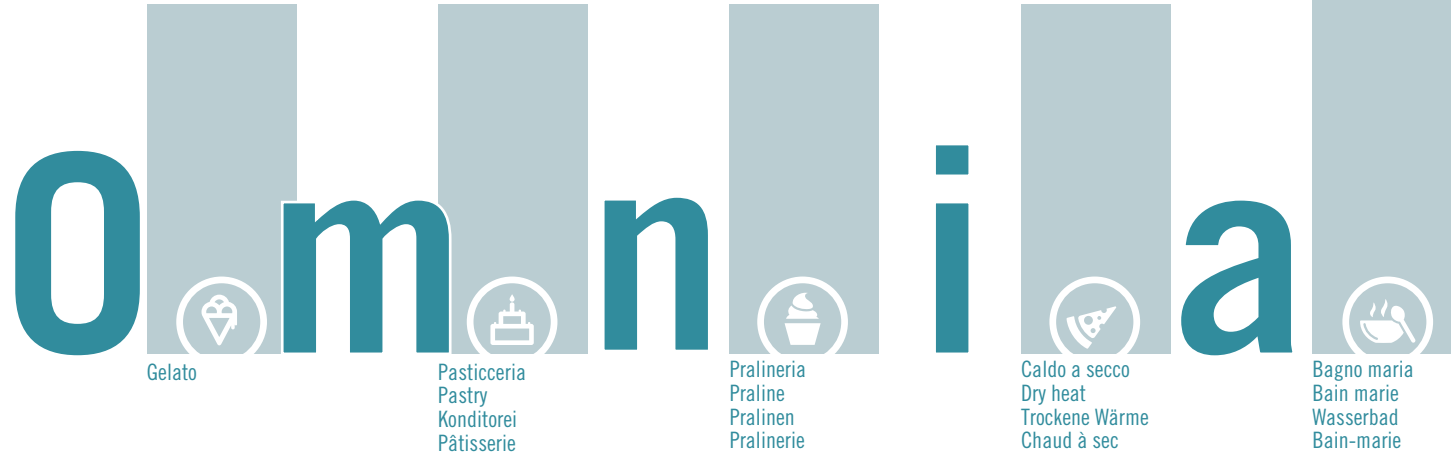

IT

Uno stile minimale e duttile capace di offrire alla clientela del locale tutto ciò che serve. Questa è l'opera OMNIA di Ital Proget; una proposta completa, un concept, un modo di pensare il proprio locale, essenziale nei tratti e nel modo di porsi ma allo stesso tempo, abile nel soddisfare in maniera ottimale l'esigenza di mostrare tutti i prodotti valorizzando il loro lato migliore: SMOOTH, POZZETTI, TOPPING questi i moduli che la compongono.

EN

A minimal, ductile style able to offer customers everything they may need. This is OMNIA by Ital Proget: a complete offer, a new concept, a fresh way of looking at your establishment. With minimalist lines and way of presenting itself but, at the same time, able to fully satisfy all product display needs, enhancing their best side. This case is composed of the SMOOTH, POZZETTI, TOPPING units.

DE

Ein minimalistischer und anpassungsfähiger Stil mit der Fähigkeit, den Kunden des Lokals all das zu bieten, was erforderlich ist. Das ist OMNIA von Ital Proget; ein komplettes Angebot, ein Konzept und eine Vision des zigenen Lokals, nüchtern und wesentlich im Stil, aber gleichzeitig dazu in der Lage, auf perfekte Weise sämtliche Produkte von ihrer besten Seite zu zeigen: SMOOTH, POZZETTI, TOPPING sind die verfügbaren Modelle.

FR

Un style minimaliste et ductile en mesure d'offrir tout ce qui sert à la clientèle du lieu. Voici OMNIA, l'œuvre d'Ital Proget ; une proposition complète, un concept, une façon de penser son propre lieu, un produit essentiel dans les traits et dans la manière de se placer mais au même moment habile à satisfaire de la meilleure façon qu'il soit, l'exigence de montrer tous les produits en valorisant leur meilleur côté : SMOOTH, POZZETTI, TOPPING sont les modules qui la composent.



DATI TECNICI / TECHNICAL DATA / TECHNISCHE DATEN / DONNEES TECHNIQUES



MOD.										Resa frigo Refrigeration power Kühlschrank Ausbeute Rendement frigo	Tensione Supply Spannung Tension	Regime Output Verhältnis Régime	Potenza assorbita Electrical power output Absorbierte Leistung Puissance absorbée	N. Classe climatica No. Climate class Klimaklasse N° Classe climatique N°
	L	P	H	[kg]	L	P	H	[kg]						
CARAPINE 75	75	73	95 / 123	-	125	98	150	-	-5 / -18	-	230/1/50	0.4	1.48	4+(32/60)
CARAPINE 100	100	73	95 / 123	-	125	98	150	-	-5 / -18	-	230/1/50	0.5	3.1	4+(32/60)
CARAPINE 125	125	73	95 / 123	-	125	98	150	-	-5 / -18	-	230/1/50	0.56	3.1	4+(32/60)
CARAPINE 150	150	73	95 / 123	-	172	98	150	-	-5 / -18	-	230/1/50	0.6	3.7	4+(32/60)
CARAPINE 175	175	73	95 / 123	-	224	98	150	-	-5 / -18	-	230/1/50	0.64	4.1	4+(32/60)
CARAPINE 75	75	73	95 / 123	-	125	98	150	-	-5 / -18	-	230/1/50	0.85	4.1	4+(32/60)
CARAPINE 100	100	73	95 / 123	-	125	98	150	-	-5 / -18	-	230/1/50	1.02	5.1	4+(32/60)
CARAPINE 125	125	73	95 / 123	-	125	98	150	-	-5 / -18	-	230/1/50	1.1	6.5	4+(32/60)
CARAPINE 150	150	73	95 / 123	-	172	98	150	-	-5 / -18	-	230/1/50	1.1	6.5	4+(32/60)
CARAPINE 175	175	73	95 / 123	-	224	98	150	-	-5 / -18	-	230/1/50	1.37	6.5	4+(32/60)

STATICA
 STATIC
 STATISCH
 STATIQUE

VENTILATA
 VENTILATED
 UMLUFT
 VENTILÉE

GLICOLE
 GLYCOL
 GLYKOL
 GLYCOL

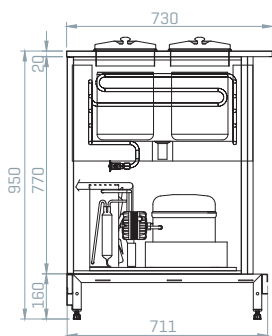

Base / Basic
Basis / Base

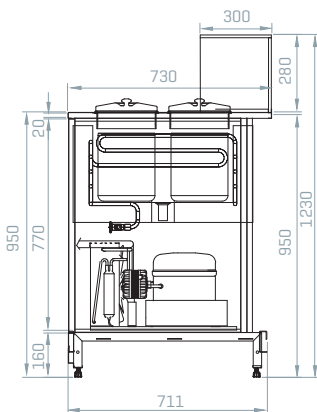

Pannellata / With panels
Mit Paneelen / Avec des panneaux

CARAPINE 75

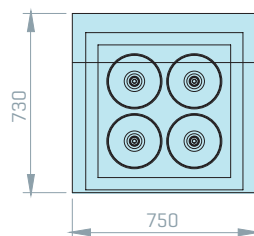

CARAPINE 100

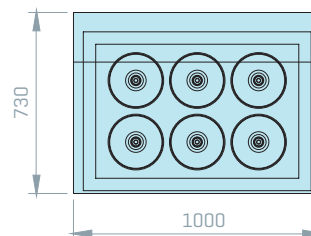

CARAPINE 125

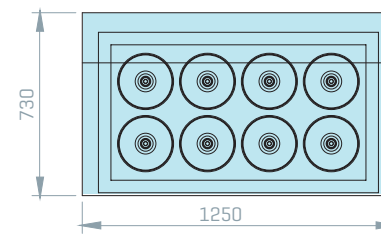

CARAPINE 150

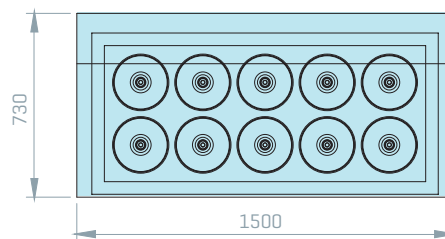

CARAPINE 175

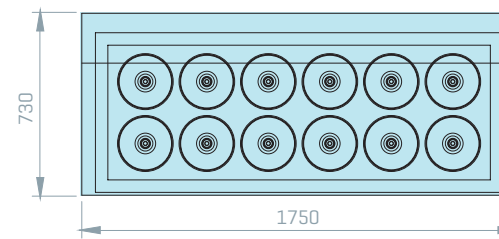

COLORI / COLOURS / FARBEN / COULEURS



Le vetrine possono essere personalizzate nei colori RAL in commercio.
The showcase can be customized in colors according to available RAL.
Die Vitrinen können in handelsüblichen RAL-Farben gestaltet werden.
Les vitrines peuvent être personnalisées selon les coloris RAL dans le commerce.



DATI TECNICI / TECHNICAL DATA / TECHNISCHE DATEN / DONNEES TECHNIQUES

MOD.										Resa frigo Refrigeration power Kühlschrank Ausbeute Rendement frigo	Tensione Supply Spannung Tension	Regime Output Verhältnis Régime	Potenza assorbita Electrical power output Absorbierte Leistung Puissance absorbée	N. Classe climatica No. Climate class Klimaklasse N° Classe climatique N°
	L	P	H		L	P	H							
CARAPINE 75BX	75	73	95 / 123	-	125	98	150	-	-5 / -18	-	230/1/50	0.4	3.1	4+(32/60)
CARAPINE 100BX	100	73	95 / 123	-	125	98	150	-	-5 / -18	-	230/1/50	0.6	3.1	4+(32/60)
CARAPINE 125BX	125	73	95 / 123	-	125	98	150	-	-5 / -18	-	230/1/50	0.9	3.7	4+(32/60)
CARAPINE 150BX	150	73	95 / 123	-	172	98	150	-	-5 / -18	-	230/1/50	1.09	4.8	4+(32/60)
CARAPINE 175BX	175	73	95 / 123	-	224	98	150	-	-5 / -18	-	230/1/50	1.37	5.1	4+(32/60)
CARAPINE 75BX	75	73	95 / 123	-	125	98	150	-	-5 / -18	-	230/1/50	0.85	4.1	4+(32/60)
CARAPINE 100BX	100	73	95 / 123	-	125	98	150	-	-5 / -18	-	230/1/50	1.02	5.1	4+(32/60)
CARAPINE 125BX	125	73	95 / 123	-	125	98	150	-	-5 / -18	-	230/1/50	1.1	6.5	4+(32/60)
CARAPINE 150BX	150	73	95 / 123	-	172	98	150	-	-5 / -18	-	230/1/50	1.1	6.5	4+(32/60)
CARAPINE 175BX	175	73	95 / 123	-	224	98	150	-	-5 / -18	-	230/1/50	1.37	6.5	4+(32/60)



STATICA
STATIC
STATISCH
STATIQUE



VENTILATA
VENTILATED
UMLUFT
VENTILÉE



GLICOLE
GLYCOL
GLYKOL
GLYCOL

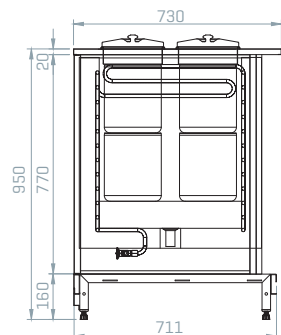

Base / Basic
Basis / Base

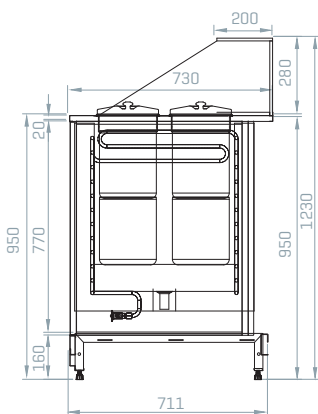

Pannellata / With panels
Mit Paneelen / Avec des panneaux

CARAPINE 75BX

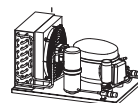
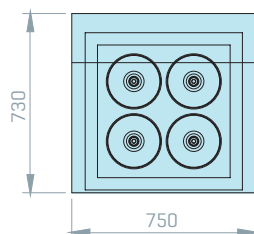

CARAPINE 100BX

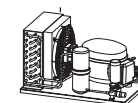
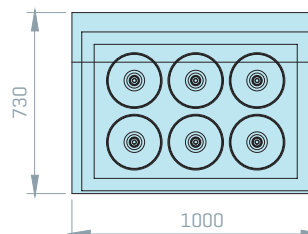

CARAPINE 125BX

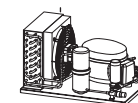
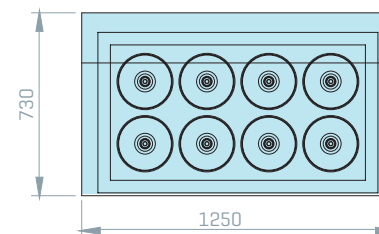

CARAPINE 150BX

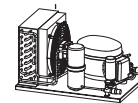
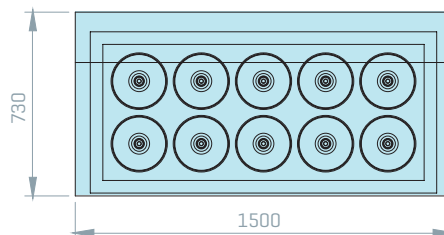

CARAPINE 175BX

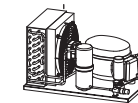
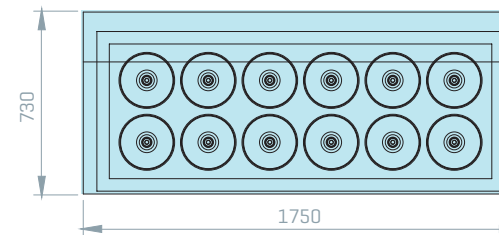

COLORI / COLOURS / FARBEN / COULEURS



Le vetrine possono essere personalizzate nei colori RAL in commercio.
The showcase can be customized in colors according to available RAL.
Die Vitrinen können in handelsüblichen RAL-Farben gestaltet werden.
Les vitrines peuvent être personnalisées selon les coloris RAL dans le commerce.



DATI TECNICI / TECHNICAL DATA / TECHNISCHE DATEN / DONNEES TECHNIQUES

MOD.										Resa frigo Refrigeration power Kühlschrank Ausbeute Rendement frigo	Tensione Supply Spannung Tension	Regime Output Verhältnis Régime	Potenza assorbita Electrical power output Absorbierte Leistung Puissance absorbée	N. Classe climatica No. Climate class Klimaklasse N° Classe climatique N°
	L	P	H	[kg]	L	P	H	[kg]						
CARAPINE 125B	125	73	95 / 123	-	125	98	150	-	-5 / -18	-	230/1/50	0.4	3.1	4+(32/60)
CARAPINE 150B	150	73	95 / 123	-	172	98	150	-	-5 / -18	-	230/1/50	0.6	3.1	4+(32/60)
CARAPINE 175B	175	73	95 / 123	-	224	98	150	-	-5 / -18	-	230/1/50	0.9	3.7	4+(32/60)
CARAPINE 200B	200	73	95 / 123	-	224	98	150	-	-5 / -18	-	230/1/50	1.09	4.8	4+(32/60)
CARAPINE 225B	225	73	95 / 123	-	224	98	150	-	-5 / -18	-	230/1/50	1.37	5.1	4+(32/60)
CARAPINE 125B	125	73	95 / 123	-	125	98	150	-	-5 / -18	-	230/1/50	0.85	4.1	4+(32/60)
CARAPINE 150B	150	73	95 / 123	-	172	98	150	-	-5 / -18	-	230/1/50	1.02	5.1	4+(32/60)
CARAPINE 175B	175	73	95 / 123	-	224	98	150	-	-5 / -18	-	230/1/50	1.1	6.5	4+(32/60)
CARAPINE 200B	200	73	95 / 123	-	224	98	150	-	-5 / -18	-	230/1/50	1.1	6.5	4+(32/60)
CARAPINE 225B	225	73	95 / 123	-	224	98	150	-	-5 / -18	-	230/1/50	1.37	6.5	4+(32/60)



STATICA
STATIC
STATISCH
STATIQUE



VENTILATA
VENTILATED
UMLUFT
VENTILÉE



GLICOLE
GLYCOL
GLYKOL
GLYCOL

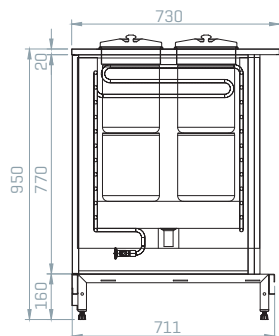

Base / Basic
Basis / Base

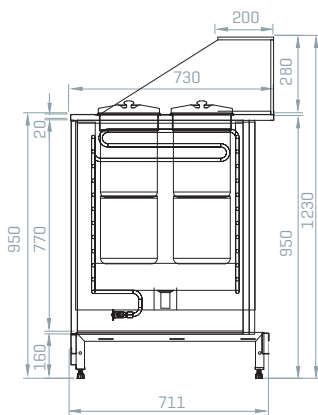

Pannellata / With panels
Mit Paneelen / Avec des panneaux

CARAPINE 125B

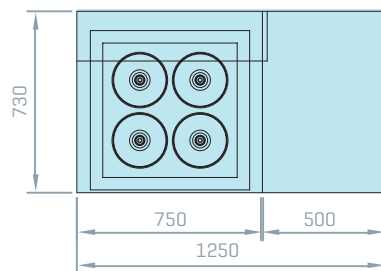

CARAPINE 150B

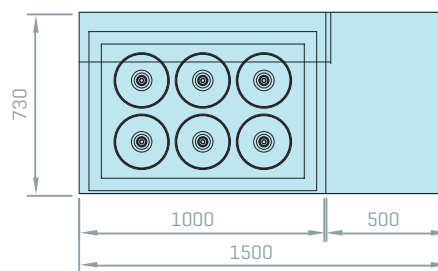

CARAPINE 175B

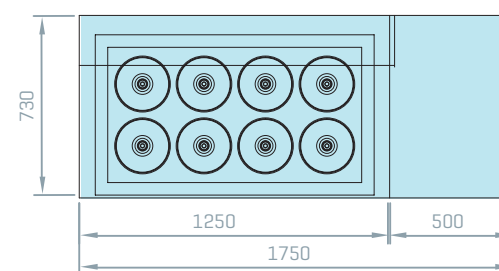

CARAPINE 200B

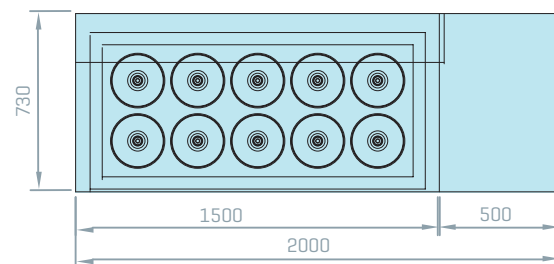

CARAPINE 225B

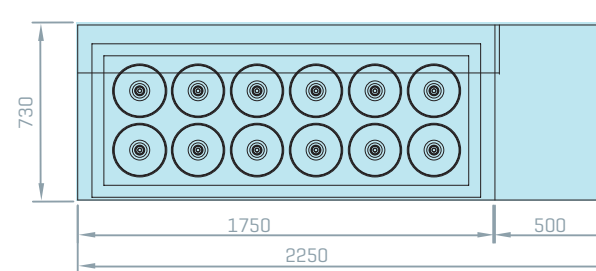

COLORI / COLOURS / FARBEN / COULEURS



Le vetrine possono essere personalizzate nei colori RAL in commercio.
The showcase can be customized in colors according to available RAL.
Die Vitrinen können in handelsüblichen RAL-Farben gestaltet werden.
Les vitrines peuvent être personnalisées selon les coloris RAL dans le commerce.



Italian Gelato Concepts Pty Limited
Unit 1, 37 Mortimer Road
Acacia Ridge Qld 4110

Bris Office: +61 [0] 7 3162 7724
Syd Office +61 [0] 2 8311 9701
Email: info@italiangelato.com.au

www.italiangelato.com.au



SOLUZIONI D'ARREDO PER FOOD & BEVERAGE

AF DESIGN 0118 - ICEVISION