

Mixing with New-Generation Torque Rheometer Drives

Brabender: MetaStation Series



Today's Configuration Flexibility, Tomorrow's Infinite Possibilities

Determine the processability and characteristics of plastics and plastifiable substances

The MetaStation series is the latest generation of modular torque rheometer drives for use with mixers, and single-screw and twin-screw extruders. The modular concept of the MetaStation attachments enables you to tailor the instrument to your specific applications such as testing of PVC, rubber and thermosets. Switch between modules in less than 15 minutes and quickly cover a wide array of applications. Equipped with the industry's leading operating software, MetaBridge, MetaStation delivers market-leading torque rheometry for 50+ standards.



FIND OUT MORE

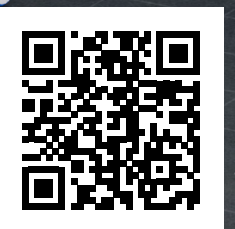

www.anton-paar.com/apb-metastation

Your advantages:

- ✓ The optimized mixer design makes opening, disassembly, material removal and cleaning easy. Cleaning is twice as fast compared to previous generations.
- ✓ Transfer your knowledge about the material processability from mixing to extrusion
- ✓ Access measurements from any device, export data and switch seamlessly between mixing and extrusion applications with the MetaBridge operating software
- ✓ Ensure continuous monitoring of material quality due to standards compliance according to ISO and ASTM

1

MetaStation 4

The most compact torque rheometer drive in the MetaStation series. Suitable for use as a tabletop unit or freestanding system. Particularly appropriate for application in the early phases of recipe development or for the preparation of small batch quantities.

2

MetaStation 8

The torque rheometer drive for mixtures with higher torque requirements, e.g. with higher viscosity of the tested material or a high filler content.

3

MetaStation 16

The most powerful drive in the MetaStation series for applications with increased requirements regarding the available maximum speed and torque.

Versatile Design, Huge Array of Applications

MetaStation – from the pioneers

We've pioneered the torque rheometer for mixing. Determine the miscibility of a material formulation or the forming behavior of plasticizable masses using MetaStation mixers:

- Develop materials, new formulations and recipes
- Optimize incoming goods and quality control
- Conduct pre-trials to define process parameters, as well as melting and curing behavior

Even more versatility

A wide array of steel alloys and coating materials for the mixer ensures consistently high measuring accuracy and durability over the whole instrument life time – even with highly-corrosive and highly-abrasive substances.

To ensure optimal mixing properties, reduce human error, and enable convenient loading, we offer a portfolio of filling solutions for the mixer attachments.

The Brabender MetaStation with MB 30 mixer is the leading solution on the market, helping you to determine the crosslinking properties of thermosets according to DIN 53764.

Leverage the Plastogram

During the test, the stock temperature and the torque required for the mixing process are measured. The determined torque curves represent the resistance to deformation by the mixing blades and are directly related to the temperature and shear rate-dependent viscosity of the material. The Plastogram correlates structure and processing properties of the analyzed mixture.

Choose the mixing setup you need

Depending on the material or the required batch size, mixers from the MetaStation series are provided in different setups and with mixing chambers sized 30 cm³, 50 cm³, and 350 cm³.

Different types of material also require the possibility of applying different blade types, which can be easily replaced thanks to the modular design of the mixing chamber.

Tests on processability and mixing behavior can be carried out on different groups of materials:

- Thermoplastics
- PVC
- Thermosets
- Rubber compounds

Application	Blade type	Mixer size		
		30 cm ³	50 cm ³	350 cm ³
		↓	↓	↓
Thermoplastic	Roller (W)	✓	✓	✓
Rubber compounds, elastomers	Cam (N)		✓	✓
	Banbury (B)		✓	✓
PVC dry blends	Sigma (S)		✓	✓
Thermosets	Delta (MB)	✓		



Thermoplastics

As you pursue cutting-edge development of thermoplastic materials, incorporating transformative additives into the base polymer, understanding your material's processability is vital for unparalleled performance.

The MetaStation Mixer is your indispensable tool for overcoming the challenges of integrating fillers or reinforcing particles, ensuring a smooth journey towards manufacturing high-performance thermoplastic solutions tailored to your needs.

- Melting behavior
- Thermal and shear stability
- Effect of additives
- Degradation

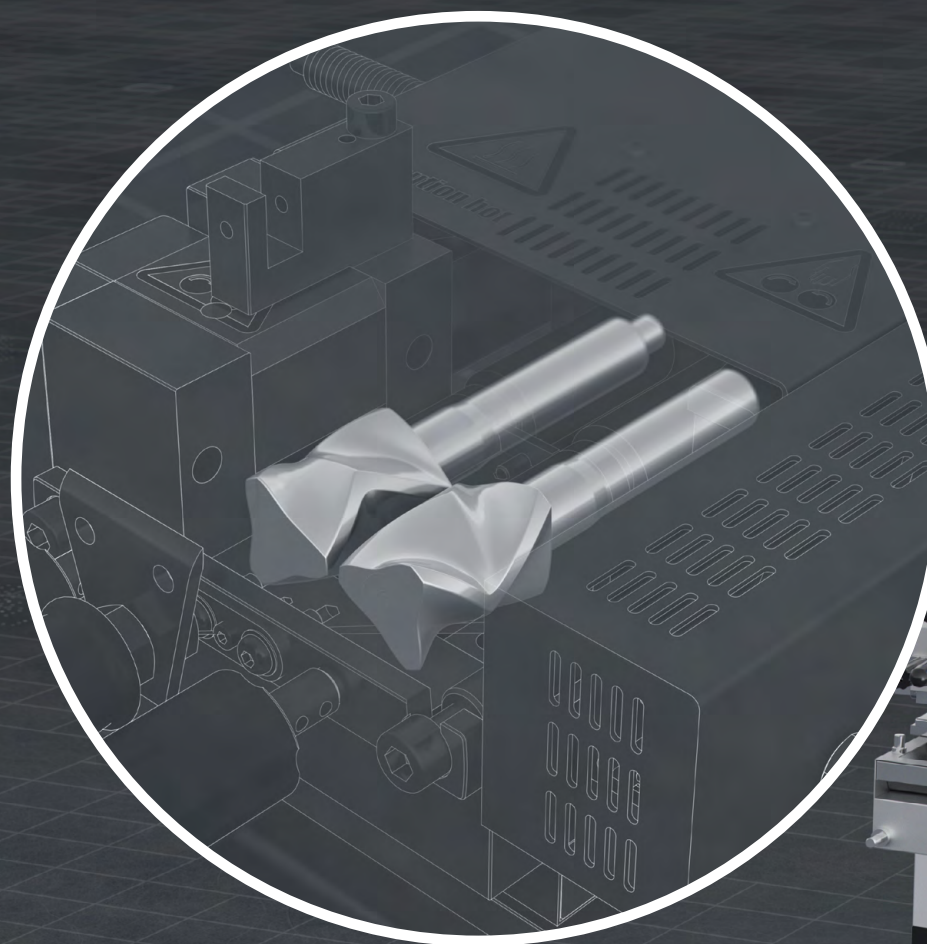

Mixer type ¹	Volume	Sample weight	Max. temperature	MetaStation		
				4	8	16
				↓	↓	↓
W 30 EHT	30 cm ³	25 g – 40 g	500 °C	✓	✓	
W 50 EHT	50 cm ³	40 g – 70 g	500 °C	✓	✓	
W 350 E	350 cm ³	250 g – 500 g	300 °C		✓	✓

¹ EHT (electrical, high temperature) – variant with electric heating and air cooling instead of liquid temperature control
 E (electrical) – variant with electric heating and air cooling instead of liquid temperature control

Know more about your thermoplastics material by expertly navigating challenges such as temperature and shear sensitivity, along with degradation risks and complex rheology.

With precise characterization of key properties like viscosity, thermal stability, and melt strength, you'll achieve superior process control, optimized product quality, and tailored material selection for a range of applications.

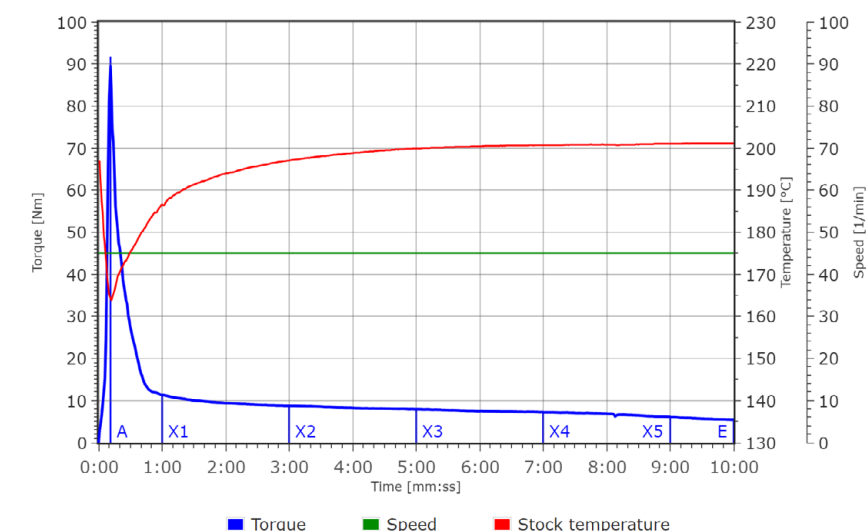

PVC

Navigating the shear sensitivity of polyvinyl chloride (PVC) requires specialized processing techniques, which MetaStation mixers uniquely provide. These tools are essential for the precise characterization and optimization of PVC blends. They're your pathway to enhanced performance and quality via material-specific testing methods.

- Melting behavior
- Thermal and shear stability
- Effect of additives
- Degradation

Perform advanced mixing with the MetaStation series' P600 planetary mixer attachment – alongside the 30 cc, 50 cc, and 350 cc mixer attachments. The P600 excels in:

- Fluid absorption
- Powder dry time
- Pourability of dry blends
- PVC paste preparation



Mixer type	Volume	Sample weight	Max. temperature	MetaStation		
				4	8	16
W 30 EHT	30 cm ³	25 g – 40 g	500 °C	↓	↓	↓
W 50 EHT	50 cm ³	40 g – 70 g	500 °C	✓	✓	
W 350 E	350 cm ³	250 g – 500 g	300 °C		✓	✓

Optimize PVC characterization with the MetaStation mixers, designed for the complex nature of PVC and their sensitivity to temperature and shear forces during mixing. Precisely control key properties like viscosity and thermal stability or filler and plasticizer dispersion, enhancing processing, product quality, and reducing waste. Craft specialized PVC compounds, maximizing performance and sustainability in various industries.

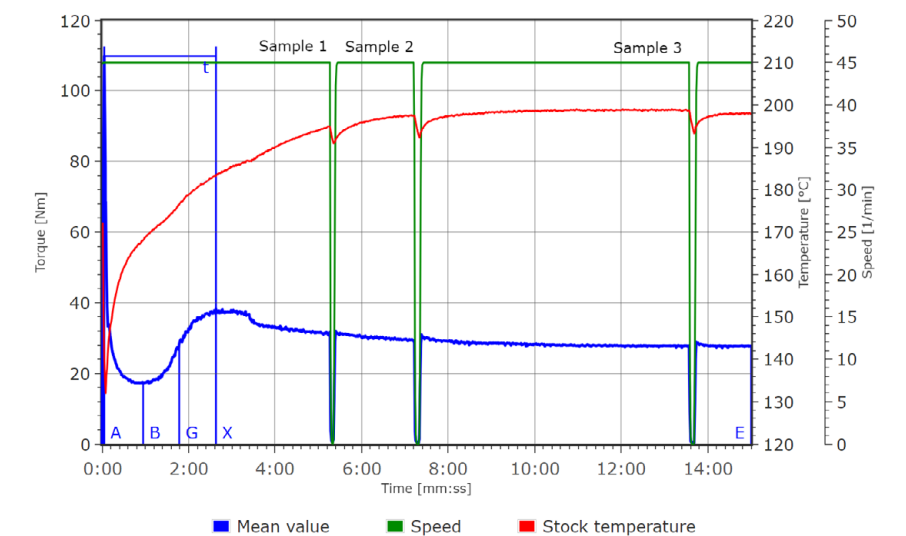

Elastomers

Optimize your elastomer and rubber compound investigation with the MetaStation mixer series. The 30 cc and 50 cc models with Cam (N) and Banbury (B) blades, alongside the specialized 350 E and 350 S elastomer mixers, are your gateway to exploring the impact of additives and fillers on mixing and vulcanization. The standout 350 SX variant, with its intermeshing blade arrangement, promises an increased mixing effect, ensuring thorough integration and superb results.

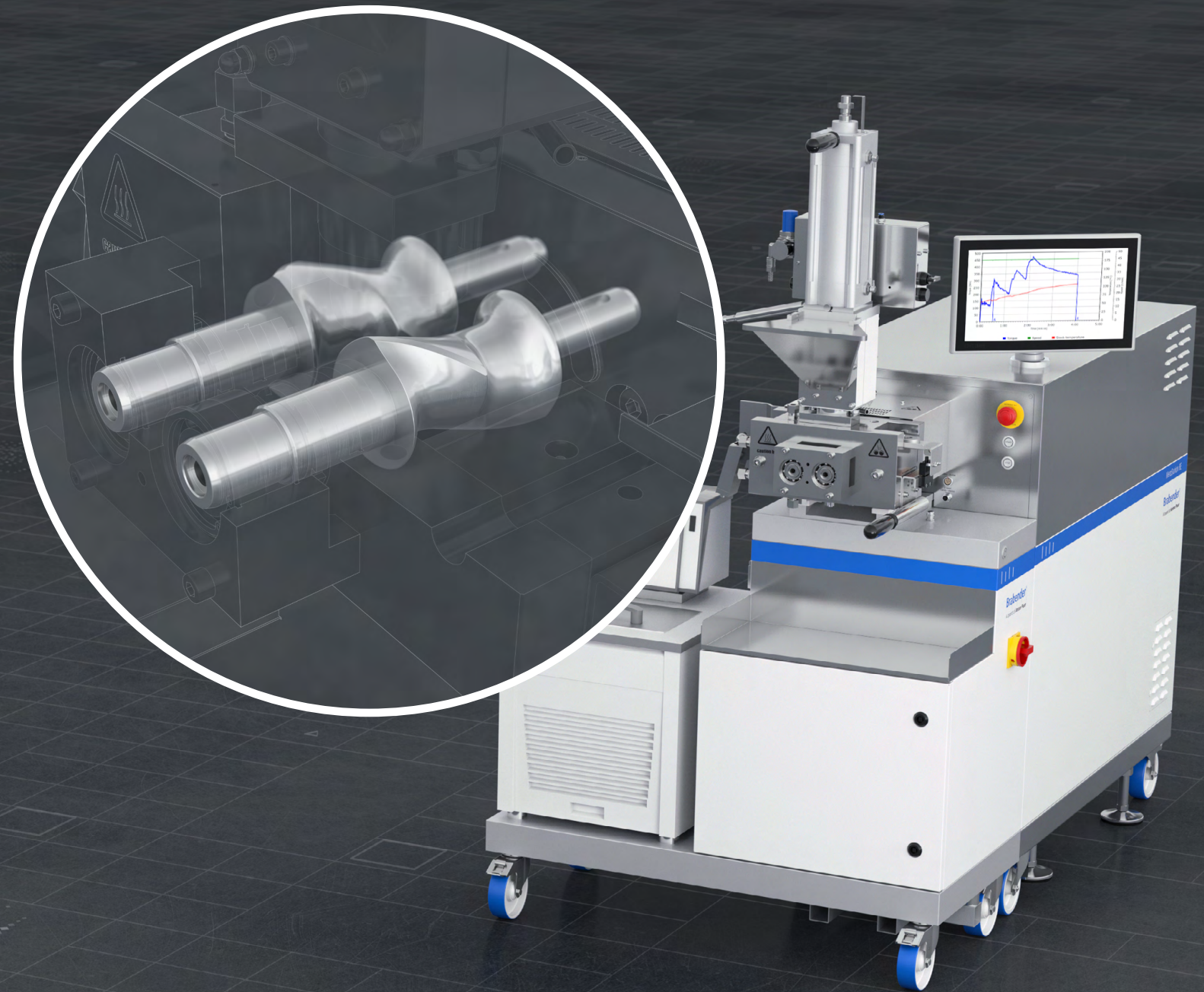

Mixer type	Volume	Sample weight	Max. temperature	MetaStation		
				4	8	16
B 50 EHT	50 cm ³	40 g – 80 g	500 °C	↓	↓	↓
N 50 EHT	50 cm ³	40 g – 80 g	500 °C	✓	✓	
350 E	350 cm ³	250 g – 500 g	300 °C		✓	✓
B 350 S	390 cm ³	250 g – 500 g	300 °C		✓	✓
350 SX	318 cm ³	200 g – 400 g	250 °C			✓

Improve elastomer characterization, addressing complex formulations, viscoelastic properties, and curing behavior. Optimize processes, augment quality, and reduce waste by precisely analyzing rheology, cure characteristics, and filler dispersion. MetaStation enables tailored compounds for peak performance and sustainability.

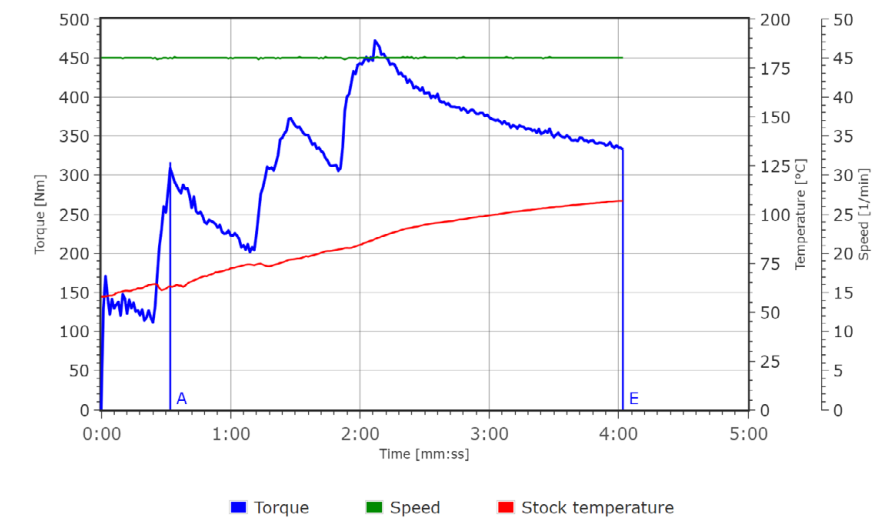

Thermosets

Perform thermoset material studies focusing on curing behavior rather than melting. The temperature-controlled mixer with specialized delta-shaped blades (MB type) ensures precise torque measurements throughout the cross-linking reaction until full cure.

- Reaction time and pot life
- Conversion-related change in torque / viscosity
- Temperature-dependent reaction kinetics

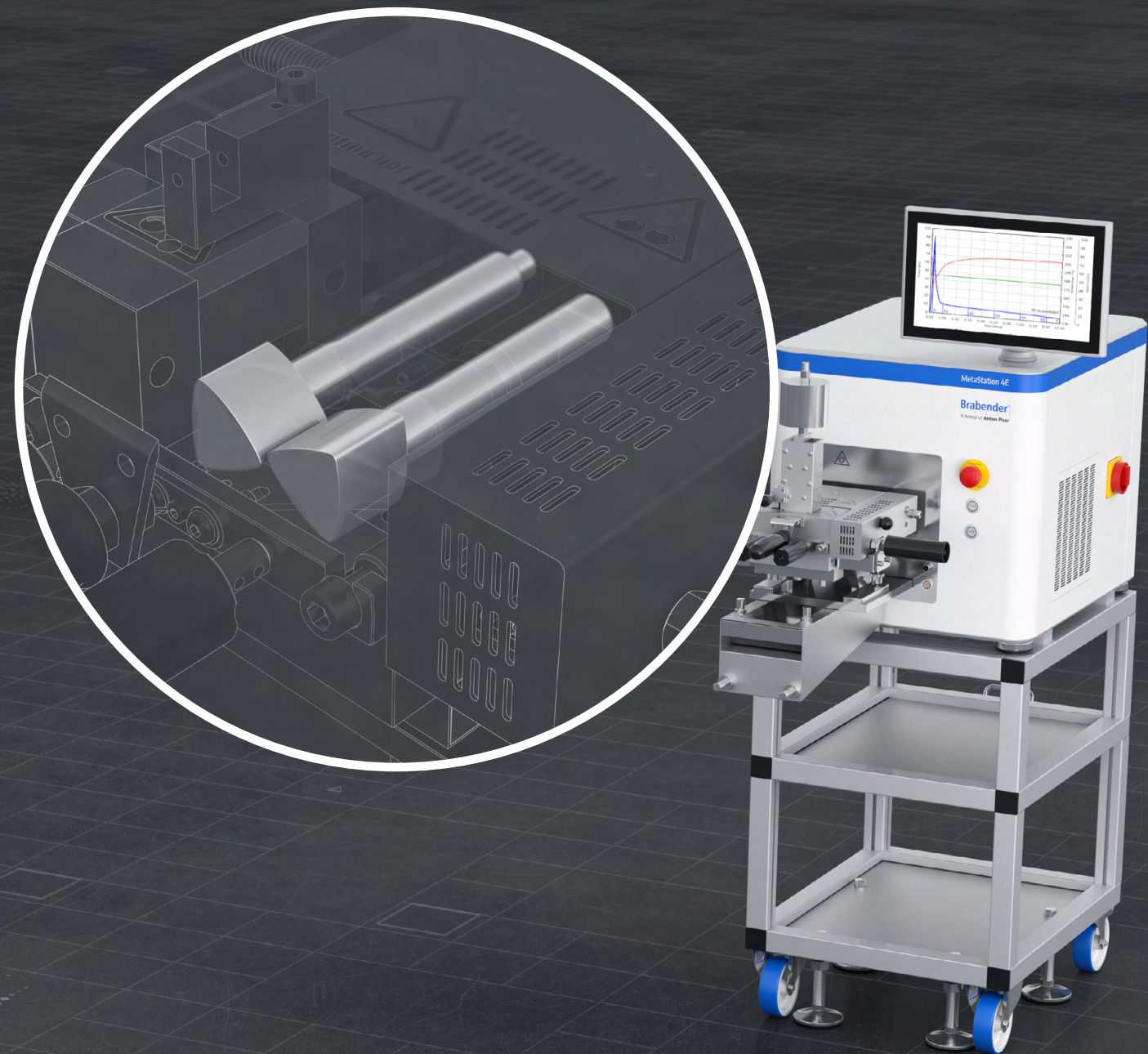

Mixer type	Volume	Sample weight	Max. temperature	MetaStation		
				4	8	16
MB 30	30 cm ³	20 g – 40 g	300 °C	↓	↓	↓
				✓	✓	

Master thermoset characterization, tackling complex curing, high viscosity, and reactivity. By precisely measuring key properties like viscosity and curing kinetics, you optimize curing conditions, improve formulations, and drive up product performance, leading to reduced waste and more efficient manufacturing.

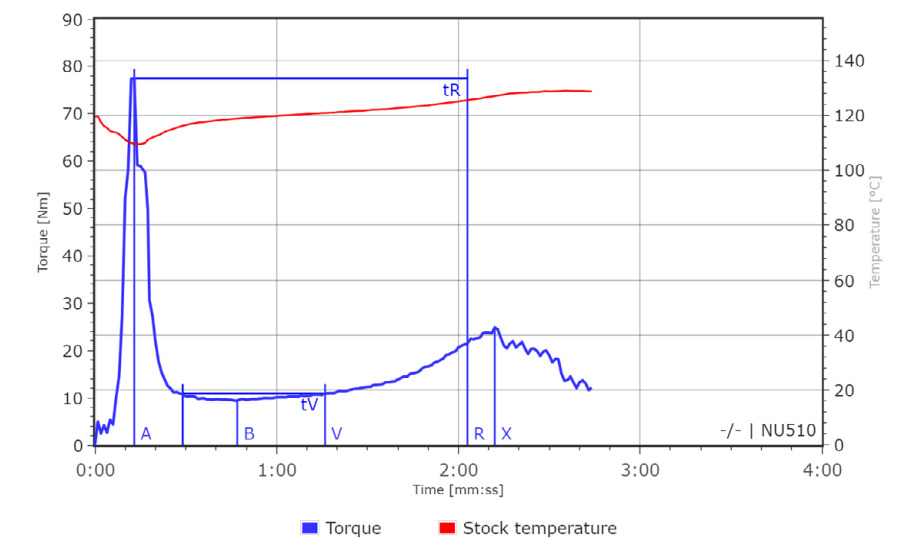

Extend Your Testing Possibilities

Use a wide array of additional accessories to gain further insights into your material:

- Sealing cover for tests under inert gas or for extracting gas and vapor accumulating in the mixer bowl during the test
- Gas flow detector
- Electric conductivity sensor
- Metering pumps/burets for titrating liquids into the mixer
- Heat-resistant glass front plate for observation of the mixing process in a 30/50 EHT measuring mixer (max. temperature 300 °C, glass front plate is not heated)



Increase Reproducibility

Reduce human error and ensure consistent sample handling with our portfolio of loading chutes and pressure rams:

Loading chutes

- Manual loading chutes for quick loading of freeflowing substances like PVC dry blends
- Pneumatic loading chutes for quick, reproducible loading of free-flowing substances, stripes, etc.

Pressure rams

- For loading materials that are sensitive to heat and/or pressure
- For loading bulky materials (e.g. elastomer stripes)
- With bore for titrating liquids into the closed mixing chamber

	Pneumatic loading chutes		
	For series 30 mixers	For series 50 mixers	For series 350 mix
Piston cross section	↓ 12 mm x 23 mm	↓ 12 mm x 45 mm	↓ 20 mm x 79 mm
Piston stroke	200 mm	200 mm	200 mm
Piston force at 5 bars (approx.)	330 N	330 N	1,600 N
Max. operating pressure	8 bar	8 bar	8 bar

Modular Flexibility: One Torque Rheometer for Mixing and Extrusion

The modular design of the MetaStation series enables the use of additional processing and measuring attachments. The mixing devices connected to the torque rheometer MetaStation 4, MetaStation 8 or MetaStation 16 can be replaced by a measuring single-screw or a twin-screw extruder attachment.

1

Single-screw extruder

- Processing of finished compounds and recipes without the need for mixing
- Measurement of speed, torque and temperature during the mixing process
- For applications with increased pressure requirements and the need for torque measurement during processing or testing
- Continuous production of test specimens in the form of strands, tapes, tubes and films
- Performing continuous viscosity measurements and melt characterization on plastic compounds

2

Twin-screw extruder

- Small-scale compounding for R&D purposes
- Lower material demand for expensive and less available materials in the early stages of development
- Avoidance of development and experimental testing on large production machines
- Small scale sample preparation for subsequent investigations
- Processing of a wide range of materials, including polymers, additives, fillers, and reactive substances containing several components mixed together

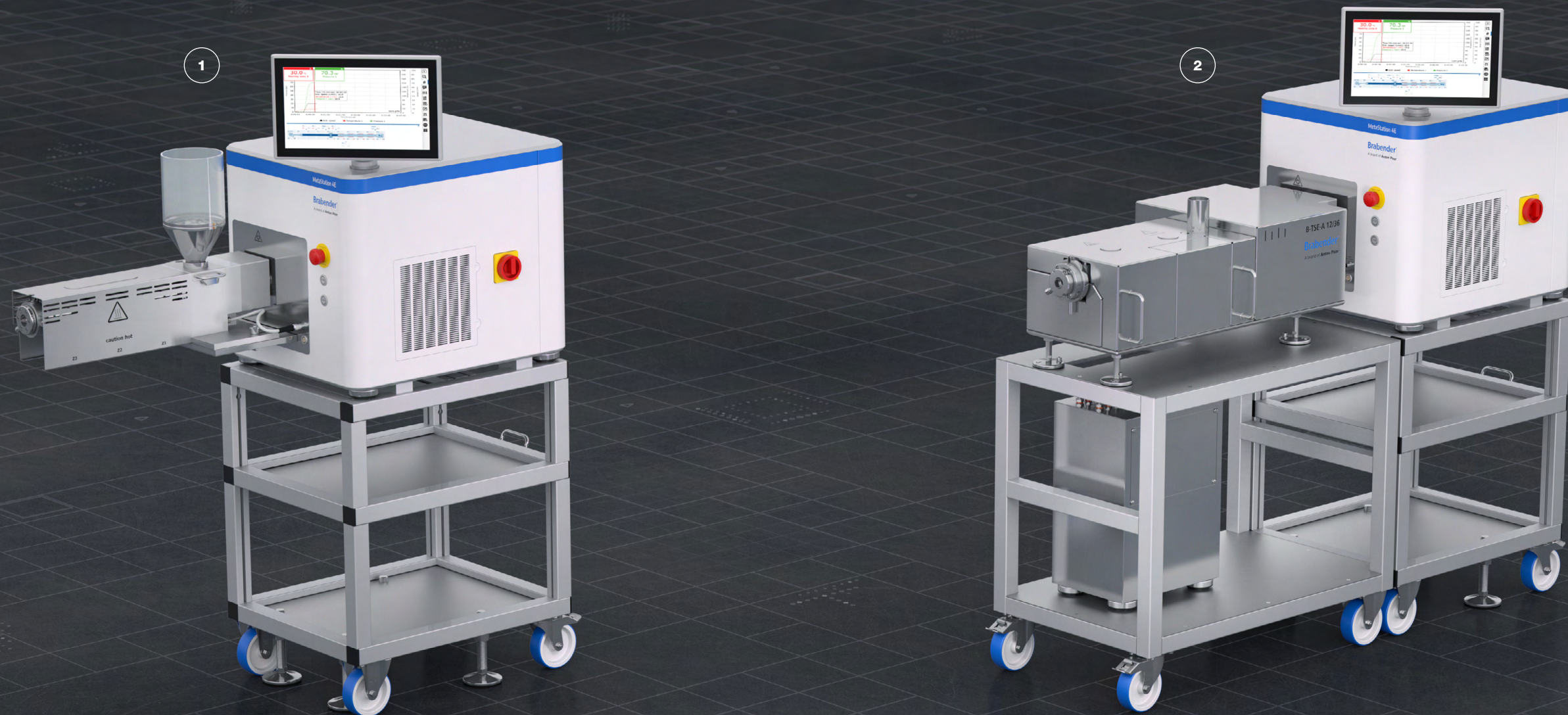

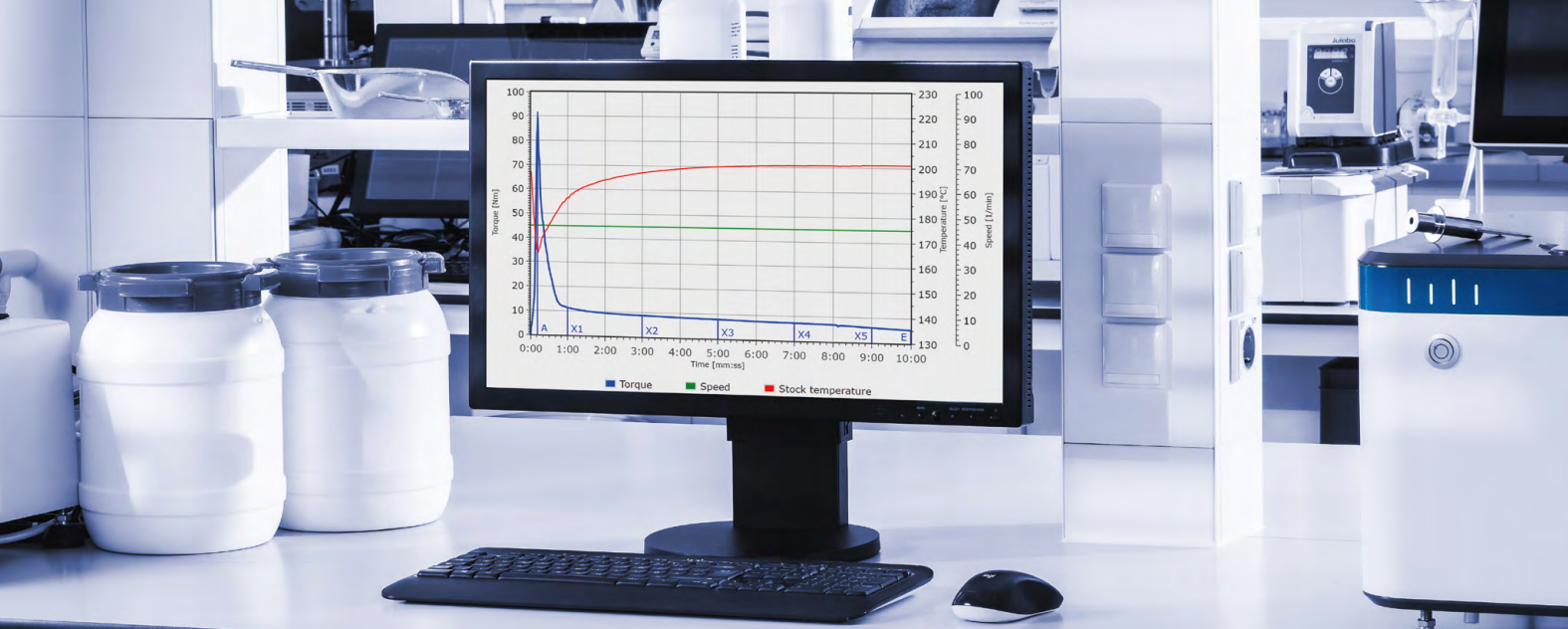

Meet MetaBridge. Meet the Benchmark.

The MetaBridge operating software enables access to your measurement data from any device or location. Export and share data seamlessly with colleagues or third-party systems like LIMS, ERP, or via email. Adhere to your preferred ASTM standard with just a click and transition effortlessly between mixing and extrusion applications.

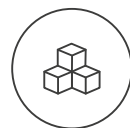

MetaBridge Connect

- Easy access to your measurement data via a web browser within the company network
- Our customer service team is happy to help you at any time via our built-in feedback and remote maintenance function



Data sharing

- Standard data exports in formats such as Excel, CSV, PDF
- Built-in mailing function for a quick exchange with colleagues and customers
- Support of third-party systems (e.g. LIMS, ERP) via Brabender WebAPI, shared network folders or OPC UA



Reference and correlation

- The Reference Curve feature allows material quality monitoring in real time and automatic feedback on whether specifications have been met
- Compare a multitude of measurements with the Correlations add-on feature to obtain an optimal understanding of your materials

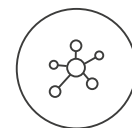

Optimized workflows

- Methods according to well-known ISO and ASTM standards directly usable
- Optimized workflows ensure a smooth process in the laboratory
- Complete flexibility: Adapt the predefined methods and evaluation to your individual requirements at any time

MetaStation 4

MetaStation 8

MetaStation 16

SPECIFICATIONS

	↓	↓	↓
Drive output	4 kW	8 kW	16 kW
Torque and speed	200 Nm, 0.2 min ⁻¹ to 185 min ⁻¹	400 Nm, 0.2 min ⁻¹ to 200 min ⁻¹	400 Nm, 0.2 min ⁻¹ to 400 min ⁻¹ 500 Nm, 0.2 min ⁻¹ to 275 min ⁻¹
Speed deviation	0.2 % through digital feedback		
Integrated temperature control	6 zones	8 zones	
Connectivity	<ul style="list-style-type: none"> - MetaBridge Connect - WebAPI - Labfolder (LIMS) 		
Safety devices	<ul style="list-style-type: none"> - Emergency motor stop button - Non-contact magnetic safety switch on the cover of the measuring system 		
Power supply	3 × 400 V 50/60 Hz + N + PE, 32 A optional: 3 × 220 V 50/60 Hz + PE, 32 A	3 × 400 V 50/60 Hz + N + PE, 63A optional: 3 × 230 V 50/60 Hz + PE, 72 A	
Dimensions (W x H x D)	700 mm x 870 mm x 950 mm	600 mm x 1500 mm x 1370 mm	
Weight (net)	154 kg	311 kg	

Reliable. Compliant. Qualified.

Our well-trained and certified technicians are ready to keep your instrument running smoothly.

FIND OUT MORE

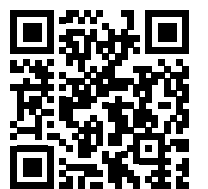

www.anton-paar.com/service



Maximum uptime



Warranty program



Short response times



A global service network

