



# Powered bin trolley

---

## Operating Manual

---

## **Powered Bin Trolley Operating Manual—OM0029E/1**

This manual contains important safety, installation and operating instructions for this unit. Read this manual thoroughly and completely, and retain for future reference. This unit can cause serious injury to personnel or damage to property if used incorrectly, therefore do not use this machine for any other purpose apart from its intended use. Using this unit incorrectly may void warranty.

Any damage audible or visible to this unit should be addressed at the time of discovery. Electrodrive Pty Ltd can provide parts and service support on request through its service partner company:

### **Serviced Equipment Pty Ltd**

p: 1300 934 471

e: [service@fallshaw.com.au](mailto:service@fallshaw.com.au)

Made in Australia by:

### **Electrodrive Pty Ltd**

2A Ayton Street, Sunshine North VIC Australia 3020

p: 1300 934 471 (within Australia)

p: +61 (03) 9300 8521 (International)

e: [sales@electrodrive.com.au](mailto:sales@electrodrive.com.au)

w: [www.electrodrive.com.au](http://www.electrodrive.com.au)

© Electrodrive

# Contents

<b>Introduction</b> .....	<b>5</b>
Features .....	5
Controls .....	6
<b>Operating instructions</b> .....	<b>6</b>
Controls .....	7
<b>Driving instructions</b> .....	<b>9</b>
Safety check .....	9
Steering.....	9
Charging .....	9
<b>Maintenance</b> .....	<b>10</b>
Batteries.....	10
Motor and transmission.....	10
Brakes.....	10
Motor controller .....	10
Throttle lever .....	10
Fuses .....	10
Self-resetting circuit breaker.....	10
<b>Warranty</b> .....	<b>11</b>
Unauthorised maintenance.....	11
Misuse .....	11
General wear items not covered under warranty.....	11
<b>Appendix 1: Machine rating conditions</b> .....	<b>12</b>
<b>Appendix 2: Fault codes</b> .....	<b>13</b>
<b>Appendix 3: Charging procedures for SLA batteries</b> .....	<b>14</b>
Charging setup .....	14

---

During charging .....	14
Charger manual .....	14
<b>Appendix 4: Spare parts list.....</b>	<b>15</b>
<b>Appendix 5: Wiring diagram .....</b>	<b>16</b>
<b>Service log .....</b>	<b>17</b>

# Introduction

## Move multiple wheels bins with the Powered Bin Trolley.

The Powered Bin Trolley can move up to three 240-litre wheelie bins, weighing up to 400 kg over a flat surface. Productivity is greatly increased, and back or shoulder strain is eliminated.

Features:

- The powered drive wheel can carry loads over ramps up to 1:12 gradient.
- Smart design with easy turning action.
- Tiller control keeps you in front of load.

## Features

- Rated to tow up to 400 kg.
- 24 Volt DC power.
- Variable speed drive unit.
- Electro-magnetic park brake.
- Travel speed—up to 5 kph.
- Robust steel chassis.
- Tiller handle steering that folds up to reduce space when not in use.
- Programmable motor controller.
- Automatic charger.

# Operating instructions



## Controls

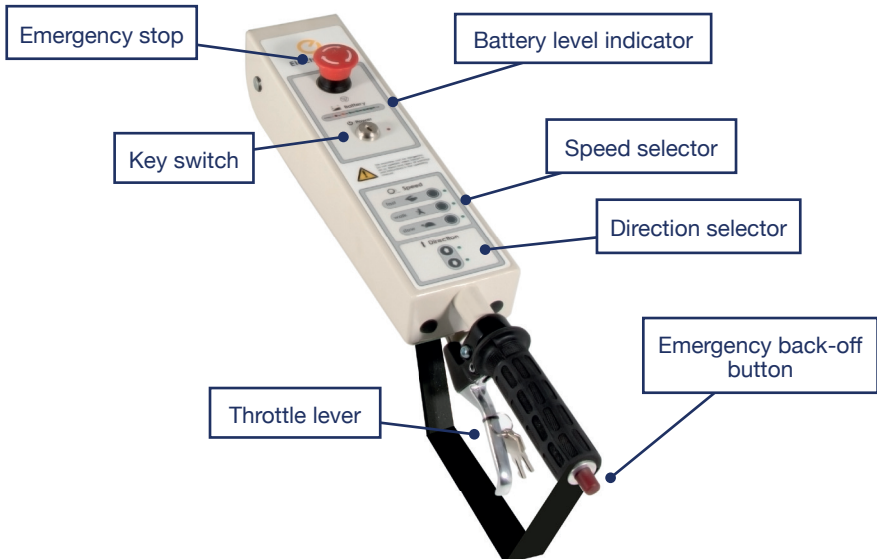

## Controls

### Key switch

The key switch must be turned clockwise to switch the unit on. When ON, the LED status indicator will be illuminated. If a fault occurs with the electronics, this LED light will flash an error code (refer to Appendix 2). It is important to note that the unit should be switched off and the key removed, whenever it is not in use. This eliminates the risk of unauthorised movement and also prevents an unnecessary use of battery power.

### Emergency stop and back-off button

The controls have two emergency buttons.

1. Emergency stop button—in an emergency, push this button to stop the unit. To release, slightly twist the button and it will pop back up.
2. Emergency back-off button—when pressed, the unit will travel backwards until released, to avoid pinning the operator against an obstacle.



**Only use the emergency buttons in an emergency.**

### Direction selector

This determines the direction of travel. Push the button corresponding to the desired travel direction (forward/reverse).

### Throttle lever

This lever provides variable speed control from zero up to 100% of the governed speed. Releasing the lever stops the unit.

### Speed selector

The speed selector will always start in the SLOW position. Select a speed that you are comfortable using. The speed can be changed whilst driving. It is advisable that you operate this unit at a slow speed when entering a confined area.

### Battery level indicator

The battery level indicator indicates the amount of charge left in the batteries. When it appears to be running low, return the unit to the closest charging station to charge the batteries. Being aware of the level of charge of the batteries will eliminate the possibility of running low on power whilst away from the charging station. Red light only indicates no usable battery power remaining.

### Horn (where fitted)

Push to sound the horn, release to turn off.

---

### **Charger socket**

The charger socket is located on the tiller post.

### **Brakes**

When the speed control lever is released, the unit is slowed electrically by dynamic braking until the machine and load comes to a complete stop.

### **Capacity**

Refer to the serial plate for the unit's safe working load, located on the body adjacent to the tiller post.



# Driving instructions

## Safety check

Before using the Powered Bin Trolley the operator should complete the following check:

1. The battery charger is not connected.
2. The direction selector works.
3. The emergency stop button is released.
4. The brakes operate correctly when the throttle lever is released.
5. The battery indicator shows adequate charge.
6. There is no visible damage to the unit.

## Steering

The tiller arm provides easy steering. The Powered Bin Trolley can be manoeuvred through tight areas.



**It is STRONGLY RECOMMENDED that the operator lead the Powered Bin Trolley, rather than “pushing” the Powered Bin Trolley.** This will ensure that the operator has a safe unobstructed view ahead. This will also make the Powered Bin Trolley easy to manoeuvre.

## Charging

Ensure regular recharging of batteries (charging overnight after a day’s usage is recommended). Irregular charging may cause the batteries to prematurely fail.

Leaving a machine in storage without charge for periods greater than a month can also lead to premature battery failure. This is not covered under warranty.

For detailed charging procedures refer to Appendix 1.



**Only use the battery charger supplied with this Powered Bin Trolley.**

The automatic features of the supplied charger ensures that the sealed gel batteries are not overcharged, and only a minimum amount of gas, if any at all, are expelled during charging.

---

# Maintenance

## Batteries

If this unit is not being used for an extended period of time, it should be connected to the battery charger to check the battery level on a regular basis, and placed on charge overnight if required. This will ensure the batteries are kept in good condition.

The batteries are sealed and maintenance free. DO NOT attempt to open these batteries. If the unit is not charged as above, the batteries may be exhausted and have dropped below the charging threshold of the battery charger. The supplied charger cannot begin to charge the batteries unless they have a small amount of charge. If this occurs, contact Electrodrive or your local service agent.

A sign that the batteries need replacing is when they no longer hold charge.

## Motor and transmission

The motor is a sealed unit and does not require regular maintenance.

## Brakes

The dynamic braking system does not require regular maintenance.

## Motor controller

This unit is not serviceable. Any difficulties experienced with speed control should be referred to Electrodrive.

## Throttle lever

The throttle lever and cable do not require maintenance. Should the lever or cable suffer damage they should be replaced. If the handle loosens with wear, the hinge nut can be gently tightened. However, first confirm that the lever is in the correct position as it may need to be reset. (Test by squeezing the lever slightly. The Powered Bin Trolley should slowly move, release and the Powered Bin Trolley should completely stop).

## Fuses

The control circuit is protected against inadvertent current over-loads. This fuse is located adjacent to the controller under the top cover.

## Self-resetting circuit breaker

This Powered Bin Trolley is fitted with a self resetting circuit breaker in case of momentary over-load. This circuit breaker can be found beneath the top cover on the main electrical control panel. If the unit repeatedly over-loads, test the machine, as the motor may be damaged, and continued use could damage the unit further.

## Warranty

Electrodrive Pty Ltd warrants that this product is free from defects in materials and workmanship for a period of twelve months from the date of dispatch from the Electrodrive plant.

If a defect is reported, Electrodrive will repair or replace the defective part, at its own discretion. This warranty does not apply if this unit has been misused, damaged, or modified in any way.

Please be aware that modifications and misuse will void your warranty. The following activities (including, but not limited to) are examples of these:

### Unauthorised maintenance

- The machine is re-wired by an unauthorized service agent.
- The motor controller is re-programmed by an unauthorized service agent.
- There are modifications to the body or frame of the machine.
- Use of non-specified parts.
- The machine is serviced by an unauthorized service agent.

### Misuse

- Overloading the unit either during towing or lifting.
- Carrying people or other foreign objects.
- Exposed to rain or other precipitation, unless weatherproof option is installed.
- Using the emergency back-off system to change direction regularly.
- Exposed to a corrosive environment.
- Driven off road—potholes, gravel, etc.
- Driven on slopes with a steeper gradient than 1:12.
- Not being charged adequately.
- Using the emergency stop button as an ON/OFF button.

### General wear items not covered under warranty

- Castors.
- Drive wheels and motor brushes.
- Hand grips.

# Appendix 1: Machine rating conditions

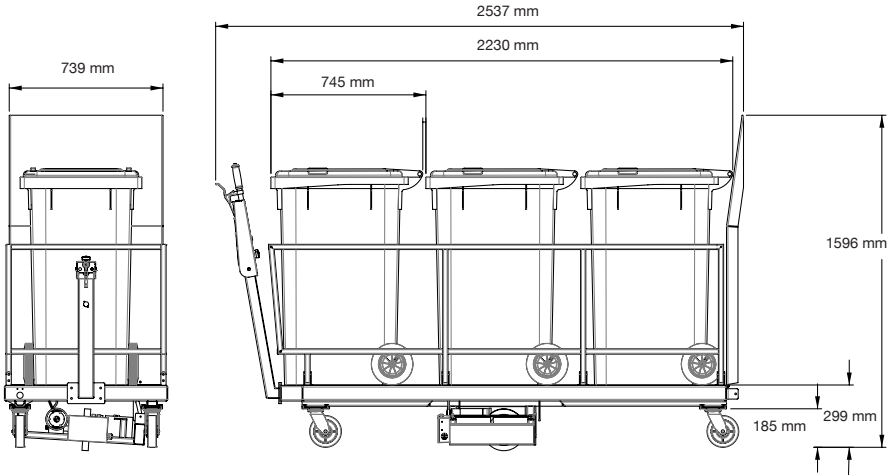

Note: Diagram shown with wheelie bins for illustrative purposes only.

Model	Safe Working Load	Max Load
Powered Bin Trolley	400 kg	400 kg











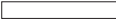











The Powered Bin Trolley has been designed to move the rated weight capacity on a level firm surface. Variations in the working environment may impede the performance of this unit. Such parameters include (but are not limited to) the following:

- Ramps and sloped surfaces
- Soft surfaces (for example carpet)
- Slippery surfaces (gravel, water, oil on the ground, etc)



**It is important that the Powered Bin Trolley IS NOT to be operated outside of the recommended conditions.**

## Appendix 2: Fault codes

		LED codes	Explanation
	LED off		No power or defective controller.
	Solid on		Controller operational; No faults.
1, 1		Thermal cutback fault.	
1, 2		Throttle fault.	
1, 3		Speed limit pot fault.	
1, 4		Undervoltage fault.	
1, 5		Overvoltage fault.	
2, 1		Main contactor drive 'off' fault.	
2, 3		Main contactor fault.	
2, 4		Main contactor drive 'on' fault.	
 3, 1		HPD fault present for > 10 seconds.	
3, 2		Brake 'on' fault.	
3, 3		Precharge fault.	
3, 4		Brake 'off' fault.	
3, 5		HPD (high pedal disable) fault.	
 4, 1		Current sense fault.	
 4, 2		Motor voltage fault (hardware failsafe).	
 † 4, 3		EEPROM fault.	
 4, 4		Power section fault.	

 = Must cycle keyswitch to clear.

† = Must use programmer to clear, as follows: Select 'parameters menu'; alter data vaule of any parameter; cycle keyswitch.

Note: Only one fault is indicated at a time, and faults are not queued up.

---

## Appendix 3: Charging procedures for SLA batteries

- Always charge batteries when work is complete and the equipment is not required for use.
- Opportunity charging is NOT recommended. This can also shorten battery life.
- Never leave batteries in a discharged state as this will shorten the batteries life.
- For maximum battery life, a battery must be recharged to 100% capacity. Recharging less than 100% may result in premature battery failure. Batteries are not covered under warranty if they are not recharged properly.
- If batteries are disconnected from the machine and not used for lengthy periods of time, it is recommended to give them a maintenance charge once every two months.

### Charging setup

- Ensure you have the correct charger for the batteries. The correct voltage and current is important to ensure the full life of the batteries.
- Check all connections are tight and in good condition.
- The green charger LED will illuminate to confirm charging is in progress.
- If charger lights do not come on, call your service technician.
- When charger is plugged in, drive function of machine is automatically inhibited.

### During charging

- Ensure there is enough airflow to help keep the batteries as cool as possible.
- If the batteries are swollen turn off immediately and call your service technician.
- Always leave batteries on charge until the charge is COMPLETE. This is indicated when charger LED turns off.

### Charger manual

Please read BA1105—Battery Charger Operating Manual for more information.

## Appendix 4: Spare parts list

Part	Description	Part	Description
EDBATGEL33AH	Battery—12V 33 Ah	EDGM2051	Tiller pot spring
EDBA1105	Charger—24V 7 Amp	EDGM2150	Throttle cable
EDCL1052	Tiller handle membrane loom	EDGM2170	Throttle lever
EDCL1130	Loom—charger with socket	EDGM2210	Tiller pin—zinc plated
EDEL1041	Battery leads blue/white	OBQ150/HZP	Castor—150 mm
EDEL1100	Blanking plug—13mm	EDTX1010	Transaxle—V24 250W 85 RPM
EDEL1910	Circuit breaker—40 Amp	EDWH1090	Drive wheel
EDEL2110	Motor controller—Curtis 1228	EDWP1049	Tiller handle—complete
EDEL2339	Emergency reverse system	EDWP1875	Tiller post
EDEL2380	Emergency stop button		
EDEL2450	Fuse 1 Amp (charger) (3AG)		
EDEL2470	Fuse 10 Amp (control) (3AG)		
EDEL2500	Fuse holder panel mount		
EDEL2620	Horn button (optional)		
EDEL2630	Horn (optional)		
EDEL2720	Key switch with key		
EDEL2775	Membrane key pad		
EDEL3010	Potentiometer—5k (internal)		
EDGM1810	Handgrip 7/8" x 5"—tiller		
EDGM2040	Spring—tiller handle position		

# Appendix 5: Wiring diagram

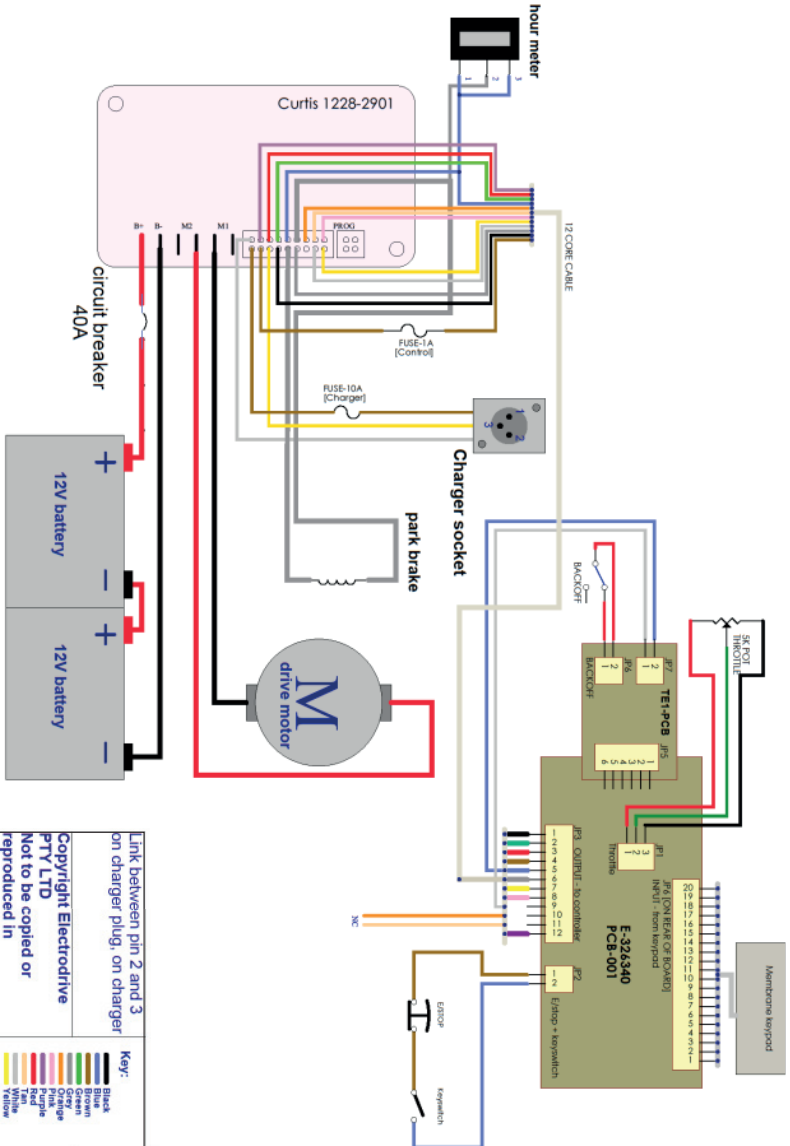

Link between pin 2 and 3 on charger plug; on charger

Copyright Electrodrive PTY LTD  
Not to be copied or reproduced in any way without written permission

Key:  
 Black  
 Brown  
 Green  
 Orange  
 Purple  
 Red  
 Yellow  
 White  
 optional feature

Size	Number	Revision	POWERED BIN TROLLEY
B	M080	A	



# Service log

## Service recommendations

To ensure this equipment is kept in a safe and reliable condition, it is important to follow a preventative maintenance program. Maintain a log of the service work on the cards below, and always use an approved Electrodrive service agent to conduct the works. Approved service personnel will be provided with all necessary documents and components in service repair, including but not limited to, circuit diagrams, component part lists, descriptions, service checklists and spare parts.

## 6 month service

Date of service		Service agent	
Machine serial number			
Summary of works			
Next service due			

---

## 12 month service

Date of service		Service agent	
Machine serial number			
Summary of works			
Next service due			

## 18 month service

Date of service		Service agent	
Machine serial number			
Summary of works			
Next service due			

**24 month service**

Date of service		Service agent	
Machine serial number			
Summary of works			
Next service due			

**30 month service**

Date of service		Service agent	
Machine serial number			
Summary of works			
Next service due			

---

### 36 month service

Date of service		Service agent	
Machine serial number			
Summary of works			
Next service due			

### 42 month service

Date of service		Service agent	
Machine serial number			
Summary of works			
Next service due			

**48 month service**

Date of service		Service agent	
Machine serial number			
Summary of works			
Next service due			

**54 month service**

Date of service		Service agent	
Machine serial number			
Summary of works			
Next service due			

---

## 60 month service

Date of service		Service agent	
Machine serial number			
Summary of works			
Next service due			



---

**Mobility solutions to help you push, pull & lift with ease.**

[www.electrodrive.com.au](http://www.electrodrive.com.au)