

# PRI MIUS

WATERJET CUTTING  
SYSTEMS



# READY TO CONQUER NEW MARKETS



## THE MARKET DEMANDS

a simple technology that matches the continuous **evolution of the materials** and the application requirements and grants **performance and control over production costs**.

## BIESSE ANSWERS

with a range of highly customized **technological solutions** designed for dynamic companies that need to achieve further optimization in cutting. **Primus** is the new waterjet system designed to meet the needs of companies seeking maximum versatility.

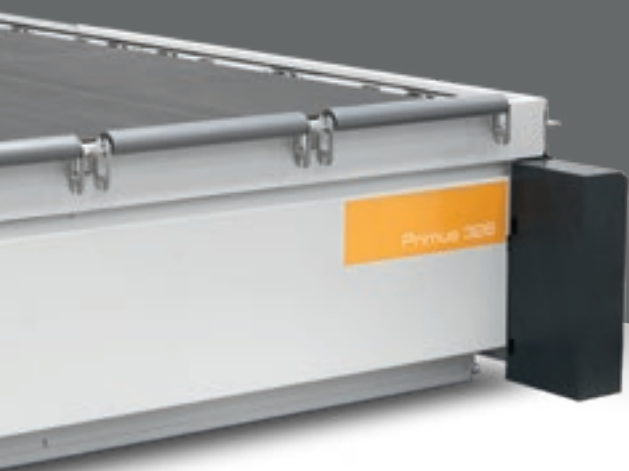

# PRIMUS

- ✓ IDEAL FOR CUTTING ANY TYPE OF MATERIAL AND FOR PERFORMING ALL COMPLEX SHAPING OPERATIONS
- ✓ HIGH QUALITY AND PRECISION AND OPTIMUM CUT FINISH
- ✓ EXCELLENT PERFORMANCE AND OPTIMISATION OF CUTTING COSTS
- ✓ SET-UP TIMES REDUCED TO ZERO THANKS TO THE SIMPLICITY OF THE FIXING AND SETTING SYSTEMS
- ✓ ADVANCED TECHNOLOGY
- ✓ WIDE RANGE OF RETROFITTABLE OPTIONAL DEVICES

# IDEAL FOR CUTTING ANY TYPE OF MATERIAL



Ease of use and the ability to cut all types of materials combined with high quality and precision and optimal cut finishes make the Primus range suitable for a wide range of users.

The Primus 402 can be configured with either a single or double cutting head.



A technology that looks to the future. Primus can easily cut composites and plastics materials, non-metallic alloys, titanium, aluminum, metal.



With special applications for variable Z-axis machining operations, this system allows three-dimensional materials to be processed using dedicated software.

The **Primus 202** can be configured with either a single or double cutting head.



The cutting process makes use of Waterjet technology, which machines materials by means of a high-speed jet of water and abrasive (where necessary), with pressures that can reach 400 MPa.

# PERFORMANCE AND PRODUCTIVITY

Primus can be configured with one or more independent\* cutting heads to meet the customer's production needs.

Maximum productivity with an energy-saving dual 60 hp pump, for a total capacity of 9.2 l/min. If necessary, the pumps work simultaneously. Alternatively, one of the two is automatically deactivated to optimise energy efficiency and reduce component wear



Each cutting head is fitted with an independent, automatic abrasive management system to constantly ensure the right amount for the machining operation in hand.



Work can be done on 3 or 5 axes, which allows for 45 degree cuts or 0 to +/-60° angled cuts to be performed, as well as chamfering or countersinking operations.

\* not available for the Primus 184.

The software automatically adapts the number of cutting heads to suit the panels being created, to guarantee maximum productivity at all times without losing sight of flexibility requirements (one cutting head for pieces that are different from each other, or two for cutting several identical pieces simultaneously).



## **MACHINING CAN ALSO BE PERFORMED IN DOUBLE STATION CONFIGURATION, DIVIDING THE ENTIRE WORKING AREA INTO TWO ZONES.**

The machine continues cutting in one of the two zones, while the operator can safely unload and load pieces in the other.



# WIDE RANGE OF WORK TABLE CONFIGURATIONS

Support surfaces are available for special materials and applications, to minimise the reverberation of the jet of water on the material being machined and to facilitate the drainage of water and small machining residues.

PRIMUS 322

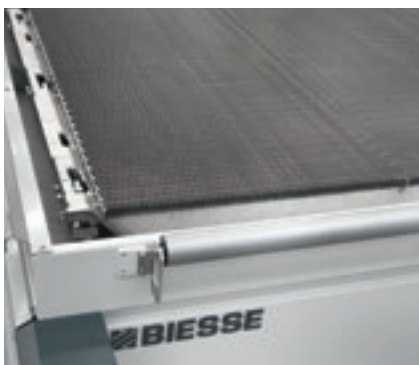
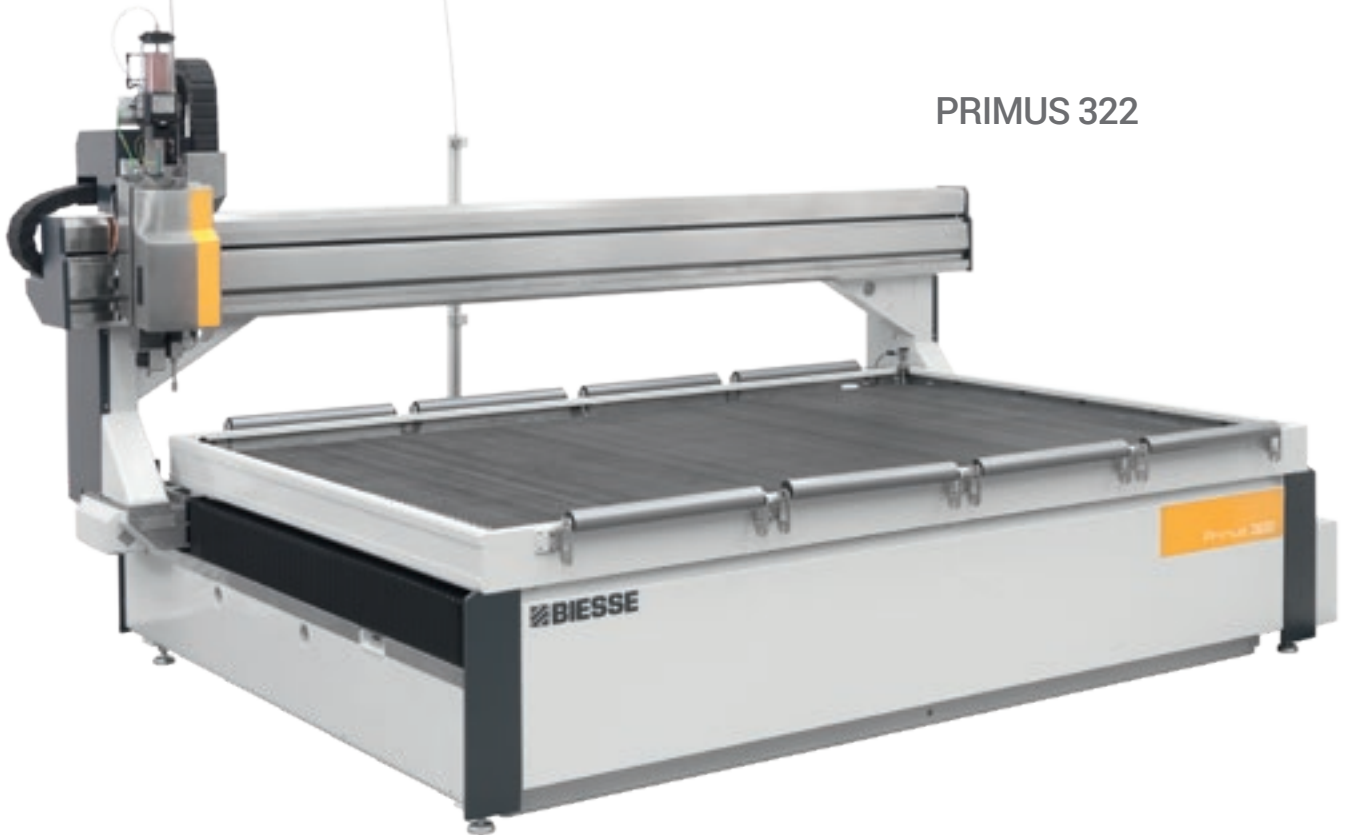

Stainless steel table for pure waterjet applications.

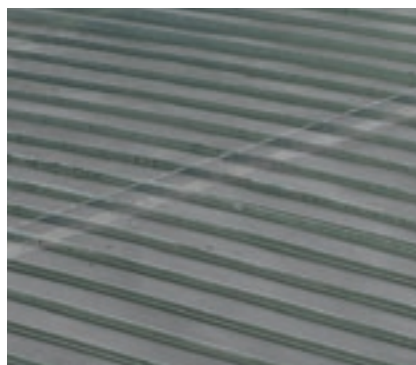

Table with steel blade for abrasive jet applications.



Locking/tooling systems for round or square pipes.



# EASY WORK TABLE MAINTENANCE



PRIMUS 326

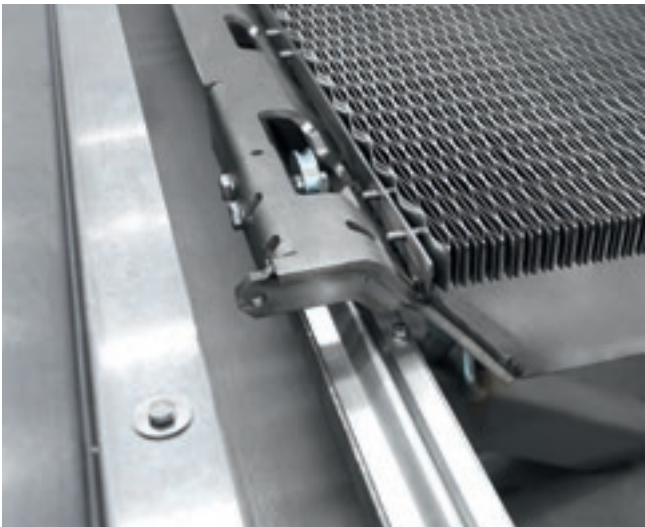

Sliding tables  
to facilitate  
tank maintenance tasks.

# A SOLUTION FOR EVERY NEED

Maximum scope for customisation in order to respond to market demands for a solution that adapts to materials as they evolve, as well as to a host of very varied application requirements.

## PRIMUS 202

For machining small formats 2000 x 2000 mm.  
With the same characteristics as the other machines in the range, including the possibility of twin head configuration.



## PRIMUS 402

The Primus 402 is the ideal solution for machining all materials with a size of 4000 x 2000 mm.

## PRIMUS 184

Ideal solution for all workshops with limited space.  
The Primus 184 is designed as a plug-and-play system that enables production to begin straight away.  
It stands out for its compact overall dimensions - the electrical cabinet is integrated into the console cabin, while the optional abrasive removal system is incorporated into the structure of the machine itself.



## SPECIAL SOLUTIONS FOR SPECIFIC PRODUCTION NEEDS

### PRIMUS 402 WITH DUAL TANK

Primus 402 with dual tank: ideal for pendulum machining for 4000 x 2000 mm size sheets.



### PRIMUS 3212 WITH DOUBLE BEAM

Two independent machines (3210 x 6000 mm) with single beam for machining up to 12,000 m.



# OPTIMISED CUTTING COSTS

Dynamic control over the abrasive flow and the main cutting parameters ensures cost optimisation without any production compromises: the machine maintains maximum productivity by accurately controlling production costs.

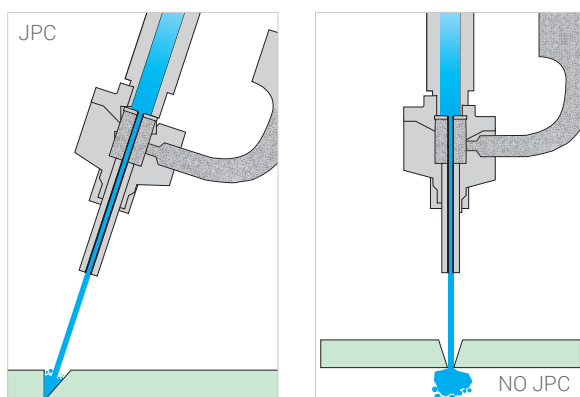

Developed by Biesse, JPC (Jet Performance Control) technology maximises machining efficiency in terms of profile quality and cutting speed.

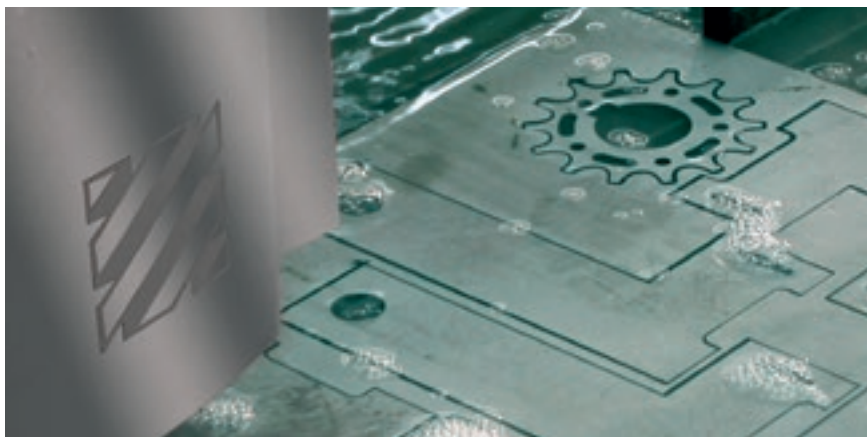

The thickness tracer system automatically adjusts the optimum distance between the cutting head and the piece surface, improving the quality of the cut and guaranteeing the utmost safety during machining operations.

# ZERO SET-UP TIMES

Thanks to the automatic centring check on the 5-axis head, there is a reduction of about 90% in the head centring time following the replacement of cutting head components.



### Maximum accessibility in total safety.

The main advantage of this new solution with opening casing is that it enables customers to quickly inspect the head unit and perform maintenance operations, with no need to remove the casing.

Laser pointer for defining the positioning of the sheet on the work table.

The laser pointer can be used for manual template learning.



# TECH NOLOGY



## C-AXIS WITH ENDLESS ROTATION

**Maximum programming flexibility thanks to the free movement of the cutting head.**

The 5-axis cutting head is equipped with a patented endless rotation C-axis system, which allows sloping cut profiles ( $\pm 60^\circ$ ) to be produced with the best possible quality even when working with complex shapes, with no limitations. This system eliminates the errors often found in traditional systems resulting from the rotating axis reverse clearance, as well as guaranteeing a constant supply of abrasive material.

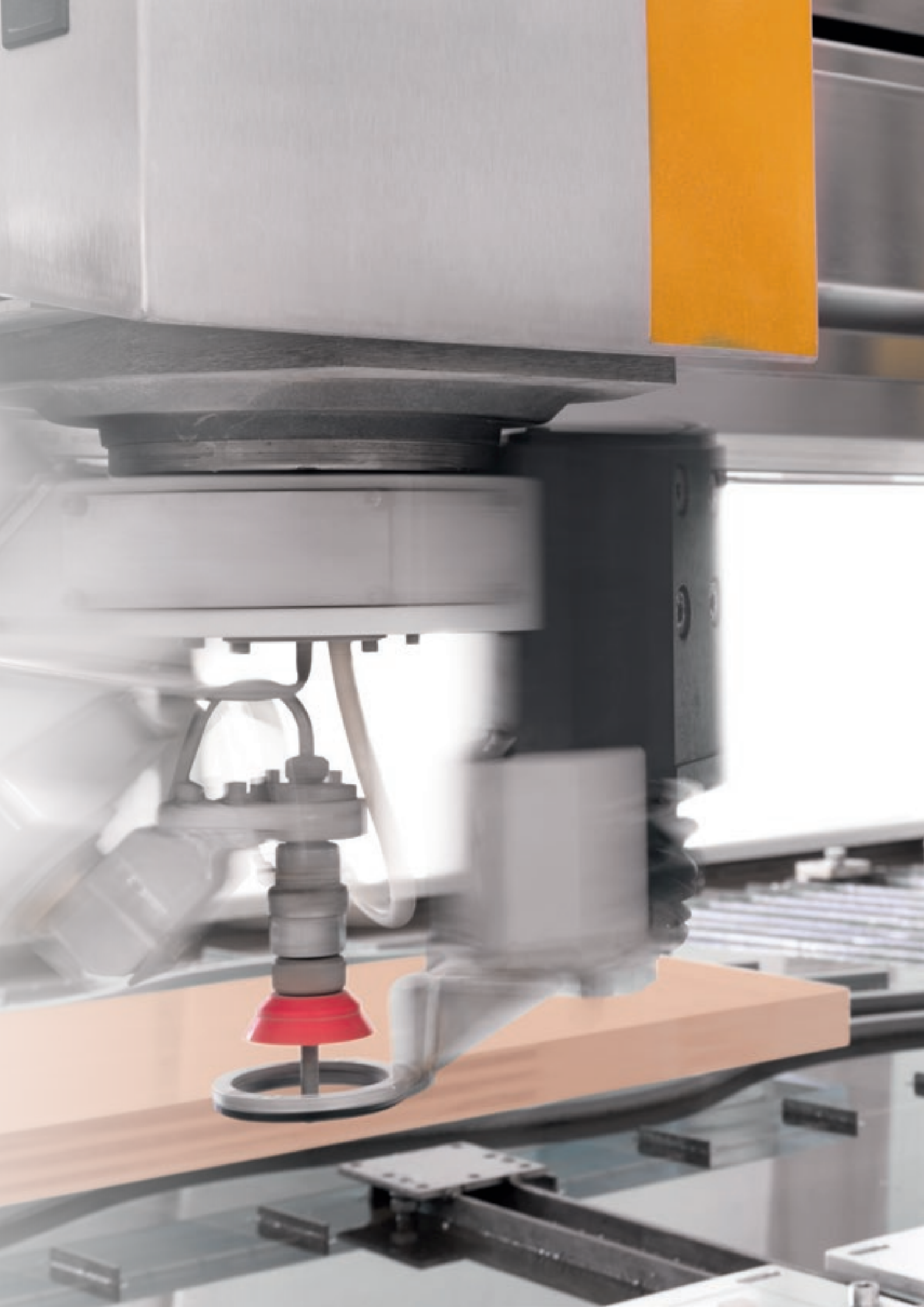

# EASY TO LOAD AND UNLOAD FOR THE OPERATOR

A compact and ergonomic solution with maximum accessibility on 3 sides, enabling material to be loaded and unloaded with ease.



Option to fit front and rear rollers to facilitate material loading and unloading.

## MACHINING CAN ALSO BE PERFORMED IN DOUBLE STATION CONFIGURATION, DIVIDING THE ENTIRE WORKING AREA INTO TWO ZONES.

In one of these two zones, the machine continues to cut, while the operator can safely unload and load pieces in the other area in the meantime.

The barrier that divides the table into two can be easily removed, so that the operator always has the option of using the maximum working area, operating in a single zone when necessary.





# MAXIMUM EASE OF USE

The quality of the cut and the main machining parameters (such as the capacity of the abrasive material) are controlled via the software, and can be altered at any time - even while the piece is already being machined. This means the machine operator has full control over production costs.



The hand-held terminal allows the operator to carry out the main machine operations with great ease and safety, as he can move away from the control panel when necessary.



The numerical control is responsible for always maintaining the moving organs perfectly lubricated. The machine is also provided with a oil-remover and dryer device to avoid the abrasive being contaminated by moisture and other impurities present in the circuit of compressed air.



# HIGH EFFICIENCY AND ENERGY SAVINGS

Maximum levels of professional performance thanks to the advanced pump technology system.

A complete range of extra high pressure intensifiers to meet the needs of even the most demanding customer. All the systems are fitted with a high-volume pressure accumulator (2.49 l) to minimise the typical pressure fluctuations and component wear. The proportional valve allows the pressure intensity to be altered to suit the material being machined and the type of cut to be made. Maximum access to all parts subject to wear, to facilitate maintenance and repair operations.

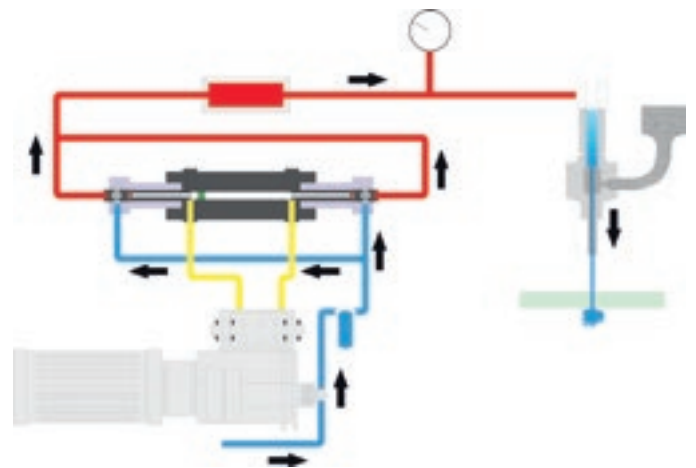

## ECOTRON

The excellent quality/price ratio is the main advantage of this pump model. The pressure is generated by an axial piston pump, which is precisely regulated by a standard proportional valve.



## HYTRON 40.75

The pump is equipped with two air multipliers, regulated by two axial piston pumps which use an electronic control system in order to guarantee an optimal pressure flow. Thanks to the high flow rate it delivers, this type of pump is ideal for customers who work with thicker panels and for those who wish to maintain good working speeds, even when operating with multiple cutting heads.



## SERVOTRON

The pressure is managed via a frequency-regulated servomotor (BFT patented), which enables energy savings of around 24% more than those offered by conventional pumps. This technology also increases the lifespan of the high pressure components (seals, valves) and helps to reduce wear across the entire high pressure system, from the pump to the cutting head.

Less effort, more power. the transmission systems of the future.

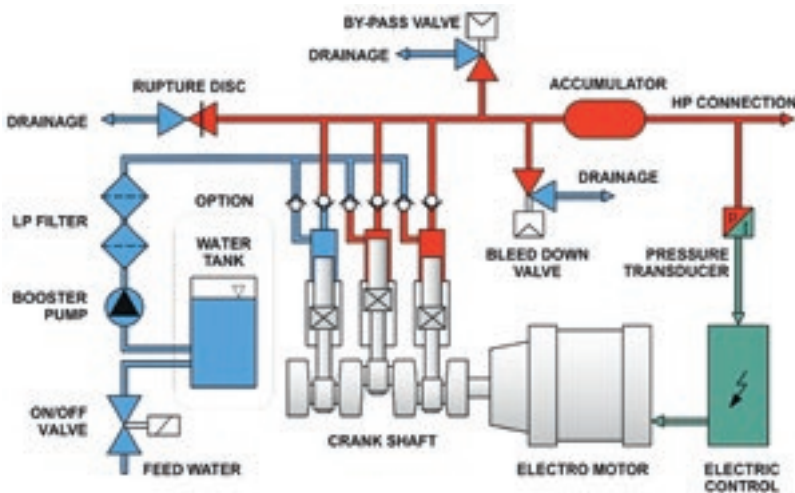

## VECTRON

The pump operates in the 22 kW power class, with a flow rate of up to 3.5 l/min at an operating pressure of 3,800 bar. The three-piston pump is ideal for small businesses, due to its low power consumption; the energy efficiency offered by this pump is around 25 percent higher than that provided by a standard high-pressure pump.

- ▶ New direct-drive high-pressure pump
- ▶ Minimal energy consumption, perfect for small businesses

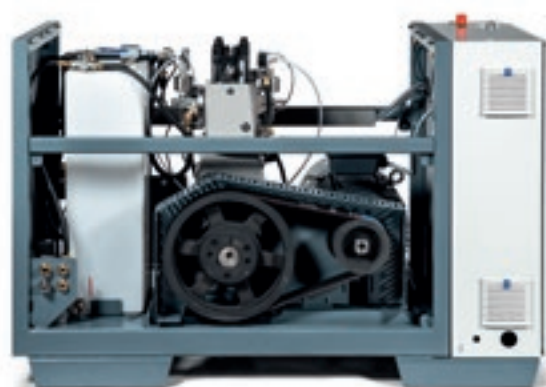

# POWERFUL PERFORMANCE THAT MAKES ALL THE DIFFERENCE



Working with KMT means being able to rely on experience, reliability and an extensive network.



## KMT NEO 50

KMT Waterjet NEO 50 solutions are the embodiment of more than 50 years of experience, and offer hi-tech waterjet cutting results that are simply unprecedented.

Threaded high-pressure cylinders eliminate any misalignment during assembly, keeping downtime to an absolute minimum. The cutting-edge hydraulic tool change delivers seamless changes without delay, with real-time command and control functions - all of which enables reduced maintenance costs and ease of operation.

# PROTECTION AND SAFETY FOR ALL MACHINING OPERATIONS



**The abrasive propulsor allows the operator to load fresh abrasive in the first tank without needing to stop the machine.**

It consists of two parts - one tank with an abrasive load capacity of about 330kg, and another that is pressurised.



**Automatic system for removing used abrasive (including a 1m<sup>3</sup> big-bag holder with control panel, relative PLC and management software), that can be used separately from the machine.**

Thanks to this new solution, the work hours of the abrasive removal system can be programmed in any time band (e.g. during the night, when electricity may cost less). Another advantage concerns the possibility to carry out system maintenance without having to stop the machine.

# PROTECTION AND SAFETY FOR ALL MACHINING OPERATIONS

Intermac has always paid the utmost attention to the health and safety of its customers. The protection of every operator during the use of the machine is of vital importance, preventing any possible distraction or error that could lead to inconvenience or even accidents.

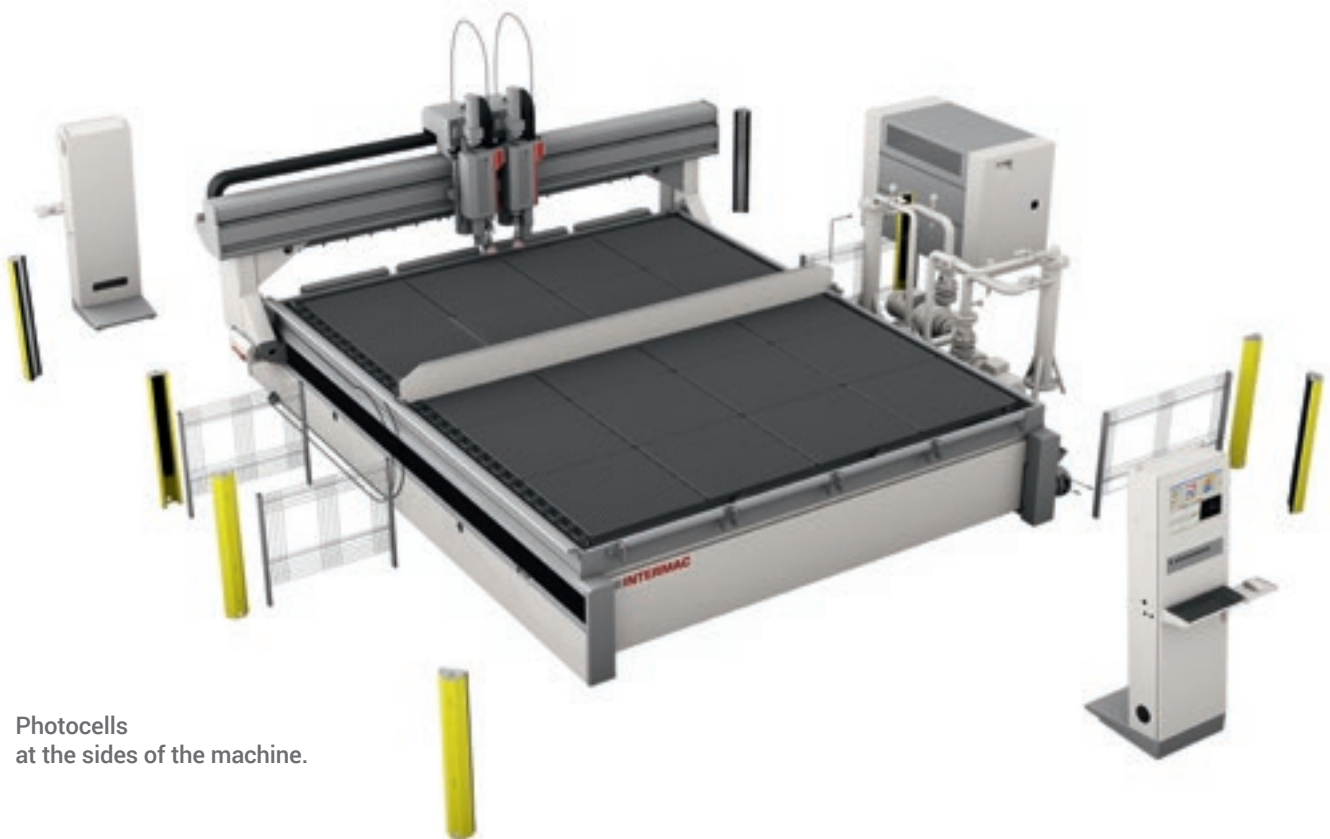

Photocells at the sides of the machine.

Full respect for machinery directives and workplace health and safety regulations is an indispensable condition for obtaining any sort of financing.

# IC: THE EXPERIENCE IN A SINGLE SOFTWARE PACKAGE



IC

**IC IS A HIGHLY RELIABLE AND ROBUST SOFTWARE THAT COMBINES TOP PERFORMANCE WITH EXTREMELY EASY USE.**

- **RENEWED GRAPHIC INTERFACE THAT'S USER-FRIENDLY AND EASY TO PICK UP THANKS TO SELF-LEARNING CONCEPTS, BUT WITHOUT COMPROMISES IN TERMS OF FUNCTIONS AND PROGRAMMING FLEXIBILITY**
- **ROBUST, RELIABLE PLATFORM**
- **ENHANCED CALCULATION POWER THANKS TO THE USE OF THE LATEST DEVELOPMENT TECHNOLOGIES**
  
- **MODERN INTERFACE:** similar to the most modern apps, it can be used with a touch screen.
- **EXTREMELY USER-FRIENDLY:** assisted design in 5 steps. From the drawing to the machine in just a few seconds.
- **TOTAL CONTROL OF THE DESIGN PROCESS, FROM THE DRAWING TO THE FINISHED PIECE.**
- **SOLUTIONS FOR LARGE-SCALE OR ONE-BATCH PRODUCTION:**  
the possibility to manage libraries of models (even parametric).
- **AUTOMATIC NESTING FEATURES IN 4 SIMPLE STEPS:**  
the geometries are automatically recognized, corrected, the pieces prepared and the machinings applied. IC nesting for Primus is able to automatically recognize multiple shapes contained within the same DXF or DWG file.
- **SUPPORT SERVICE ALONGSIDE THE CUSTOMER:**  
IC is equipped with "AIC Log" technology: in the event of problems and/or a need for support, Intermac Service can see the operations that have been carried out, and can quickly intervene

# ALL FUNCTIONS JUST A CLICK AWAY

**EASYJET IS CAD/CAM SOFTWARE SPECIALISED IN THE MACHINING OF METALLIC MATERIALS ON NUMERICAL CONTROL WATERJET MACHINES. WIDELY USED IN THESE SECTORS, IT CAN BE USED TO PERFORM THE MOST COMMON WATERJET MACHINING OPERATIONS. COMPATIBLE WITH THE EASYSTONE PACKAGES ALREADY INSTALLED, IT HAS FLEXIBLE CONFIGURATION TO MEET CUSTOMERS' NEEDS.**

▸ **Simple and intuitive**

It can even be used by individuals who don't have specialised computer skills: all functions are "just a click away".

▸ **Complete**

Manages all aspects of machining operations, guiding the operator from designing to arranging the pieces on the work table, creating workflows, simulating machining, optimising the placing of the pieces on the sheet with automatic Nesting functions and generating machine programs.

▸ **Nesting**

Nesting is used to automatically optimise the placing of the pieces on the sheet by minimising waste and recovering scrap, or manually arranging the pieces using the magnet, alignment, movement and rotation functions. You can handle a list of the pieces to be put into position by importing projects that include machining or drawings in the most widely used formats.

▸ **Ideal for all types of machining**

Can be used to program all 3 and 5 axis waterjet cutting operations with angles of up to 60°.



# EASYJET

**DESIGNED TO PROGRAM WATERJET MACHINING OPERATIONS WITH EASE, IT ENHANCES THE PRIMUS MACHINES' POTENTIAL.**



# TECHNICAL SPECIFICATIONS

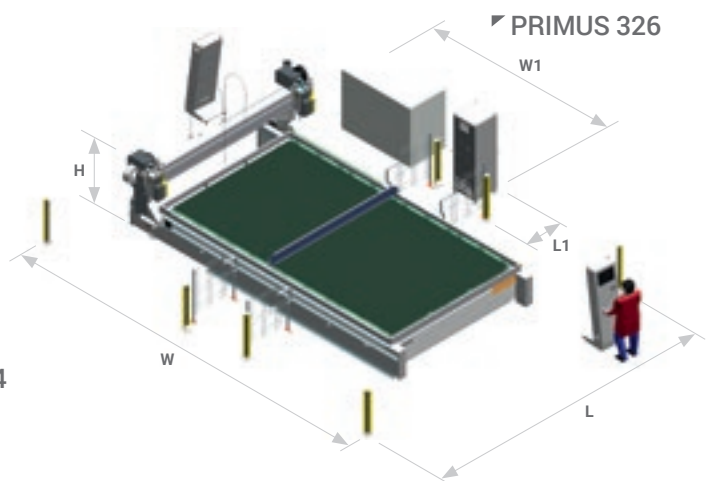
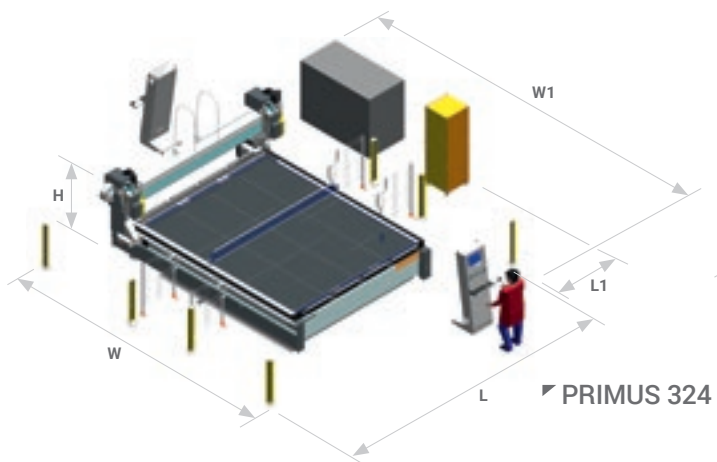
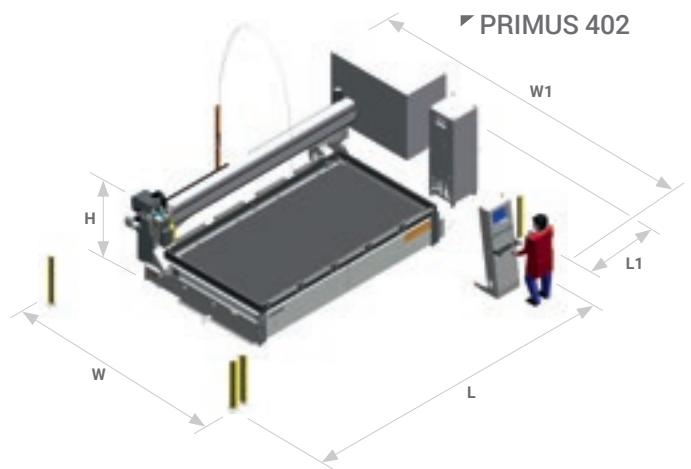
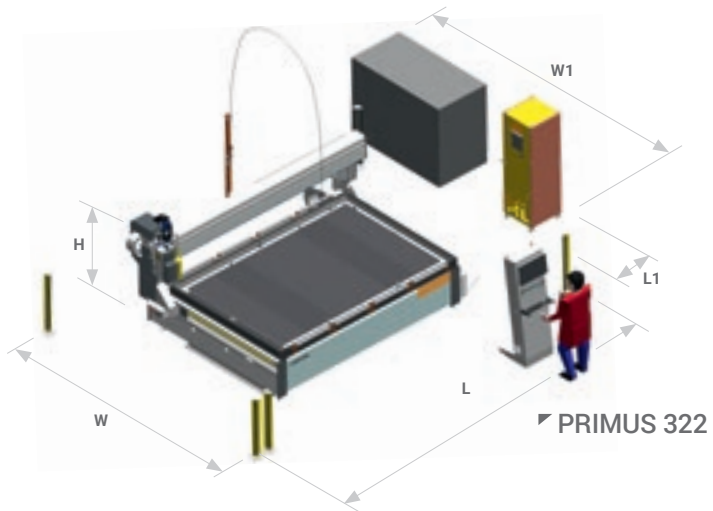
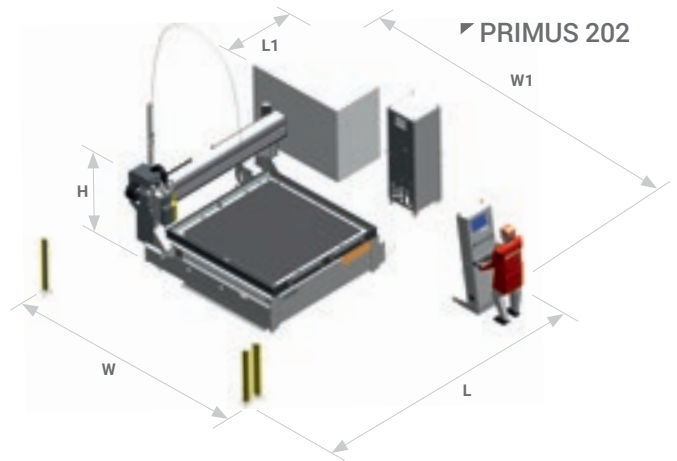
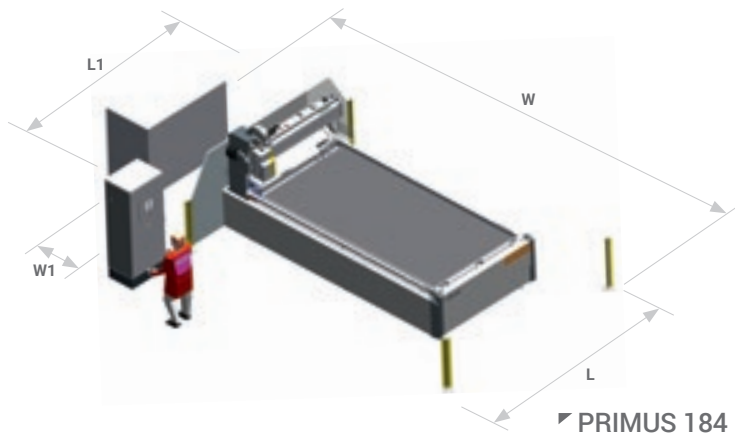

	PRIMUS 184	PRIMUS 202	PRIMUS 322	PRIMUS 402	PRIMUS 324	PRIMUS 326
Working area X-Y (mm)	1860x4000 1700x3800*	2000x2000	3210x2000	4000x2000	3210x4000	3210x6000
Maximum sheet dimensions for loading X-Y (mm)	2010x4300	2080x2250	3300x2250	4100x2250	3300x4300	3300x6300
Z axis stroke	250 (200 with 5-axis head)					
Maximum speed of X-Y axes	45 m/min					
Maximum capacity of the piece support table	1000 Kg/mq					
A-axis	+/-60°					
C-axis (opt.)	Endless					
Minimum centre distance between cutting heads (3 axes)	-	280 mm				
Minimum centre distance between cutting heads (3 + 5 axes)	-	340 mm				
Minimum centre distance between cutting heads (5 axes)	-	500 mm				

\*with 5-axis cutting head

#### UHP PUMP - TECHNICAL DATA

Power pump UHP	22 kW	30 kW	37 kW	45 kW	75 kW
Max. pressure	420 Mpa				
Max. water flow rate	2 l/min (ECO 40.22) 3.5 ll/min (VEC 40.22)	3,2 l/min	3,8 l/min	4,1 l/min	7,8 l/min

OVERALL DIMENSIONS		PRIMUS 184	PRIMUS 202	PRIMUS 322	PRIMUS 402	PRIMUS 324	PRIMUS 326
L	mm	3900	5070	6280	7590	6280	6280
L1	mm	3900	1650	1650	1650	1650	1650
W	mm	6490	4940	4940	4940	7130	9210
W1	mm	800	4940	4940	4940	4940	4940
H max (standard)	mm	3000	5000	5000	5000	3000	3000
H max (optional)	mm	-	3000	3000	3000	-	-

The technical specifications and drawings are non-binding. Some photos may show machines equipped with optional features. Biesse Spa reserves the right to carry out modifications without prior notice.

PRIMUS 184 Weighted sound pressure level A L pA 80 dB. PRIMUS 202/322/324/326/402 Weighted sound pressure level A LpFA 81 dB(A). Superficial weighted noise level A LwA 102 dB (A). Uncertainty of measurement K = 4dB (A).

The measurement was carried out in compliance with UNI EN 1218-4, UNI EN ISO 3746, UNI EN ISO 11202 of 2009 and subsequent modifications (UNI EN ISO 3746:2011). The noise levels shown are emission levels and do not necessarily correspond to safe operation levels. Even though there is a relation between emission levels and exposure levels, this cannot be used reliably to establish whether or not further precautions are necessary. The factors determining the actual noise levels to which the operating personnel are exposed include the length of exposure, the characteristics of the work environment, other emission sources (e.g. the number of machines and machining operations nearby). At any rate, the above information allows the operator to better evaluate dangers and risks.

# SOPHIA

GREATER VALUE FROM MACHINES

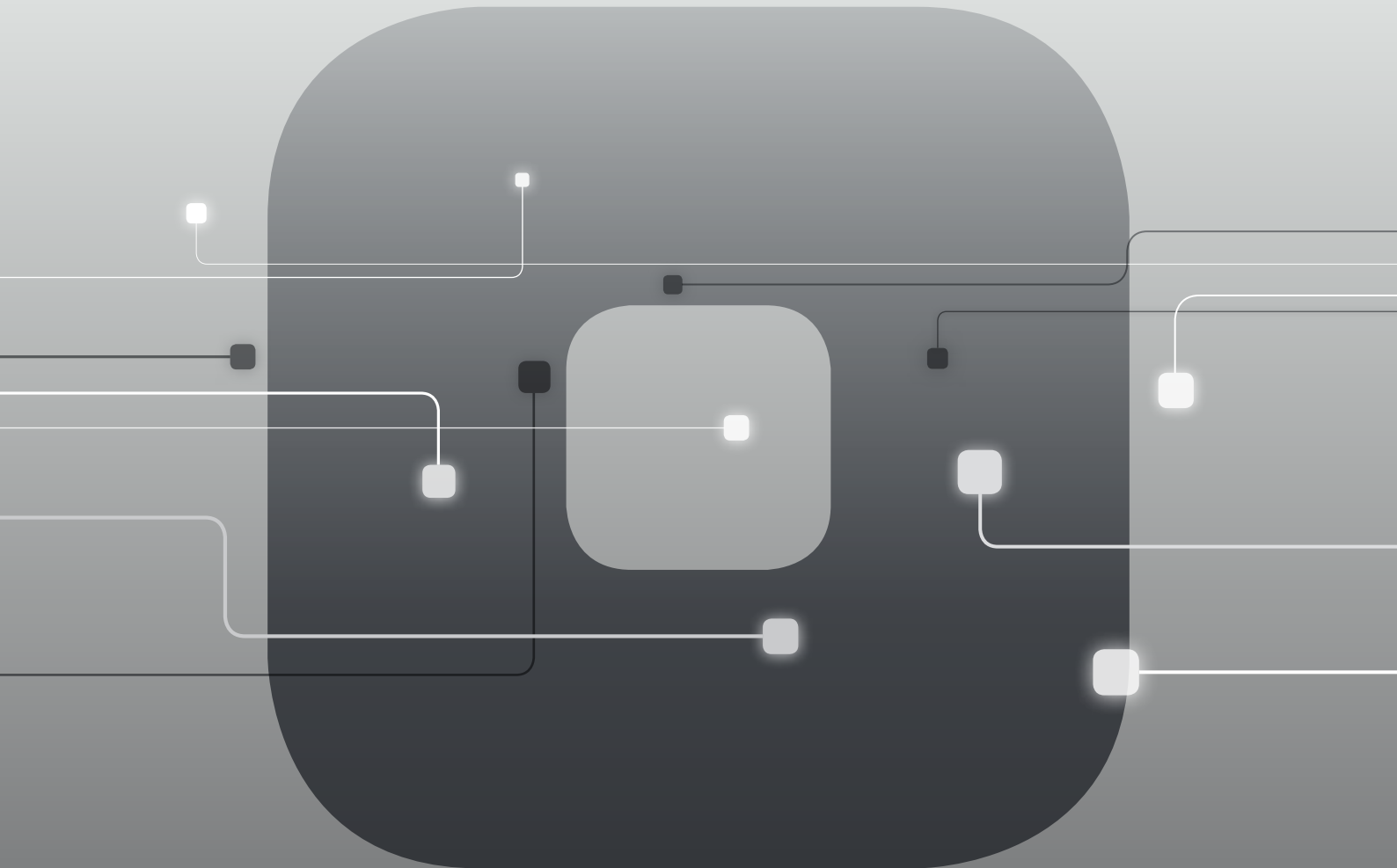

SOPHIA is the IoT platform created by Biesse in collaboration with Accenture which enables its customers to access a wide range of services to streamline and rationalise their work management processes.

It allows alerts and indicators to be sent to the customer in real time, in relation to production, the machines used and the type of process carried out. These are detailed instructions for more efficient use of the machine.

10% CUT IN COSTS

50% REDUCTION  
IN MACHINE DOWNTIME

10% INCREASE  
IN PRODUCTIVITY

80% REDUCTION IN PROBLEM  
DIAGNOSTICS TIME

SOPHIA TAKES THE INTERACTION BETWEEN  
CUSTOMER AND SERVICE TO A HIGHER LEVEL.

**iOT**  
SOPHIA

IoT - SOPHIA provides a comprehensive overview of the specific machine performance features, with remote diagnostics, machine stoppage analysis and fault prevention. The service includes a continuous connection with the control centre, the option of calling for assistance from within the customer app (such calls are managed as priorities), and an inspection visit for diagnostic and performance testing within the warranty period. Through SOPHIA, the customer receives priority technical assistance.

**PARTS**  
SOPHIA

PARTS SOPHIA is the easy new, user-friendly and personalised tool for ordering Biesse spare parts. The portal offers customers, dealers and branches the chance to navigate within a personalised account, consult the constantly updated documentation of the machines purchased, and create a spare parts purchase basket indicating the real time availability in the warehouse and the relative price list. In addition, the progress of the order can be monitored at all times.

 **Biesse**

in collaboration with **accenture**

# CUSTOMER CARE IS WHO WE ARE

**SERVICES** is a new experience for our customers, to offer not just excellent technology but the added value of an increasingly direct connection with the company, the professionals who work there and the experience they embody.



## **ADVANCED DIAGNOSTICS**

Digital channels for remote interaction online 24/7. Always ready to intervene on-site seven days a week.



## **A WORLDWIDE NETWORK**

39 branch offices, over 300 certified agents, retailers in 120 countries, and spare parts warehouses in America, Europe and the Far East.



## **SPARE PARTS AVAILABLE IMMEDIATELY**

Identification, shipping and delivery of spare parts for every need.



## **EVOLVED TRAINING OPPORTUNITIES**

Lots of on-site, online and classroom training modules for personalised growth.



## **VALUABLE SERVICES**

A wide range of services and software packages to help our customers achieve continuous improvements in performance.

## AN EXCELLENT LEVEL OF SERVICE

**+550**

HIGHLY SPECIALISED  
TECHNICIANS AROUND  
THE WORLD, READY TO HELP  
CUSTOMERS WITH EVERY  
NEED

**90%**

OF MACHINE DOWN CASES  
WITH RESPONSE TIME  
UNDER 1 HOUR

**+100**

EXPERTS IN DIRECT  
CONTACT THROUGH  
REMOTE CONNECTIONS  
AND TELESERVICE

**92%**

OF SPARE PARTS ORDERS  
FOR MACHINE DOWNTIME  
PROCESSED WITHIN 24  
HOURS

**+50.000**

ITEMS IN STOCK IN THE  
SPARE PARTS WAREHOUSES

**+5.000**

PREVENTIVE MAINTENANCE  
VISITS

**80%**

OF SUPPORT REQUESTS  
SOLVED ONLINE

**96%**

OF SPARE PARTS ORDERS  
DELIVERED IN FULL ON TIME

**88%**

OF CASES SOLVED WITH  
THE FIRST ON-SITE VISIT

# MADE WITH BIESSSE

## OUT TO CONQUER THE SKIES

Notable experience built up over the years in the aerospace field, optimum component quality, constant attention to the environment: it's thanks to these three strengths that Tecnologie Avanzate is taking off.

A business strategy based on key points that have grown stronger over the course of three generations - that's what has allowed Tecnologie Avanzate, a company in Veroli (Frusinate), to stand out and make a name for itself in the aerospace sector. This family-run firm is led by Sisto

Fini, owner and Sales Director of Tecnologie Avanzate. The company was created from the split of TecnAvan in 2008, after accumulating 20 years' experience, into TecnAvan Interiors and Tecnologie Avanzate, the former specialising in the production and maintenance of components for internal furnishings and special equipment for aeroplanes, the latter in the production and destructive or non-destructive control of aerospace components. "The two companies, numbering 200 employees, are bound together by

the same mission: the quality of their components and attention to the environment", declares Sisto Fini. "Our company stakes everything on quality and competitiveness, without ever forgetting environmental sustainability and the need to look after the local area", continues Fini. "In fact we focus firmly on social and environmental sustainability, paying the utmost attention to environmental issues and taking care of the area we live in."

The Compounds and Mechanical Machining Division handles the design, de-

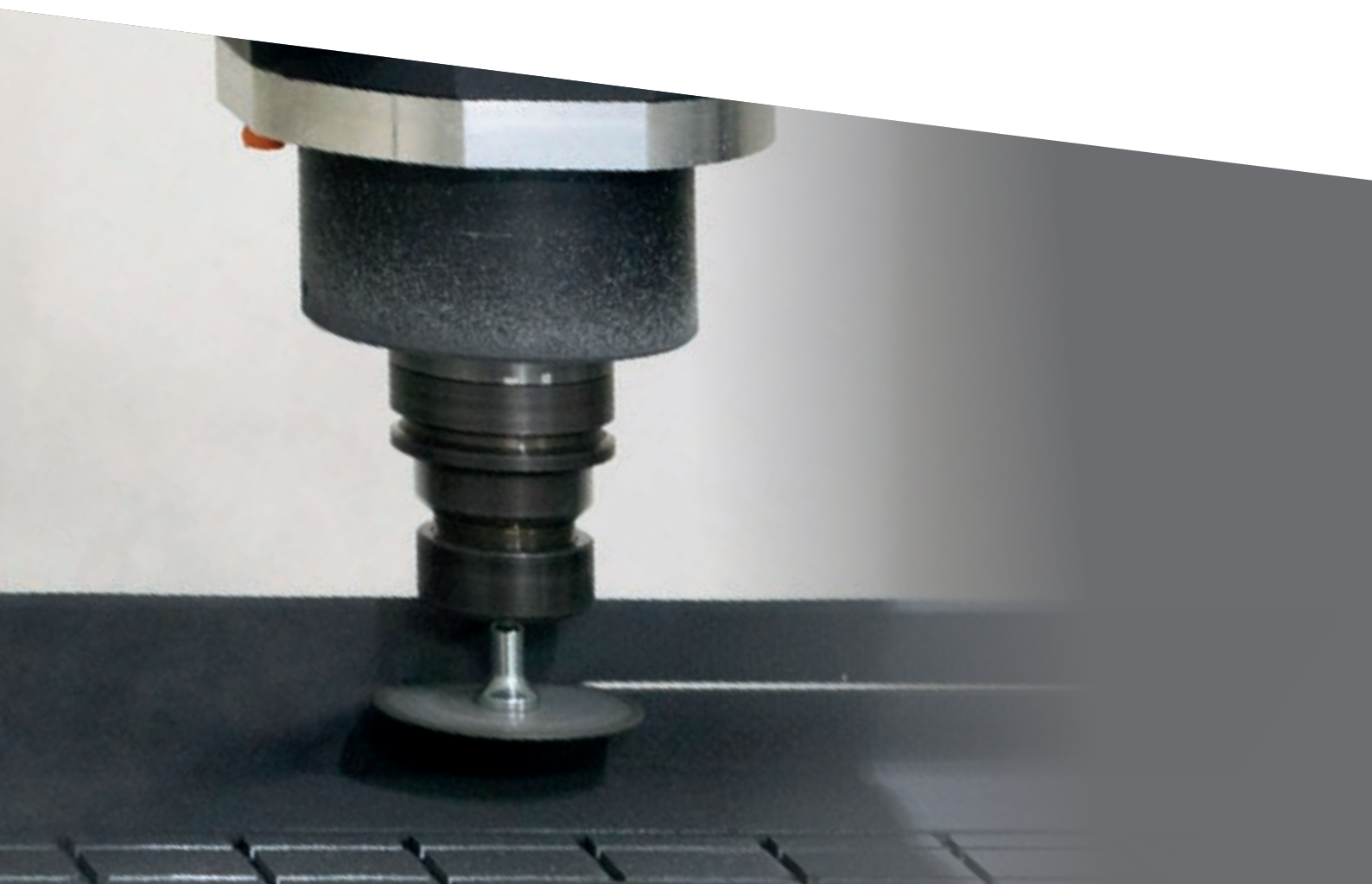



velopment and machining of the compound material - primarily carbon fibre, glass fibre and kevlar pre-impregnated with epoxy resin - by means of cutting, profiling, gluing and polymerisation. In addition, the components are subjected to continuous laboratory tests, dimensional tests and destructive/non-destructive tests. The Systems and Constructions Division of Tecnologie Avanzate, on the other hand, deals with the design, development and construction of mechanical and industrial systems (or the renovation of existing ones) for the production of components made of compound materials. "We work in a highly dynamic sector that calls for quality and great competitiveness. Our main customers are world leaders including Boeing, Leonardo Aerostutture and Leonardo Elicotteri, inter-

nationally recognised as the foremost aeroplane manufacturers", says Flavio Mandato, Sales Manager with Tecnologie Avanzate for more than 7 years. "Our most significant strength, apart from the total quality imposed by the aeronautical standards, is our intense competitiveness. Being competitive in this sector is our goal, seeing as we deal with the leading worldwide producers", concludes Mandato.

"Our collaboration with Biesse began in 2018, when we purchased a Primus 322. It turned out to be a positive choice right from the start, as we noted advantages that were very important for us: easy, clear maintenance, simplified resetting and advanced functions for managing tool paths", explains Maurizio Patriarca, Quality Manager for more than 20 years.

In the following years, the company extended its machine stock with the purchase of the Materia LD and Rover Plast A FT 5-axis machining centres, and a Selco Plast panel saw. "The Materia LD in particular was chosen for the degree of precision it maintains even during mechanical machining operations of considerable size, complying with the requirements of the strict product tolerance values. Machining accuracy is an attribute that can't be forfeited in a sector like the aeronautical one", concludes Sisto Fini.

"We chose Biesse for the degree of precision it guarantees us, even during mechanical machining operations of considerable size, complying with the requirements of the strict product tolerance values."

Founded in Italy,  
international native.

We simplify your  
manufacturing  
to make the process  
of any material



ur  
g process  
potential  
l shine.

We are an international company that manufactures integrated lines and machines to process wood, glass, stone, plastic and composite materials and what will come next.

Thanks to our rooted competence nurtured by an ever-growing worldwide network, we support your business evolution – empowering your imagination.

**Master of materials, since 1969.**

Join the  
Biesse world.

[biesse.com](https://www.biesse.com)



