

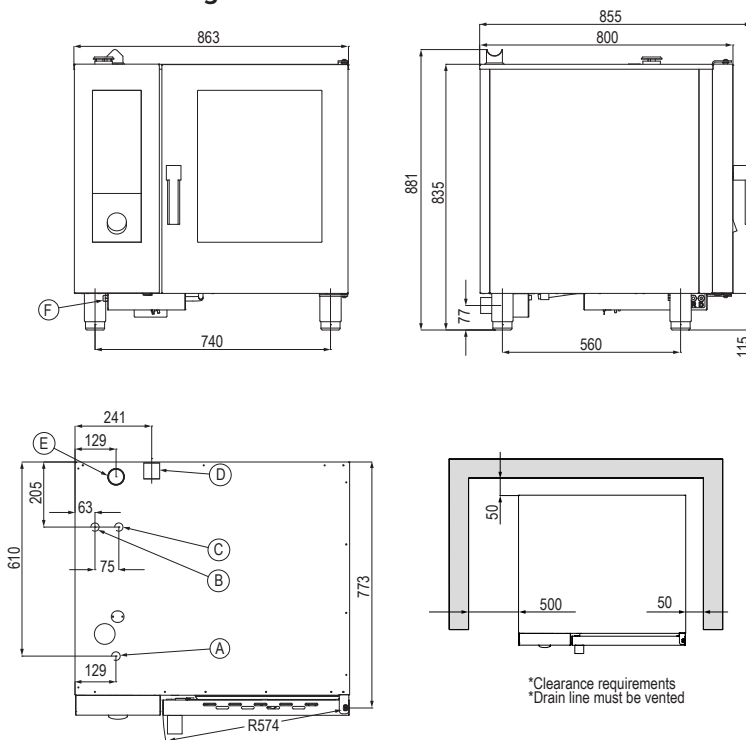

Product Information:

- **Symbiotic Steam (patented)** innovative, heavy duty, highly efficient, dual boiler generation and steam injection oven
- **Steam Tuner (patented)** exclusive feature allows actual tuning of saturated steam
- **Meteo System (patented)** for precise control and saturation levels
- Automatic descaling system for oven and boiler
- Integrated recirculating cleaning via tablet, with liquid detergent dispenser installed if preferred
- Large 9" innovative touch screen interface
- Over 120 pre-set cooking programs, 1,000+ additional programs - 9 phase memory available
- Automatic, adaptive cooking, rack control, regeneration, sous vide and smoking programs
- Easy Service function, Recipe tuner, and Chef's note software all as standard
- 6-speed inverter controlled fan for increased precision, control and reliability
- LED lighting for superior cavity illumination
- USB connection, HACCP
- Supplied with integrated hand shower, multi-point core temperature probe, drain kit and advanced scale reduction filter
- Left hand hinge door option available, this variation is 30mm wider and is made to order
- All combi ovens are supplied with either Standard or Reverse Osmosis Filtration system
- 48-month warranty (Terms and conditions apply)

General Drawing:



Specifications

Model - Standard Filter	SEHE061WT.SF
Model - Reverse Osmosis	SEHE061WT.RO
W x D x H (mm)	863 x 855 x 881
Weight	132kg
Capacity	6 x 1/1 GN Pans
Packed Dimensions (mm) / Weight	
Electrical Connection	3Ø + N + E 415VAC / 50Hz / 12.4kW
Cold Water Connection	3/4 BSP 150-350 kpa Min 10°C - Max 35°C
Water Quality Requirements	Hardness 60-100ppm TDS <100mg/L Cl Chloride <32mg/L

Legend:

- A** Electrical Connection
- B** Steam Generation Water Inlet 3/4" BSP
- C** Wash System Water Inlet 3/4" BSP
- D** Drain Connection 50mm
- E** Humidity Vent
- F** Detergent & Rinse Aid Inlet

Heat Source: 500mm clearance from an external heat source is required in order to protect the oven control components and allow access to the service panel. For clearances under 500mm, it is mandatory for Stoddart heat shields to be fitted while still maintaining a minimum clearance of 300mm to provide access to the service compartment. Failure to adhere to minimum clearances may void the oven warranty or add service costs due to lack of access.

Non-Heat Source: Generally 300mm clearance is required from the control panel side to allow access to the service panel. Any distance under 300mm, may add service costs due to lack of access.

Due to continuous product research and development, the information contained herein is subject to change without notice.

Revision: 04 - 09/02/2022 - A

www.stoddart.com.au

www.stoddart.co.nz

