



CURIE Plus

Essential User Guide

Your shortcut to successful printing



Register Your
Device & Warranty

Product Overview

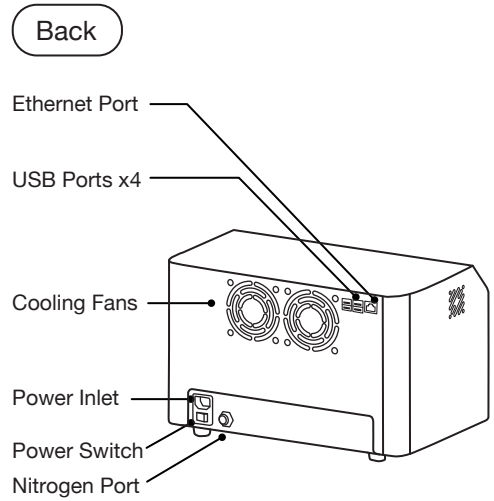
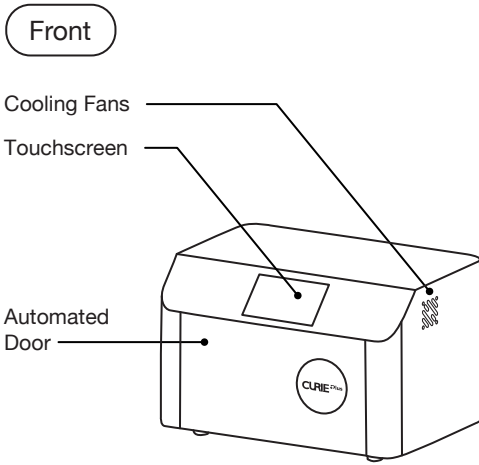

Setup Guide

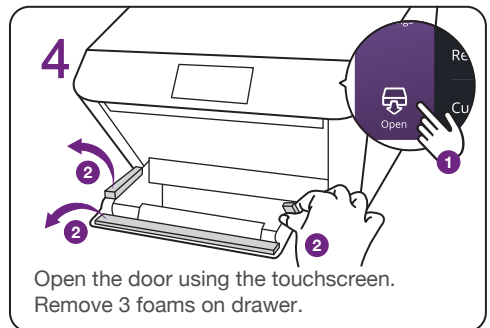
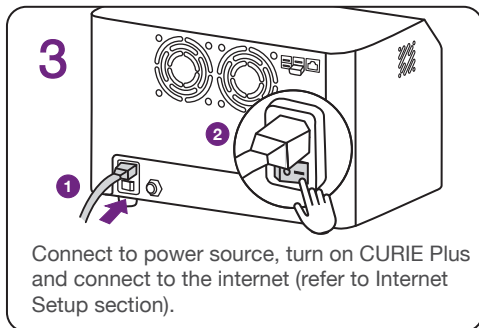
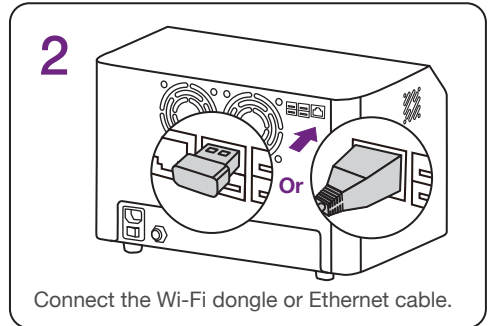
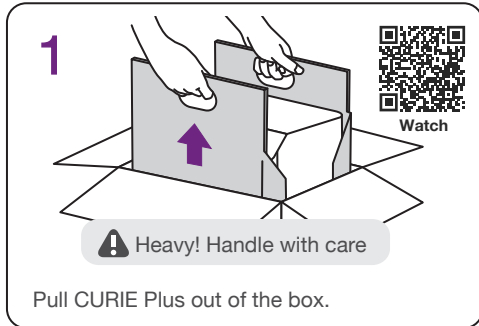

Operate CURIE Plus in a dry, well-ventilated indoor environment at a maximum altitude of 2000 m (6561.7 ft), with a temperature range of 18°- 25° C (64°- 77° F), a maximum relative humidity of 80%, and a pollution degree of 2. The main supply voltage fluctuations must be ≤ 10%, with an overvoltage category II.

Package Contents



CURIE Plus



N2 Cover



Glass Panel



Power Cable



Ethernet Cable



Wi-Fi Dongle

Curing Process

1

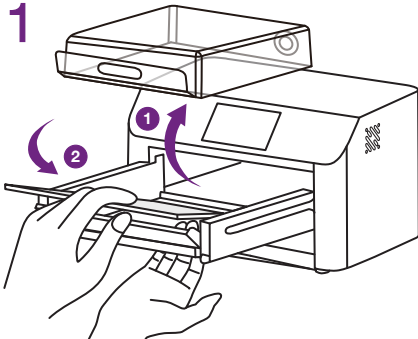

Take out the N2 Cover, and place the glass inside the curing chamber. Use your hand to position the glass from the bottom.

2

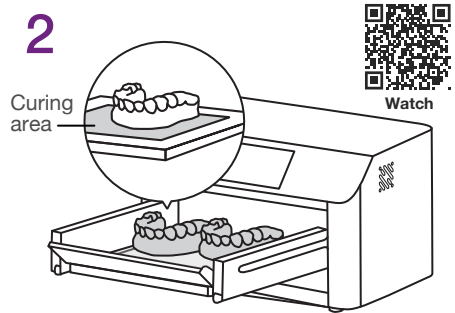

! Do not stack applications

Place the applications flat inside the glass curing area.

3

Optional:
For nitrogen process only



Learn More

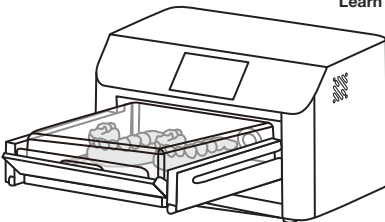

Place the N2 Cover on top with the handle facing towards you.

4

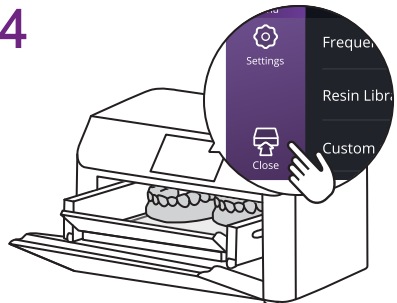

! Keep hands away from door

Close the door using the touchscreen.



The maximum operation time for CURIE Plus is 20 minutes, with a minimum rest time of 15 minutes between curing cycles. CURIE Plus is equipped with Thermal Protection Mode, which may be activated if curing continuously at a maximum load for up to 20 minutes.

Curing Parameters

There are 4 ways to set the curing parameters:

- **Recent Prints**
Latest prints from your SOL SE or SOL Plus
- **Frequently Used Resins**
10 most commonly used resins
- **Resin Library**
Most up-to-date library
- **Custom Curing Parameters**
User parameters setup

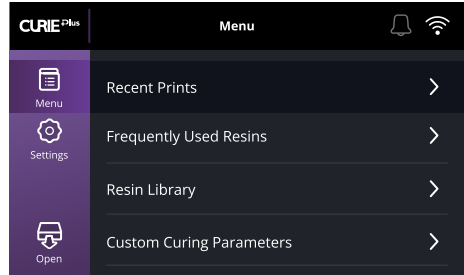

Internet Setup

There are two ways to establish an internet connection:

- **Wi-Fi**
- **Ethernet**

If you have a SOL SE or SOL Plus:

Before the printer has finished printing, connect CURIE Plus to the same network. CURIE Plus will receive the curing parameters of the successful prints in "Recent Prints".

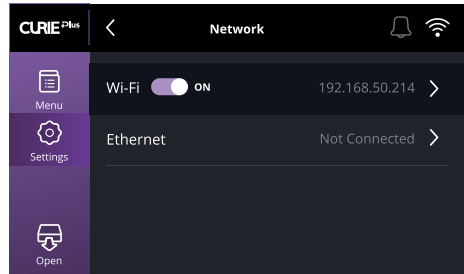

Firmware Update

Update to the latest firmware version:

- **System Update via Internet** (recommended)
- **System Update by USB**

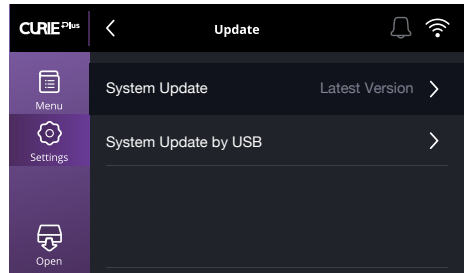

Technical Specifications

Dimensions 36.6 (W) x 26 (D) x 23.4 (H) cm
14.4 (W) x 10.2 (D) x 9.2 (H) in

Weight 12.2 kg
26.9 lbs

Power Input 100-240VAC, 50-60Hz

UV Wavelength 365, 385, and 405 nm

Chamber Dimensions 20 (W) x 15 (D) x 6 (H) cm
7.9 (W) x 5.9 (D) x 2.4 (H) in

LED Lights 65



Frequently Asked Questions

Q1 I have just received CURIE Plus, how do I get started?

After receiving your CURIE Plus, register your device through the User Dashboard so that your warranty is activated on the date of purchase. The User Dashboard contains resources to help you get started, access troubleshooting, and get support from the Ackuretta Customer Success Team. To find more information about the User Dashboard and warranty policy, scan the following QR codes.

After unboxing, plug in the Wi-Fi dongle and power cable, turn on your CURIE Plus, and follow the steps shown in the Quick Start Guide.

- Open the door using the touchscreen.
- Remove the N2 Cover, which will only be used when curing with nitrogen (see Q5).
- Place the glass onto the sliding drawer. The UV light is concentrated in the curing area outlined by the black rectangle on the glass so make sure applications are placed inside this area.
- Select the resin used to print your applications and press 'Start' to begin the curing process.

To watch the unboxing video, scan the QR code below.



Note: When working with devices with UV lights like CURIE Plus, it is recommended to wear UV protective goggles for your safety.



User
Dashboard

Learn More



CURIE Plus
Warranty Policy

Learn More



CURIE Plus
Unboxing Video

Watch

Q2 Why does CURIE Plus require an internet connection?

We recommend connecting CURIE Plus to the internet via Wi-Fi or Ethernet to enable automatic Resin **Library updates**. This feature enhances the user experience by ensuring your equipment is always up to date with the newest resin profiles and improvements to existing curing parameters.

Whenever a **firmware** update is released, you can update your CURIE Plus by tapping on the notification on the 'Bell' icon.

While CURIE Plus can be used without an internet connection, the Resin Library and firmware will not be updated when offline. To avoid curing issues, take it online at least once every seven days to ensure your Resin Library and firmware are up to date.

Q3 How does the connection between CURIE Plus and SOL SE or SOL Plus streamline the curing process?

CURIE Plus will load the resin parameters from the latest prints directly from your SOL SE(s) and SOL Plus(es).

Before your printer has finished printing, turn on CURIE Plus and connect to the same network as the printer. Once the printing is completed and you have confirmed "Print Successful," CURIE Plus will receive the curing parameters of the successful prints. From the "Recent Prints" menu, select the print you wish to cure and curing will begin automatically.

This feature provides a seamless integration with a one-click workflow from printing to curing, ensuring accurate curing parameters, and helping to prevent curing errors. To use this feature, make sure your SOL SE or SOL Plus is updated to the latest firmware.

Q4 What are the benefits of using nitrogen with CURIE Plus?

CURIE Plus is built to integrate a nitrogen flow into the UV chamber. While oxygen has a UV inhibition effect that can reduce curing performance, nitrogen is an inert gas that helps create an oxygen-free environment inside the chamber. Displacing oxygen with nitrogen during the curing process improves the quality of the prints by strengthening mechanical properties.

Q5 Can I use a third-party nitrogen tank or nitrogen generator with my CURIE Plus?

Yes. When selecting a third-party nitrogen tank, **please ensure it follows the specifications** outlined in the SOP. Due to the range of possible variables, we cannot provide specifications for the use of a third-party nitrogen generator.

While CURIE Plus is compatible with third-party nitrogen sources, we cannot assure the quality of 3D printed applications using third-party equipment and assume no responsibility for the final results.

To learn more about how to use CURIE Plus with a nitrogen tank, scan the QR code.



Learn More

Q6 What is the size of the curing area inside CURIE Plus?

The curing area is 20 x 15 cm. It can accommodate up to 8 full arches at the same time.

Q7 Can I use my own curing settings?

Yes. You can create up to 5 custom curing profiles, with or without nitrogen settings. Go to Menu > Custom Curing Parameters, select your curing mode, then enter Time, Power, Duty Cycle, and choose Bottom Light ON or OFF.

Q8 How can I clean the glass in my CURIE Plus?

The glass can be cleaned by using a cloth with 95% alcohol. As dirty glass can reduce the curing performance and compromise the biocompatibility of your 3D printed applications, regularly check the glass and clean it as needed.

Q9 What does "Validation In Progress" mean?

"Validation In Progress" resins are calibrated by Ackuretta but not yet officially validated by their manufacturers for CURIE Plus.

We are continuously working with the resin manufacturers to validate their resins on CURIE Plus. Once the resin is officially validated by the manufacturer, its "Validation In Progress" status on CURIE Plus will be removed.

Even though these resins are not yet validated by the manufacturers, the parameters have been calibrated by Ackuretta in order to achieve optimal cure performance.

Q10 How do I safely turn off my CURIE Plus?

Switch off your CURIE Plus using the power switch on the back of the machine and disconnect the power cable.



 **ACKURETTA**
A PacDent Company



 User Dashboard



 Facebook User Group



ACKURETTA

A Pac-Dent Company