

Operating instructions

Chest freezer

Read the operating instructions before switching on for the first time

Page 14

GB

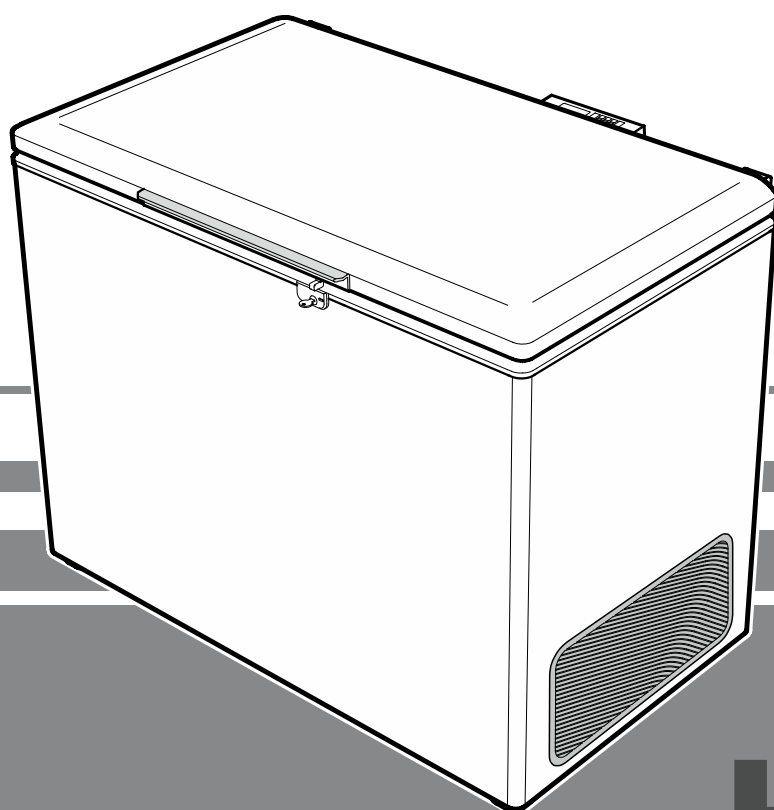

7084 679-01

LGT

LIEBHERR

Disposal notes

The appliance contains reusable materials and should be disposed of properly - not simply with unsorted household refuse. Appliances which are no longer needed must be disposed of in a professional and appropriate way, in accordance with the current local regulations and laws.



When disposing of the appliance, ensure that the refrigerant circuit is not damaged to prevent uncontrolled escape of the refrigerant it contains (data on type plate) and oil.

- Disable the appliance.
- Pull out the mains plug.
- Cut through the connection cable.

WARNING

Danger of suffocation due to packing material and plastic film!

Do not allow children to play with packaging material.

Take the packaging material to an official collection point.

Other features

- Audible and visual temperature alarm (adjustable limits).
- Audible and visual alarm if the lid is left open for too long.
- Floating contact for connection to a remote monitoring system.
- Serial interface (RS485) for external temperature and alarm documentation.
- Maximum/minimum interior temperatures are stored.
- Last 3 temperature alarms are saved with time, date and duration of alarm.
- Last 3 power cuts are saved with time, date and duration of power cut.
- Opening for installing a reference sensor.

It is essential to use these safety facilities to avoid damage to stored items. These facilities must not be deactivated or decommissioned!

The appliance complies with the relevant safety regulations and EC Directives 2004/108/EC and 2006/95/EC.

Description of the appliance

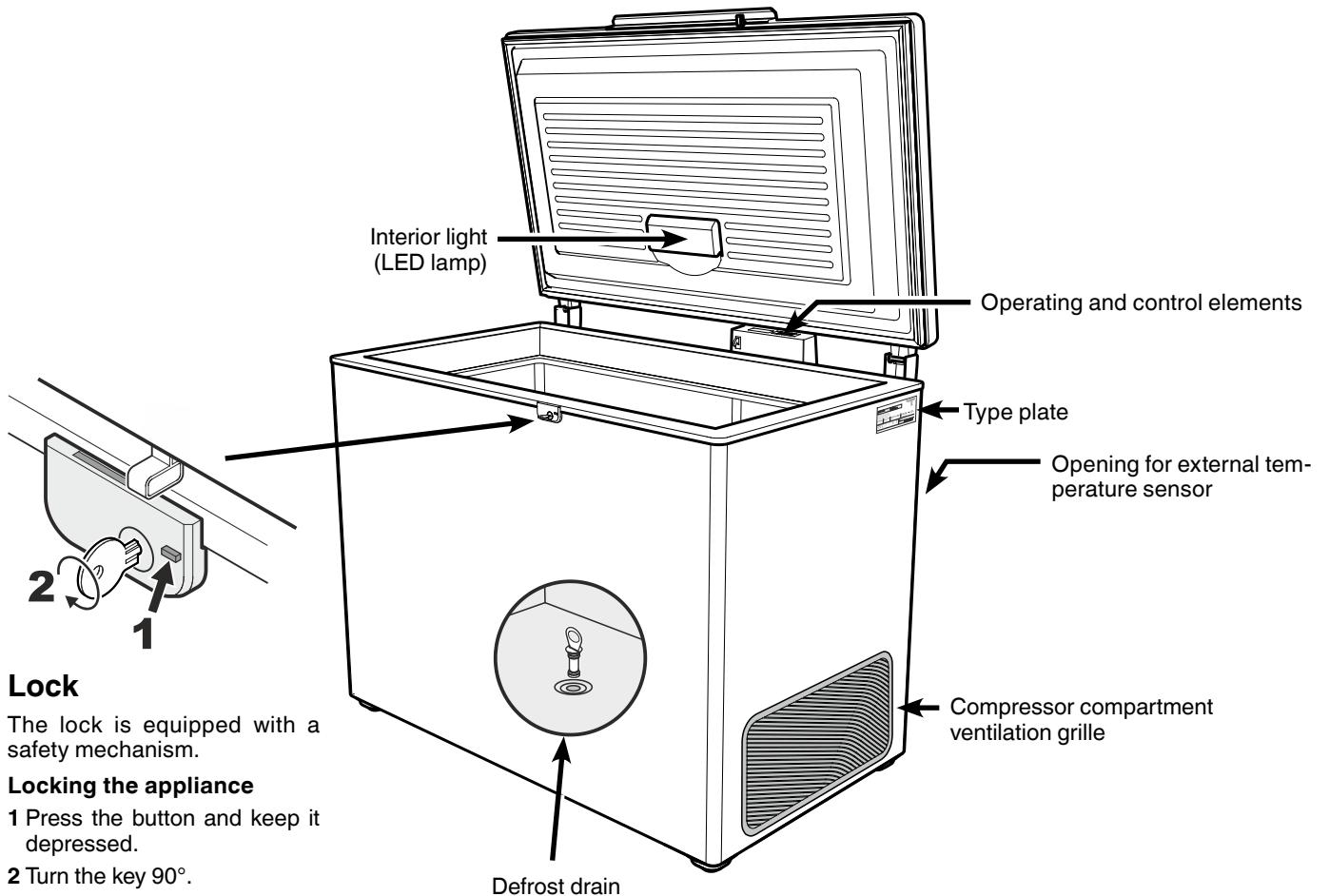

Lock

The lock is equipped with a safety mechanism.

Locking the appliance

1 Press the button and keep it depressed.

2 Turn the key 90°.

Safety instructions and warnings

- To prevent injury or damage to the unit, the appliance should be unpacked and set up by two people.
- In the event that the appliance is damaged on delivery, contact the supplier immediately before connecting to the mains.
- To guarantee safe operation, ensure that the appliance is set up and connected as described in these operating instructions.
- Disconnect the appliance from the mains if any fault occurs. Pull out the plug, switch off or remove the fuse.
- When disconnecting the appliance, pull on the plug, not on the cable.
- Any repairs and work on the appliance should only be carried out by the customer service department, as unauthorised work could prove highly dangerous for the user. The same applies to changing the mains power cable.
- Do not allow naked flames or ignition sources to enter the appliance. When transporting and cleaning the appliance, ensure that the refrigerant circuit is not damaged. In the event of damage, make sure that there are no ignition sources nearby and keep the room well ventilated.
- This appliance can be used by children of 8 years old and over, and also by persons with restricted physical, sensory or mental capacity or lack of experience and knowledge, if they are supervised or have been instructed on safe use of the appliance and understand the resulting risks. Children must not be allowed to play with the appliance. Cleaning and user maintenance must not be carried out by children without supervision.
- Avoid prolonged skin contact with cold surfaces or chilled/frozen food. This could cause pain, numbness and frostbite. In the case of prolonged skin contact, protective measures should be taken, e.g. gloves should be worn.
- Do not consume food which has been stored for too long, as it could cause food poisoning.
- Do not store explosives or sprays using combustible propellants such as butane, propane, pentane, etc. in the appliance. Electrical components might cause leaking gas to ignite. You may identify such sprays by the printed contents or a flame symbol.
- Do not use electrical appliances inside the appliance.
- If you have a lockable appliance, do not keep the key near the appliance or within reach of children.
- The appliance is designed for use in enclosed areas. Do not operate the appliance outdoors or in areas where it is exposed to splash water or damp conditions.
- The LED lamp is designed to illuminate the interior of the appliance. It is not suitable for lighting a room.
- Do not install the appliance in the immediate vicinity of an air-conditioning unit. The appliance should also not be operated under a wall-mounted air-conditioning unit.
- The appliance is **not** suitable for storing drugs pursuant to DIN 58345.
- The appliance is **not** suitable for storing blood bottles pursuant to DIN 58371.
- The appliance is **not** suitable for storing blood plasma pursuant to DIN 58375.
- In special fields of application which are subject to their own standard, the user is responsible for complying with this standard.

Range of appliance use

The appliance is suitable for storing and cooling of laboratory preparations at temperatures of between -10°C and -45°C .

The appliance is **not** suitable for use in explosion-hazard areas.

For the storage of valuable or temperature-sensitive substances or products the use of an independent, constantly monitoring alarm system is necessary.

This alarm system must be designed so that each alarm status is detected immediately by an authorised person who can then take appropriate action.

Position the temperature sensor for this system in the upper part of the interior container (see **Opening for external temperature sensor**).

Climate rating

The climate rating indicates the room temperature at which the appliance may be operated in order to achieve full refrigeration performance.

The climate rating is indicated on the type plate.

The position of the type plate is shown in the section entitled **Description of the appliance**.

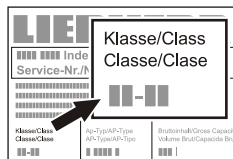

Climate rating	Room temperature
SN	$+10^{\circ}\text{C}$ to $+32^{\circ}\text{C}$
N	$+16^{\circ}\text{C}$ to $+32^{\circ}\text{C}$
ST	$+16^{\circ}\text{C}$ to $+38^{\circ}\text{C}$
T	$+16^{\circ}\text{C}$ to $+43^{\circ}\text{C}$
SN-ST	$+10^{\circ}\text{C}$ to $+38^{\circ}\text{C}$
SN-T	$+10^{\circ}\text{C}$ to $+43^{\circ}\text{C}$

Do not operate the appliance outside the specified room temperature range.

Appliance dimensions (mm)

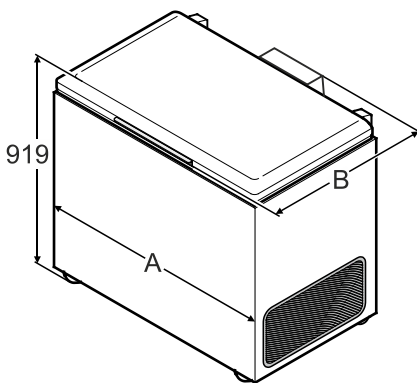

	A	B
LGT 2325	1132	737
LGT 3725	1373	786
LGT 4725	1648	786

Setting up

- Avoid positioning the appliance in direct sunlight or near cookers, radiators and similar sources of heat.
- The floor on which the appliance stands must be horizontal and level. Place the appliance far enough away from the wall so that the lid can be opened and closed unhindered.

- ① Do not cover the gap between the lower edge of the freezer and the floor, as the refrigeration unit has to be supplied with air for cooling.

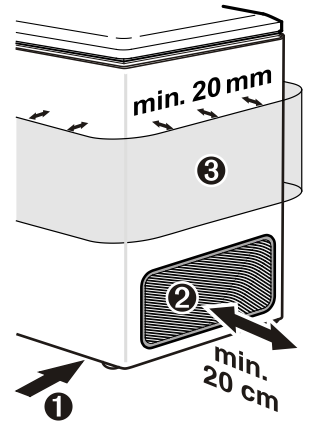

- ② There must be a gap of at least 20 cm between the ventilation grille and the wall. This gap must be kept clear and the ventilation openings uncovered.

- ③ Do not place any objects immediately next to the outer housing of the appliance. There must be a gap of at least 20 mm all round in order to ensure adequate heat discharge.

- Standard EN 378 specifies that the room in which you install your appliance must have a volume of 1 m^3 per 8 g of R 290 refrigerant used in the appliance, so as to avoid the formation of inflammable gas/air mixtures in the room where the appliance is located in the event of a leak in the refrigerant circuit. The quantity of refrigerant used in your appliance is indicated on the type plate.

Electrical connection

Only operate the appliance with **alternating current (AC)**.

The permissible voltage and frequency are indicated on the type plate. The position of the type plate is shown in the section entitled **Description of the appliance**.

The socket must be properly earthed and protected by a fuse.

The tripping current of the fuse must be between 10 A and 16 A.

The socket must not be situated behind the appliance and must be easily accessible.

Do not connect the appliance using an extension cable or extension socket.

Do not use stand-alone inverters (conversion of direct current to alternating/three-phase current) or energy-saving plugs. Risk of damage to the electronic control system!

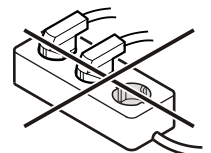

Operating and control elements

- ① **ON/OFF** button (to switch the appliance on and off)
- ② Selection buttons
- ③ **Set** button (Enter)
- ④ **Audible warning** on/off button
- ⑤ Button for calling up stored alarm events
- ⑥ Temperature display

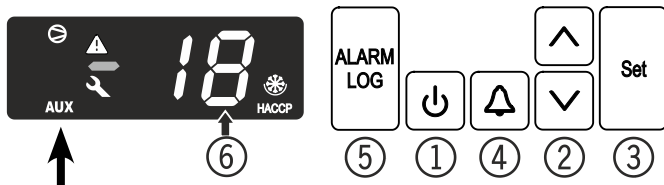

Control elements

- Compressor is running
- LED flashing - refrigeration unit switches on after a delay. The compressor will start automatically after the pressure in the refrigerant circuit has equalised.)

AUX Temperature display via product sensor is activated

- Alarm function
- If appears in the display, the appliance has a fault. Consult your nearest customer service point.

HACCP (Hazard Analysis Critical Control Point)

The HACCP display means that the power supply and interior temperature of the appliance are recorded. If HACCP flashes in the display, there has either been a power failure or the temperature in the appliance exceeded the permissible range.

Switching the appliance on and off

Connect the appliance to the mains - the display reads **OFF**.

Switching the appliance on: Keep the **ON/OFF** button pressed for approx. 5 seconds - the display reads **ON**.

No alarm is displayed or sounded when the appliance is switched on for the first time.

If the appliance is disconnected from the mains for a long time after it has been switched on for the first time and if the temperature inside the appliance rises above the upper alarm limit, this will be detected as a fault by the electronic control system (**HACCP** appears in the display).

When the appliance is switched on again, this display must be reset as shown below.

Press button .

Press + for 5 seconds. The display will read **rES**.

The **HACCP** LED will now light up permanently.

Press for 5 seconds.

The electronic control system will switch back to normal operating mode.

Switching the appliance off: Keep the **ON/OFF** button pressed for approx. 5 seconds - the display reads **OFF**.

Setting the temperature

- Press button for 1 second. The temperature display flashes.
- To increase the temperature (warmer): press button .
- To reduce the temperature (colder): press button .
- Press button again.

The desired temperature setting is saved.

Audible warning signal

The audible warning signal will sound in certain alarm events.

It can be cancelled by pressing button .

Lid open alarm

When the lid is opened, the LED lights up and the temperature display begins to flash.

When the lid has been left open for more than 60 seconds, the LED begins to flash, and **door** and the temperature indication flash alternately in the display.

The audible warning signal sounds (unless the audible warning signal function has been deactivated).

If the lid has to stay open for longer in order to insert items to be cooled, cancel the audible warning signal by pressing button .

If the lid is open, the audible warning signal can also be muted by pressing the contact switch on the electronics housing. This will disable the audible warning signal for 60 seconds.

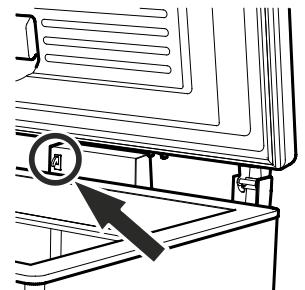

Setting the delay time for the lid open alarm

The time before the audible warning signal sounds after the lid has been opened can be adjusted.

Press for 5 seconds. Display = *r61*

Display = *rA3*

Display = *rC1*

Display = *rC3*

Display = *d8d*

Display = *1* (minute)

Setting range = 1 - 5 minutes

Use buttons and to select the desired setting.

Display = *d8d*

Press for 5 seconds.

The electronic control system will switch back to normal operating mode.

Deactivating the audible warning signal function

The audible warning signal function can be completely deactivated if necessary.

Note

In this case, the sentence stated in these operating instructions "The audible warning signal sounds" must be skipped when reading the section in question.

Press for 5 seconds. Display = *r61*

Display = *tc*

Display = *H4*

Display = *0*

Use buttons and to select the desired setting.

0 = audible warning signal function activated

1 = audible warning signal function deactivated

Display = *H4*

Press for 5 seconds.

The electronic control system will switch back to normal operating mode.

Audible warning signal settings

The audible warning signal will be muted for the current alarm after the button has been pressed. Complete the following steps if you want the audible warning signal to reactivate automatically.

Press for 5 seconds. Display = *r61*

Display = *tc*

Display = *H4*

Display = *H0*

Display = *ASd*

Display = *ASn*

Display = *0*

Display = *1*

Display = *ASn*

Automatic reactivation of the audible warning signal is now active.

The time before the audible warning signal sounds again must be set.

Display = *ASd*

Display = *1* Time in minutes after which the audible warning signal will sound again after the button has been pressed. Setting range = 1 - 120 minutes.

Use buttons and to select the desired setting.

Display = *ASd*

Press for 5 seconds.

The electronic control system will switch back to normal operating mode.

Alarm messages

1. LED flashes

If  appears in the display, the appliance has a fault. Consult your nearest customer service point.

2. LED flashes, the display reads *HI* or *LO*

The interior is too warm (HI) or too cold (LO).

The audible warning signal sounds (unless the audible warning signal function has been deactivated).

Note

The alarm parameters can be adjusted. See **Adjusting the alarm parameters**.

3. HA/HF/HACCP flashes

There has been a power cut (HF) of some length or the interior was too warm or too cold (HA) during a certain period of time.

Up to three alarm events can be stored and called up.

Alarm test

This test checks the function of the internal and any external connected alarm device.

The appliance does not stop its refrigerating function during this test.

Activating the test

Press  +  for 5 seconds.

- The display will change to a temperature value of 0.2°C below the set upper alarm limit.
- The temperature value will now rise by 0.1°C every 2 seconds.
- When the upper alarm limit is reached, *HI0* will appear in the display. An external alarm unit connected to the floating alarm output will now be activated.
- The temperature value will continue to rise up to 0.2°C above the upper alarm limit.
- The same process will take place automatically for the lower alarm limit. *LI0* will appear in the display.

The LED  will be lit during the test.

The electronic control system will automatically switch back to normal operating mode.

Cancelling the test prematurely

Press  for 5 seconds.

Note

If the values of the upper and lower alarm limit (**AL** and **AH** in the section entitled "Adjusting the alarm parameters") are set to **0**, **H-** - and **L-** - will appear in the display during this test.

Adjusting the alarm parameters

The alarm limits (difference to the set temperature) and the alarm delay (delay until alarm goes on) can be adjusted.

Press  for 5 seconds. Display = *r61*

 Display = *rA3*



 Display = *rC1*

 Display = *rC3*

 Display = *d8d*

 Display = *AL* Lower alarm limit

 Display = temperature difference in °C

Use buttons  and  to select the desired setting.



Important note

Set positive values only.

 Display = *AL*

 Display = *AH* Upper alarm limit

 Display = temperature difference in °C

Use buttons  and  to select the desired setting.



Important note

Set positive values only.

 Display = *AH*

 Display = *Ad*

 Display = alarm delay in minutes

Use buttons  and  to select the desired setting.

 Display = *Ad*

Press  for 5 seconds.

The electronic control system will switch back to normal operating mode.

Calling up stored alarm events and reading the temperature progression

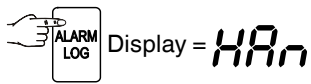

Scroll through the list using or .

- HAn** Number of temperature alarms
- HA** Last temperature alarm
- HA 1** Last temperature alarm but one
- HA 2** Temperature alarm before **HA 1**
- HF_n** Number of power cuts
- HF** Last power cut
- HF 1** Last power cut but one
- HF 2** Power cut before **HF 1**
- r_t** Period in hours in which the maximum and minimum interior temperatures were measured
- r_H** Maximum (highest) measured temperature
- r_L** Lowest measured temperature

Select the required item using the button. Press this button again to return to the list.

Note: You can exit the menu at any time by pressing for 5 seconds.

If no button is pressed within 60 seconds, the electronic control system switches back automatically.

Resetting the recorded temperature progression **r_t**

Complete the following steps if you wish to reset the value saved for **r_t** in the previous section to 0.

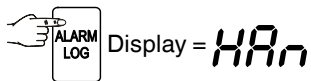

Press the button or until **r_t** appears in the display.

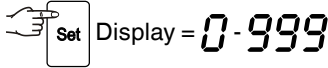

Press for 5 seconds. Display = **r_tES**.

The values for **r_H** and **r_L** (highest and lowest measured interior temperature) are then reset to the current interior temperature.

Press for 5 seconds.

The electronic control system will switch back to normal operating mode.

Example of an alarm query

Situation: **HA/HF/HACCP** flashes in the display.



Display = **0** There has not been an alarm status with a too high or too low temperature. You must switch to display **HF_n**.



Press this button until **HF_n** appears in the display.

Display = **1 1** power failure has occurred.



Display = **HF** Last power failure.

Display = **Y 14** Year 2014

Display = **n05** Month 05 (May)

Display = **d30** Day 30

Display = **h23** Hour 23

Display = **m 14** Minute 14

Display = **t03** The power failure lasted 3 hours.

Press + for 5 seconds. The display will read **r_tES**.

The **HACCP** LED will now light up permanently.

HA/HF is cancelled in the display.

The electronic control system is now ready for the next alarm.

Press for 5 seconds.

The electronic control system will switch back to normal operating mode.

Calibrating the control sensor (standard sensor for temperature control)

Possible tolerances of the control sensor (the displayed temperature compared to the actual interior temperature) can be offset with this function.

Press for 5 seconds. Display = *r61*

Display = *rA3*

Display = *rC1*

Display = correction value set at the factory

Use buttons or to increase or decrease the correction value in 0.1°C increments.

Display = actual (corrected) interior temperature

Display = *rC1*

Press for 5 seconds.

The electronic control system will switch back to normal operating mode.

Product sensor (available accessory)

The temperature may be measured or recorded at any point in the interior using the product sensor.

- Connect sensor (see section entitled **External alarm**)

Activating the sensor

Press for 5 seconds. Display = *r61*

Display = *rA3*

Display = *0*

Display = *1*

Display = *rA3*

Press for 5 seconds.

The electronic control system will switch back to normal operating mode.

If *---* appears in the display, the product sensor has not been activated.

If *E2* appears in the display, the product sensor has not been connected, or is faulty.

Calibrating the product sensor

Possible tolerances of the product sensor (the set temperature compared to the actual interior temperature) can be offset with this function.

Press for 5 seconds. Display = *r61*

Display = *rA3*

Display = *rC1*

Display = *rC3*

Display = *0.0*

Use buttons or to increase or decrease the correction value in 0.1°C increments.

Display = actual (corrected) product sensor temperature

Press for 5 seconds.

The electronic control system will switch back to normal operating mode.

Switching the temperature display between control sensor and product sensor

Press for 5 seconds. Display = *r61*

Display = *1* (control sensor)

Display = *2* (product sensor)

If the product sensor is activated, AUX appears in the display.



Display = *r61*

Press for 5 seconds.

The electronic control system will switch back to normal operating mode.

Changing the network address

When connecting several appliances via the RS485 interface, each appliance must have its own network address.

Press for 5 seconds. Display = *rt1*

Display = *tc*

Display = *44*

Display = *40*

Display = *!*

Use buttons or to change the network address (*1-207*).

Display = *40*

Press for 5 seconds.

The electronic control system will switch back to normal operating mode.

Resetting the parameters to factory settings

The **alarm limits** and **sensor calibration values** can be reset to the factory settings using this function.

Pull out the mains plug.

Keep pressed and connect the mains plug.

Display = *bn1*

Display = *Std*

The electronic control system will automatically switch back to normal operating mode.

Setting the real time clock

The real time clock is preset (CET). Other time zones or summer/winter time must be adjusted manually.

Press for 5 seconds. Display = *rt1*

Display = *tc*

Display = *3 14* Year 2014

Display = *10* Set the year by pressing the buttons.

= save new setting

Display = *07* Month (1-12)

Display = *7* Set the month by pressing the buttons.

= save new setting

Display = *01* Day (1-31)

Display = *!* Set the day by pressing the buttons.

= save new setting

Display = *03* Days of the week (1 = Monday, 7 = Sunday)

Display = *3* Set the day of the week by pressing the buttons.

= save new setting

Display = *12* Hour (0-23)

Display = *12* Set the hour by pressing the buttons.

= save new setting

Display = *48* Minute (0-59)

Display = *48* Set the minutes by pressing the buttons.

= save new setting

Press for 5 seconds.

The electronic control system will switch back to normal operating mode.

Note

When *Etc* appears in the display, the real time clock must be reset.

Interior LED light

An LED lamp is fitted as standard to illuminate the interior of the appliance.

The interior light switches on automatically when the lid is opened and switches off again when it is closed.

The light intensity of the LED light corresponds to laser class 1/1M.

Important

If the cover is removed, do not look directly at the light through optical lenses from close distance. This can damage your eyes.

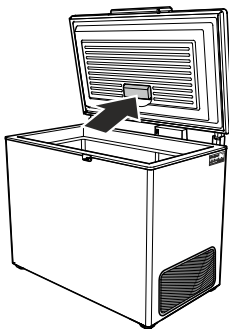

Replacing the lamp

If the lamp is defective, it can be replaced taking into account the following points.

1. Pull out the plug or switch off the fuse.
2. Remove the cover panel in the direction of the arrow.

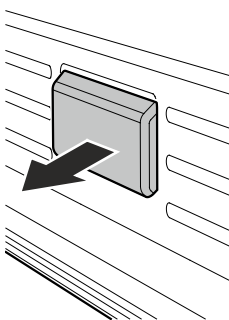

When using an LED lamp

Only original LED lamps from the appliance manufacturer may be used. The lamp can be purchased from the customer service department or specialist dealers.

WARNING!

When using LED lamps made by other manufacturers, there is a risk of overheating or fire.

When using a normal light bulb

Use a bulb of max. 15 W, bulb fitting: E14.

The voltage specified on the light bulb must correspond to the voltage given on the type plate.

The position of the type plate is shown in the section entitled **Description of the appliance**.

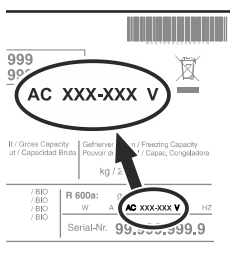

3. Unscrew the defective lamp and screw in the new one.
4. Replace the cover panel.

Defrosting

After the appliance has been in operation for some time, a layer of frost or ice will form on the inside walls. This increases energy consumption.

- Pull out the plug or switch off the fuse.

- Transfer items to other appliances.

- Remove the plug from the drain opening.

- To collect the thawed water, place a flat container below the appliance.

- Leave the lid open while defrosting. After defrosting mop up the remaining water and clean the appliance.

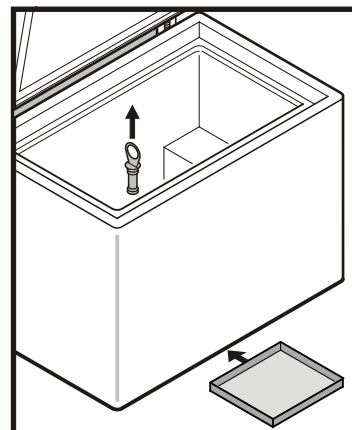

Do not use any mechanical devices or other artificial aids for defrosting other than those recommended by the manufacturer.

Cleaning

Before cleaning always switch off the appliance. Disconnect from the mains or switch off or unscrew the fuse.

- Clean the inside, equipment and outer walls with lukewarm water and a little detergent. Do not use abrasive or acid cleaners or chemical solvents.

Do not use steam cleaners because of the risk of injury and damage.

- Ensure that no cleaning water penetrates into the electrical components or ventilation grille.

- Dry all parts well with a cloth.

- The ventilation grilles should be cleaned regularly. Dust deposits increase energy consumption. Ensure that none of the wires or other components are dislodged, bent or damaged.

- Do not damage the type plate on the exterior housing of the appliance during cleaning.

Malfunctions

You may be able to rectify the following faults by checking the possible causes yourself:

- **Appliance does not function:**
 - Is the appliance switched on?
 - Is the plug correctly fitted in the mains socket?
 - Is the fuse intact?
- **Loud running noise:**
 - Is the appliance set up firmly on the floor?
 - Does the appliance cause nearby items of furniture or objects to vibrate? Please note that noises caused by the refrigerant circuit cannot be avoided.
- **The temperature is not low enough:**
 - Is the temperature setting correct (see "Setting the temperature")?
 - Does the separately installed thermometer show the correct reading?
 - Is the ventilation system working properly?
 - Is the appliance set up too close to a heat source?
- **Etc** appears in the display:
 - Reset the real time clock (see "Setting the real time clock").

If none of the above causes apply and you cannot rectify the fault yourself, contact the nearest customer service department stating the type designation ①, service number ② and appliance number ③ as indicated on the type plate.

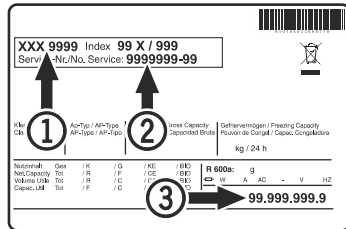

The position of the type plate is shown in the section entitled **Description of the appliance.**

Shutting your appliance down

If your appliance is to be shut down for any length of time, switch it off and disconnect the plug or switch off or unscrew the fuse.

Clean the appliance and leave the lid open in order to prevent unpleasant smells.

External alarm

We recommend connecting the appliance to an external alarm device.

There are various connection options at the back of the appliance.

The appliance may only be connected to an external alarm device by trained personnel.

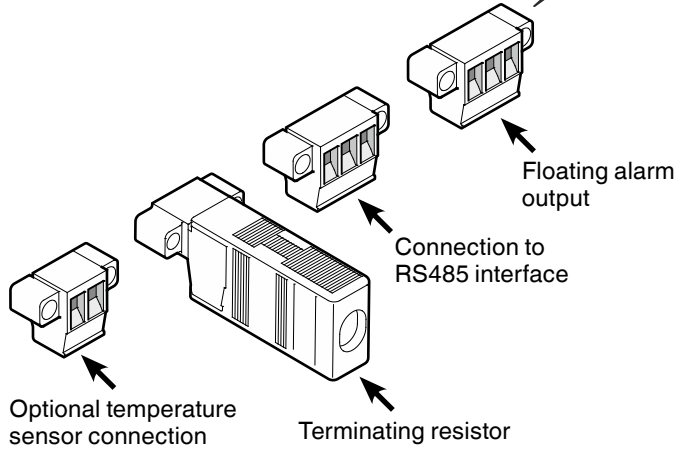
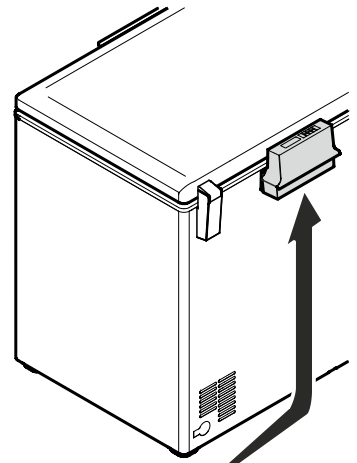

When connecting several appliances via the RS485 interface, the terminating resistor must remain on the last appliance.

Remove the terminating resistors from the appliances in between.

Note

The connectors are secured with screws. To remove the connectors, undo the left and right screws.

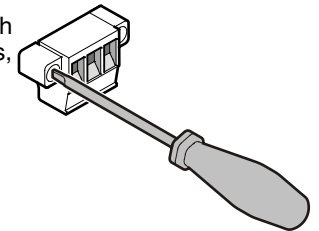

Floating alarm output

These three contacts can be used to connect the appliance to an optical or acoustic alarm device.

The connection is designed for a maximum of **42 V/8 A DC** from a safety extra-low voltage (SELV) source (**minimum current: 150 mA**).

Important

When supplying mains voltage to the floating alarm contact, the technical safety requirements of standard EN 60335 will not be satisfied.

N.O

Alarm output

Connection for a visual warning light or an acoustic alarm signal.

N.C

Operating light

Connection for a control lamp to indicate that the appliance is in normal mode.

COM

External power supply unit

42 V/8 A DC maximum
Minimum current: 150 mA

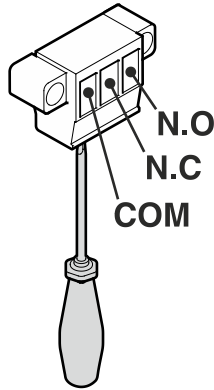

RS485 interface

Rx- / Tx-

Send/Receive data cable (negative pole)

Rx+ / Tx+

Send/Receive data cable (positive pole)

GND

Earth cable

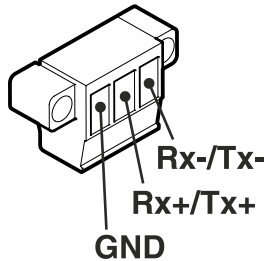

Opening for external temperature sensor

The sensor cable opening is located on the back of the appliance.

- Remove the foam seals from the sensor cable opening.
- Thread the sensor cable through the opening to the inside.
- Connect the sensor cable to the appropriate connector.

The position of the connector is shown in the section entitled **External alarm** > Optional temperature sensor connection.

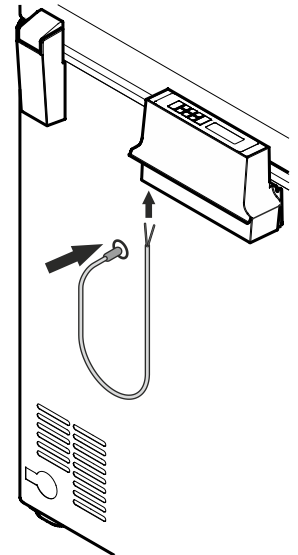

- Place the foam seal over the cable, close it and place it in the opening.
- Complete the same process on the inside of the appliance with the second foam seal.

Important!

Finally, seal the sensor cable opening on the exterior using the grey sealant provided since otherwise icing may occur in this area.

