

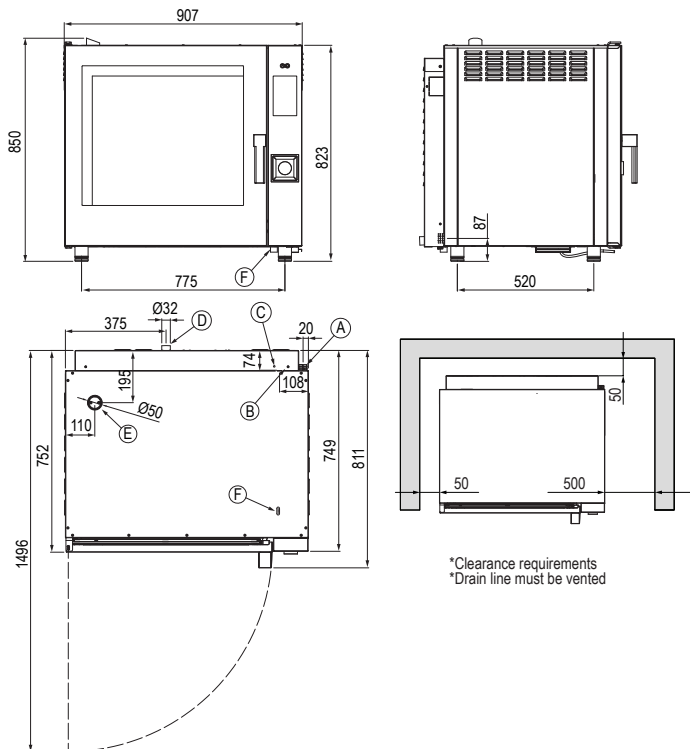

Product Information:

- Highly efficient instant steam injection oven
- Crosswise (left to right tray configuration) for shorter depth
- Controlled humidity in the cooking chamber
- Large 7" innovative touch screen interface
- **One Touch** function for easy, icon controlled cooking
- Over 120 pre-set cooking programs, 1,000+ additional programs - 9 phase memory available
- Automatic, adaptive cooking, rack control, regeneration, sous vide and smoking programs
- Easy Service function and Recipe tuner as standard
- Dual tray slides (1/1GN or 600x400mm) with 74mm clearance for increased airflow
- 2 x 3-speed inverter controlled fans for increased precision, control and reliability
- LED lighting for superior cavity illumination
- USB connection and core probe
- Oven cleaning system with liquid, via intergrated dispenser
- All combi ovens are supplied with either Standard or Reverse Osmosis Filtration system
- 24-month warranty (Terms and conditions apply)

General Drawing:



Specifications:

Model - Standard Filter	MTE7XWLT.SF
Model - Reverse Osmosis	MTE7XWLT.RO
W x D x H (mm)	907 x 811 x 850
Weight	105kg
Capacity	7 x 1/1 GN Pans
Packed Dimensions (mm) / Weight	
Electrical Connection	3Ø + N + E 415VAC / 50Hz / 12.6kW
Cold Water Connection	3/4 BSP 300-350 kpa Min 10°C - Max 35°C
Water Quality Requirements	Hardness 60-100ppm TDS <100mg/L Cl Chloride <32mg/L

Legend:

- A Electrical Connection
- B Steam Generation Water Inlet 3/4" BSP
- C Wash System Water Inlet 3/4" BSP
- D Drain Connection 32mm
- E Humidity Vent
- F Detergent Line Inlet

Heat Source: 500mm clearance from an external heat source is required in order to protect the oven control components and allow access to the service panel. For clearances under 500mm, it is mandatory for Stoddart heat shields to be fitted while still maintaining a minimum clearance of 300mm to provide access to the service compartment. Failure to adhere to minimum clearances may void the oven warranty or add service costs due to lack of access.

Non-Heat Source: Generally 300mm clearance is required from the control panel side to allow access to the service panel. Any distance under 300mm, may add service costs due to lack of access.

Due to continuous product research and development, the information contained herein is subject to change without notice.

Revision: 04 - 09/02/2022 - A

www.stoddart.com.au

www.stoddart.co.nz

