



DYNACO
High Performance Doors



DYNACO M2 FREEZER

Push-Pull
gear driven technology



inside door

DYNACO M2 FREEZER

The Dynaco M2 Freezer is specially designed for freezer applications. High operating speed and excellent seal allow efficient traffic flow while minimizing temperature variations. Optionally, an insulated curtain is available for additional savings on energy costs. The absence of rigid elements in the curtain and the soft bottom edge make the Dynaco M2 Freezer intrinsically safe.

- **HIGH SPEED OPERATION:**
2,4 m/s opening speed.
1,2 m/s closing speed.
- **PATENTED “PUSH PULL” TECHNOLOGY:**
Unique door drive system.
- **SUPERIOR SEAL:**
Patented side frame assembly. Neither blade nor brush systems required.
- **CRASH FORGIVING AND SELF-REINSERTING WITHOUT INTERVENTION:**
The curtain automatically reinserts itself when dislodged. No repair costs, no production down time.
- **USER SAFETY:**
Flexible curtain without rigid elements.
- **COMFORT OF USE:**
DYNACO wireless detector at the bottom.
- **ADVANCED DRIVE:**
Frequency driven motor and encoder for smooth operation. Wearable elements are reduced to a minimum.
- **DYNALOGIC CONTROL BOX:**
User-friendly control box with self-diagnosis.
- **CONFORM TO EN13241-1**

Insulating curtain

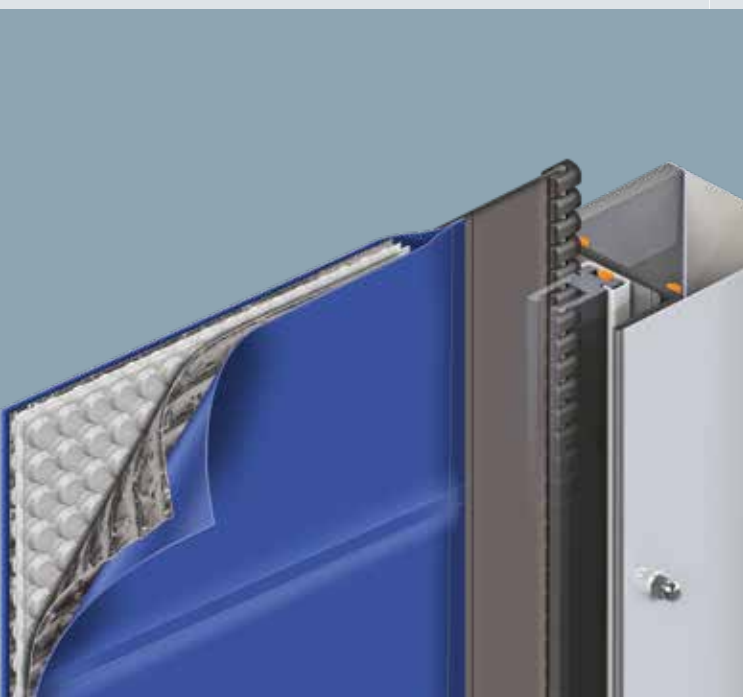

“PUSH-PULL^{PT}” drive technology

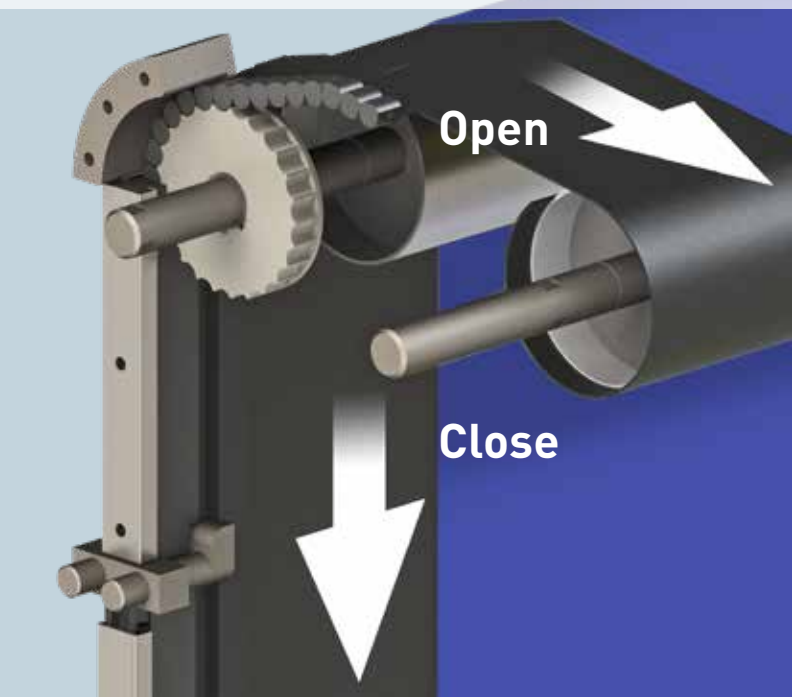



























EN13241-1 STANDARDS

Standard	Ref.	Test acc.	Results
Water permeability	EN 12425	EN 12489	Class 1
Wind load	EN 12424	EN 12444	Class 1
Wind permeability	EN 12426	EN 12427	Class 1*
Safe openings	EN 12453	EN 12445	Pass
Mechanical resistance	EN 12604	EN 12605	Pass
Unintended movements	EN 12604	EN 12605	Pass
Thermal transmittance	EN 12428	EN 12428	6,02 W/m ² K
Performance (cycles)	EN 12604	EN 12605	1.000.000

* Valid for a door of 3500 x 3500mm

CHARACTERISTICS

Max. dimensions	W 4.000 mm x H 5.500 mm																	
Opening speed	With standard curtain Up to 2,4 m/s	With insulating curtain Up to 1,2 m/s																
Closing speed	1,2 m/s	1,2 m/s																
Structure	Galvanised steel: 80 x 40 x 3 mm. Option: stainless steel.																	
Drum	Steel - Ø 102 x 2 mm.																	
Side guides	Reinforced polyethylene (PE-UHMW1000) on springs, heated																	
Motor	4 poles, without brake. Power 1,5 kW IP rating: IP 65																	
Control box	DYNALOGIC provided with: circuit breaker, general divider, adjustable timer, push button for opening and reset and emergency stop. IP rating: IP 54. Frequency inverter.																	
Standard detectors	Infrared barrier: 300 mm from the floor. Wireless DYNACO detector (WDD).																	
Power supply	Single phase 230V - 23 A																	
Frequency	Frequency: 50-60 Hz																	
Advised operating temperature:	- 30°C up to +5°C																	
Available colours comparable with:	<table border="0"> <tr> <td>Yellow RAL1003</td> <td></td> <td>Green RAL6005</td> <td></td> </tr> <tr> <td>Orange RAL2004</td> <td></td> <td>Grey RAL7035</td> <td></td> </tr> <tr> <td>Red RAL3000</td> <td></td> <td>White RAL9010</td> <td></td> </tr> <tr> <td>Blue RAL5002</td> <td></td> <td>Black RAL9005</td> <td></td> </tr> </table>		Yellow RAL1003		Green RAL6005		Orange RAL2004		Grey RAL7035		Red RAL3000		White RAL9010		Blue RAL5002		Black RAL9005	
Yellow RAL1003		Green RAL6005																
Orange RAL2004		Grey RAL7035																
Red RAL3000		White RAL9010																
Blue RAL5002		Black RAL9005																
[Actual colours may deviate. Colour samples available upon request]																		

Side guide and lateral driving strap view

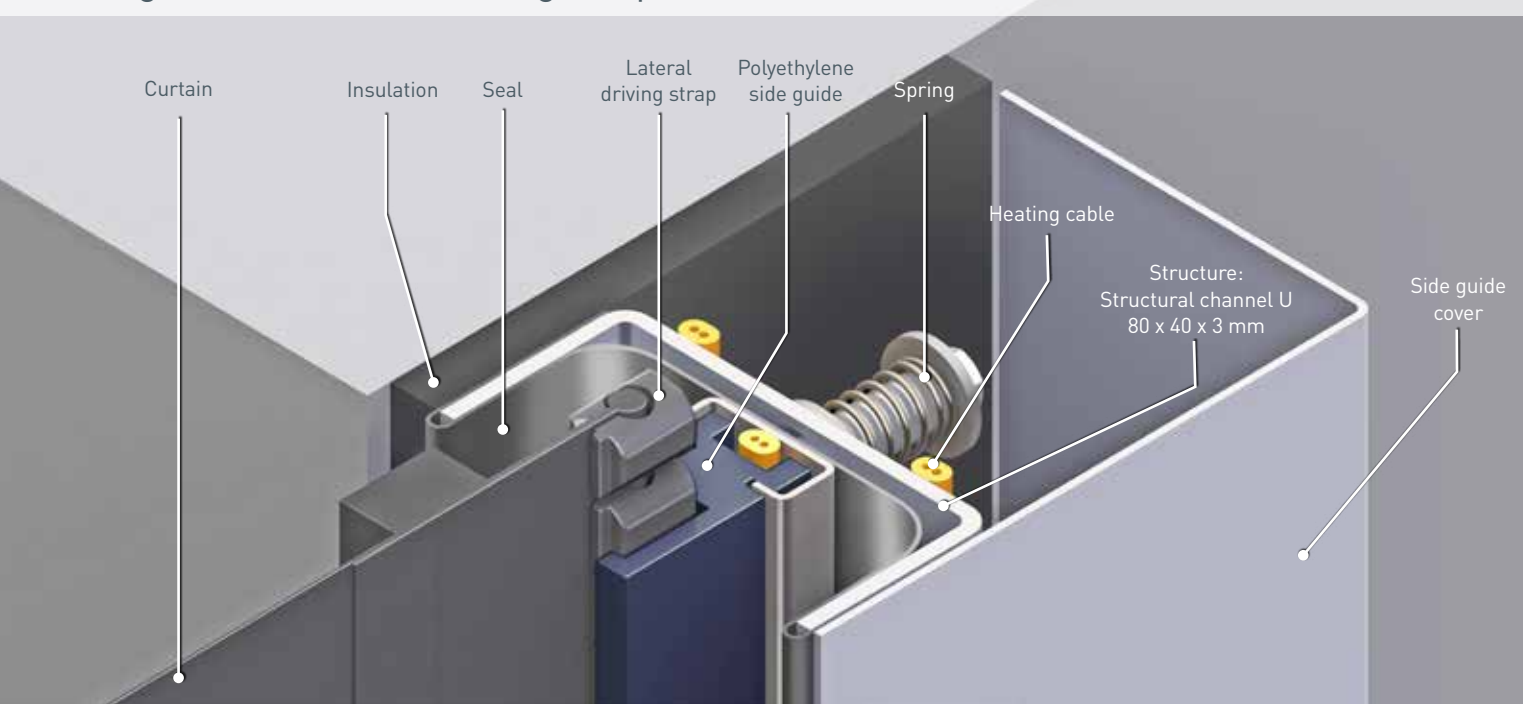

Dimensions and installation requirements Dynaco M2 Freezer

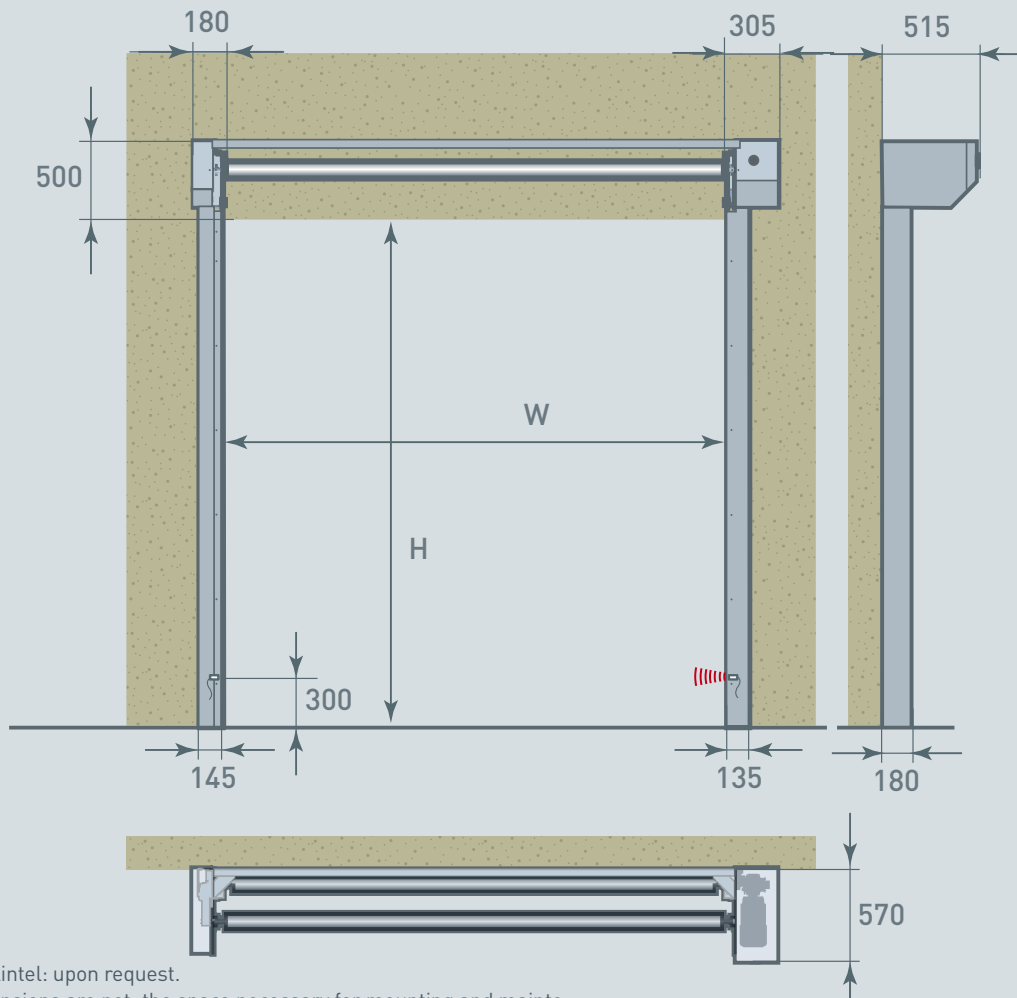

* Option reduced lintel: upon request.

All indicated dimensions are net: the space necessary for mounting and maintenance has to be provided. Weekly maintenance (de-icing) is necessary.

REMARK: Based on the risk analysis of the environment, extra push buttons and detectors might be required.



ENTREMATIc BELGIUM NV
 Waverstraat 21
 B-9310 Moorsel-Aalst (Belgium)
 Tel. +32 53 72 98 98
 Fax. +32 53 72 98 50
 info.dynaco.eu@entrematic.com
 www.dynacodoor.com

About Dynaco

Founded in 1987, the Dynaco brand has a strong heritage and a wealth of expertise in high performance doors. Dynaco is committed to achieving excellence in quality and performance through a certified and dedicated network of partners, providing outstanding service to customers worldwide. Furthermore we trust our USA division and our licensed partners in Russia, Japan, China, Vietnam and Brazil to deliver on our customer promises. Dynaco is part of Entrematic—the home to some of the world's most innovative and leading brands within the entrance automation industry. The comprehensive range of product brands includes Ditec, Normstahl and em/Entrematic.