

Model: LE40XZSF25DNOY-D

Features

Long sensing distance, stable performance, suitable for double and triple distance detection.

Technical Specifications

Mounting	Quasi-flush	Hysteresis range	1...20%
Sensing distance	25mm	Repeat accuracy	≤3%
Assured Distance	0...20mm	Ambient temperature	-25°C...70°C
Standard target	Fe 75*75*1t	Ambient Humidity	35-95%RH
Rectangular size	40*40*140mm	Circuit protection	Short circuit protection, overload protection, reverse polarity protection
Output ways	NPN	Withstand voltage	1000V/AC 50/60Hz 60s
Output status	NO	Insulation resistance	≥50MΩ (500VDC)
Residual voltage	≤2.5V	Vibration resistance	Complex amplitude 1.5mm 10...50Hz(X,Y,Z 2 hours at each direction)
Supply voltage	10...30VDC	Protection degree	IP67
Load current	≤200mA	Output indicator	Yellow LED
Current consumption	≤10mA	Housing Material	PBT
Switching frequency	200Hz	Connection Type	Terminal
Assured distance	≤±10%	Certification	CE

Dimensions

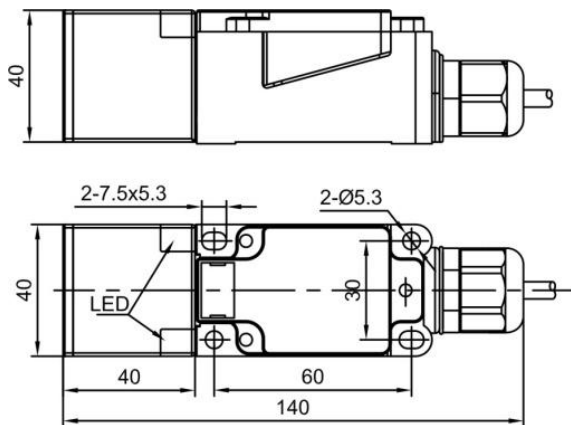

Wiring Diagram

