

VARI-CART

1000 SERIES

VARI-CART

1000 SERIES



*Model shown 3200.6



FREEWAY
Medical

Varied in name, varied in use...

But this time, it's twice as wide for extra storage needs! Double the capacity than the single width 500 series design, the 1000 Series Vari-Cart offers the same high-quality, durable finish and simple modular construction that enables such variety of uses.

Longevity is key, with tool-less parts to make maintenance easier and extend product life without needing to replace entirely. Customisation is included in cost price with options to pick from 8 frame colours and options of storage tray types.

Explore our 1000 Series Vari-Cart range >

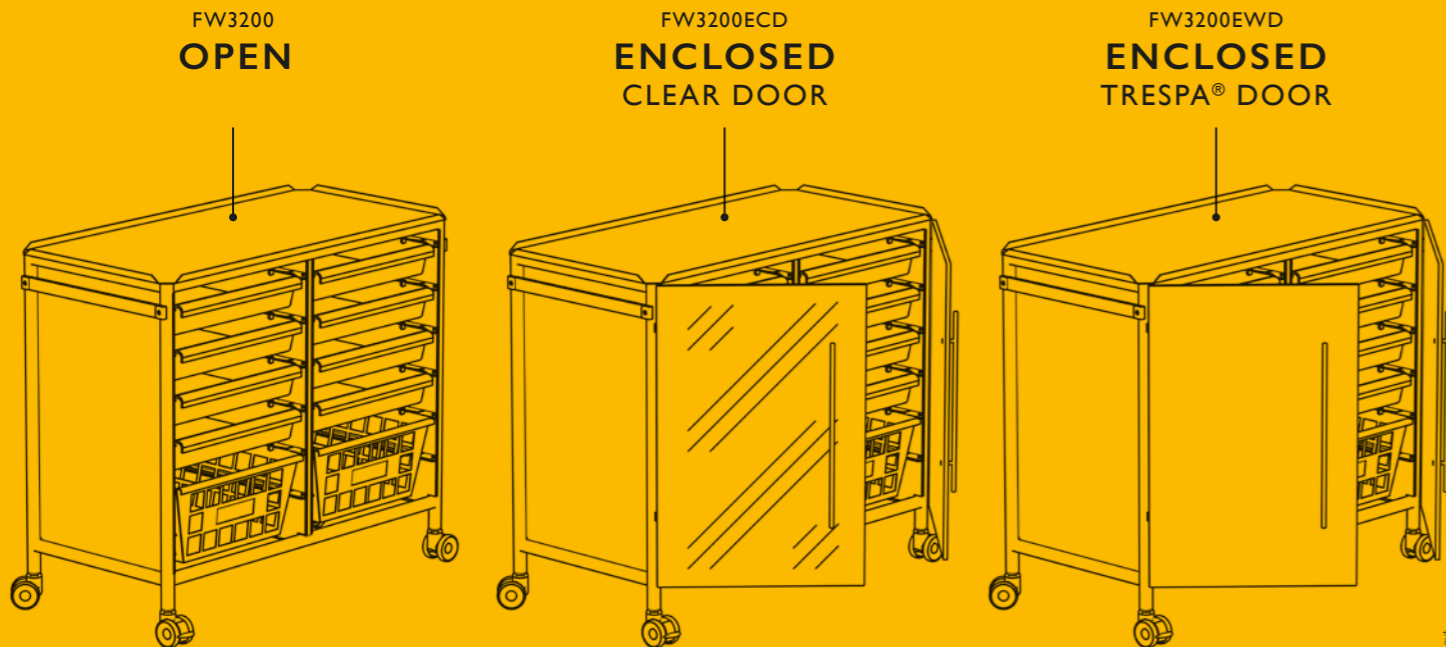

*3200-6 model shown throughout

○ **What is included on the base models?**

The base models for our double width 1000 Series Vari-Cart range have multiple options, including height, colour of frame and storage tray combinations, which come as standard so you can customise your cart at no extra cost.

If you would like to upgrade components or add optional extras, there are also plenty to choose from so the cart you get, is the cart that you want.

**1. CHOOSE YOUR
IDEAL HEIGHT**
(8 available)



**2. CHOOSE YOUR
FRAME COLOUR**
(8 available)

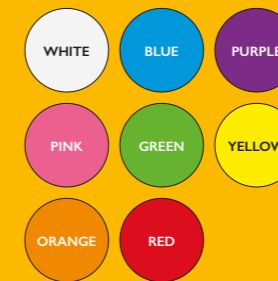

**3. CHOOSE YOUR
STORAGE TRAYS**
(in any combination)

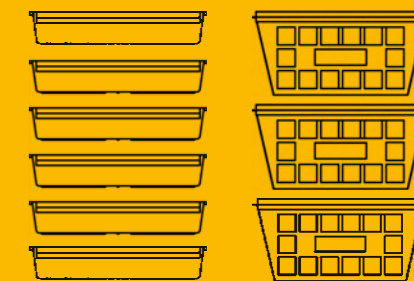

4. CHOOSE YOUR HOOK-OVER ACCESSORIES* (optional, see pages 22-25)

It's simple: choose the height that is the best fit for your requirements!

SELECTING THE RIGHT HEIGHT...

The vast choice of frame heights gives endless tray configurations and the ability to maximise the storage capacity within any given space, especially with the storage available in the double width 1000 series Vari-Cart.

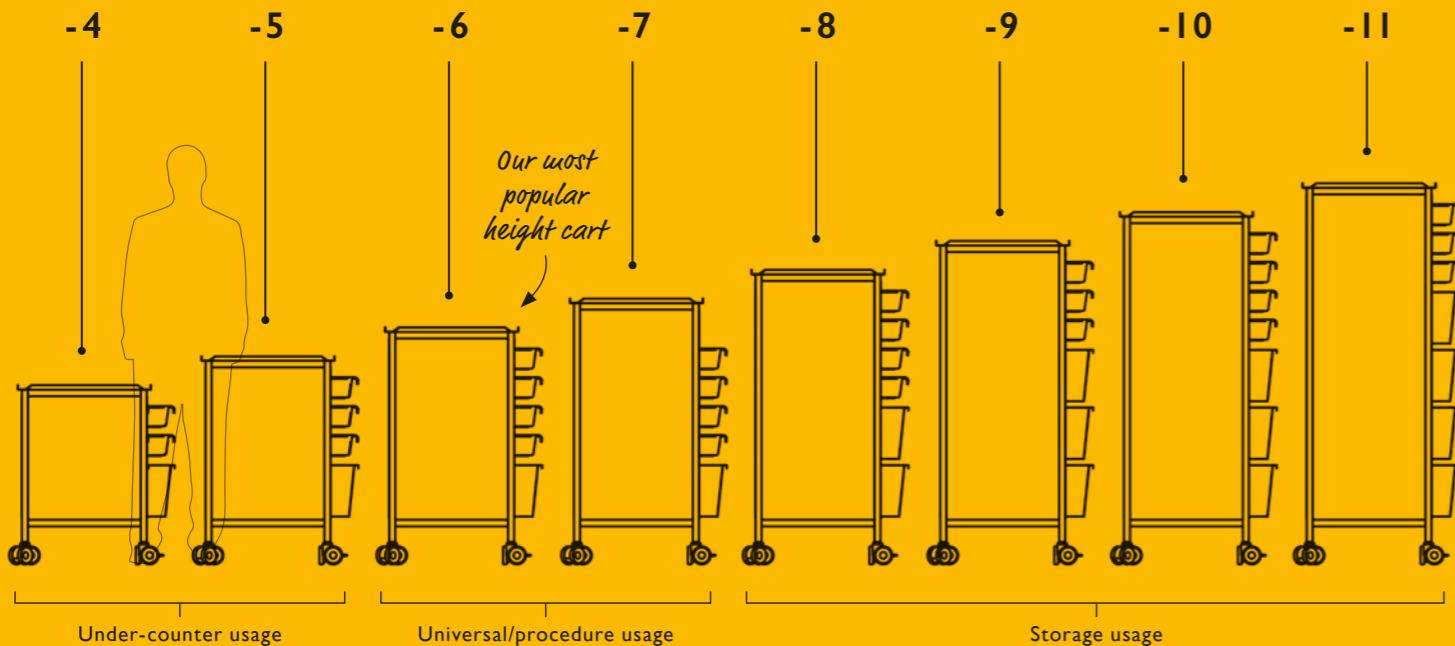

VARI-CART 1000 SERIES MODEL FINDER

OPEN

PRODUCT CODE	HEIGHT (MM)	PAGE
FW3200-4	710	86
FW3200-5	815	87
FW3200-6	920	88
FW3200-7	1025	89
FW3200-8	1130	90
FW3200-9	1235	91
FW3200-10	1340	92
FW3200-11	1445	93

ENCLOSED CLEAR DOOR

PRODUCT CODE	HEIGHT (MM)	PAGE
FW3200 ECD-4	710	96
FW3200 ECD-5	815	98
FW3200 ECD-6	920	100
FW3200 ECD-7	1025	102
FW3200 ECD-8	1130	104
FW3200 ECD-9	1235	106
FW3200 ECD-10	1340	108
FW3200 ECD-11	1445	110

ENCLOSED TRESPA® DOOR

PRODUCT CODE	HEIGHT (MM)	PAGE
FW3200 EWD-4	710	97
FW3200 EWD-5	815	99
FW3200 EWD-6	920	101
FW3200 EWD-7	1025	103
FW3200 EWD-8	1130	105
FW3200 EWD-9	1235	107
FW3200 EWD-10	1340	109
FW3200 ECD-11	1445	111



1000 SERIES VARI-CART OPEN

- Open front and back
- 2 medical rails
- 8 frame colours available
- Any tray combination
- 4 ultra durable castors/2 brakes
- Upgradeable worktop

Simple modular construction - the Vari-Cart's greatest asset.

The double width 1000 series Vari-Cart Open, despite being twice the size of the 500 series, is still just as simple to disassemble. Sharing the same modular construction principles, the 1000 series Vari-Cart parts can be removed with just 4 thumbscrews.



The ability to carry out deep routine cleaning and replace parts eliminates the need to buy an entire new product for one defect.

VARI-CART OPEN - 1000 SERIES / 2 x 4 TRAY SPACE



PRODUCT CODE
FW3200-4 Open Vari-Cart 1000 Series

The double width Open Vari-Cart has twice the space the single width Vari-Cart offers, allowing more storage and transportation options for medicine, equipment or notes. Hospitals find having the extra manoeuvrable storage invaluable, especially with the open front and back access for ease and simplicity.

DIMENSIONS
Height = 710mm Width = 1030mm Depth = 540mm

PRODUCT ELEVATIONS

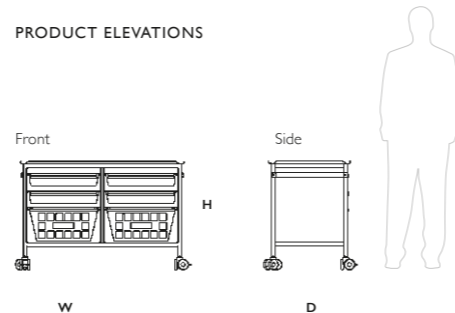

FRAME/WORKTOP COLOURS *(included in price)*

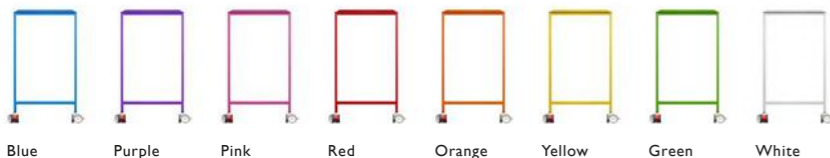

Blue Purple Pink Red Orange Yellow Green White

STORAGE TRAY CHOICE *(included in price)*

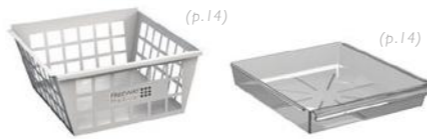

Double-space metal basket Single-space acrylic tray

VARI-CART OPEN - 1000 SERIES / 2 x 5 TRAY SPACE



PRODUCT CODE
FW3200-5 Open Vari-Cart 1000 Series

With all the extra room, you can personalise your tray options even further: Chop and change your combination of double-space metal baskets for when you need a deeper storage option of 200mm, or our single-space acrylic tray (100mm) for extra flexibility within the double width Open Vari-Cart.

DIMENSIONS
Height = 815mm Width = 1030mm Depth = 540mm

PRODUCT ELEVATIONS

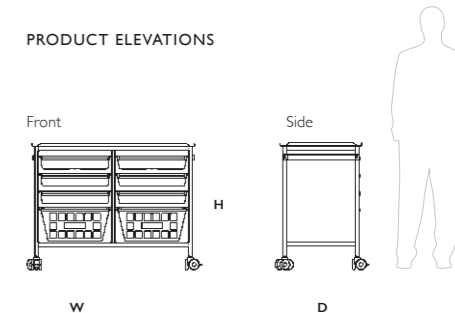

WORKTOP UPGRADES



Ultra durable Trespa® Stainless steel (capped edge)

HOOK-OVER ACCESSORIES *(optional)*



*Consumables not included.

STORAGE COMBINATIONS *(included in price)*



VARI-CART OPEN - 1000 SERIES / 2 x 6 TRAY SPACE



PRODUCT CODE
FW3200-6 Open Vari-Cart 1000 Series

The quality of our double width Open Vari-Cart is in line with the exacting standards which all our components are manufactured to. With Freeway Medical you can be reassured every product, 6 tray space or any other, will endure the test of time and satisfaction whilst being flexible to your evolving needs.

DIMENSIONS
Height = 920mm Width = 1030mm Depth = 540mm

PRODUCT ELEVATIONS

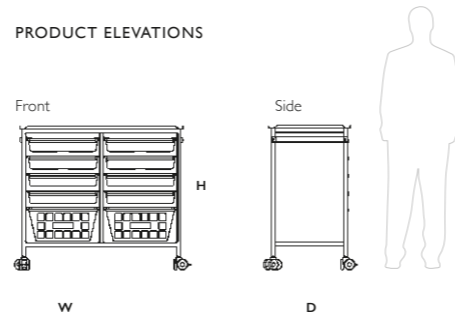

FRAME/WORKTOP COLOURS *(included in price)*

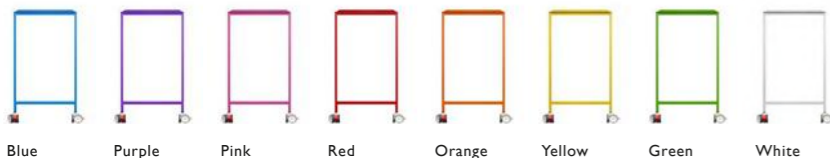

Blue Purple Pink Red Orange Yellow Green White

STORAGE TRAY CHOICE *(included in price)*

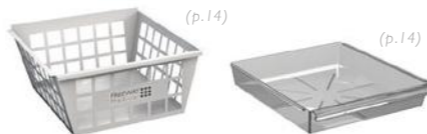

Double-space metal basket Single-space acrylic tray

VARI-CART OPEN - 1000 SERIES / 2 x 7 TRAY SPACE



PRODUCT CODE
FW3200-7 Open Vari-Cart 1000 Series

Live up your ward with a pink hue, welcome the outside in with a calming green or even keep it fresh with a crisp white; included as standard, you can choose your worktop and frame colour to organise, identify and complement the colours of whichever room you choose.

DIMENSIONS
Height = 1025mm Width = 1030mm Depth = 540mm

PRODUCT ELEVATIONS

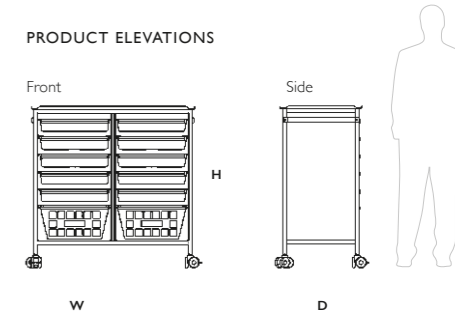

WORKTOP UPGRADES



Ultra durable Trespa® Stainless steel (capped edge)

HOOK-OVER ACCESSORIES *(optional)*



(p.22)
*Consumables not included.

STORAGE COMBINATIONS *(included in price)*



VARI-CART OPEN - 1000 SERIES / 2 x 8 TRAY SPACE



PRODUCT CODE
FW3200-8 Open Vari-Cart 1000 Series

The double width Open Vari-Cart has double medical rails too to transform the use of the cart that are just as useful for hanging up aprons as they are for adding crucial accessories like IV pole holders. Pick from our range of excellent accessories for maximum flexibility of your Vari-Cart use.

DIMENSIONS
Height = 1130mm Width = 1030mm Depth = 540mm

PRODUCT ELEVATIONS

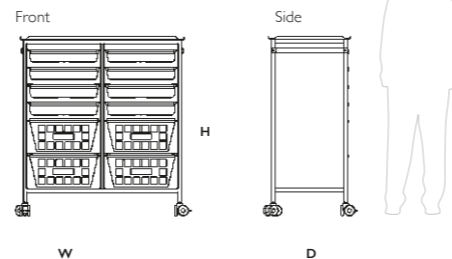

FRAME/WORKTOP COLOURS *(included in price)*

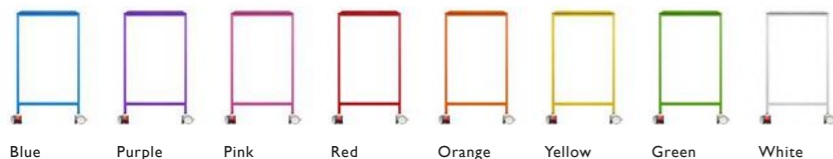

Blue Purple Pink Red Orange Yellow Green White

STORAGE TRAY CHOICE *(included in price)*

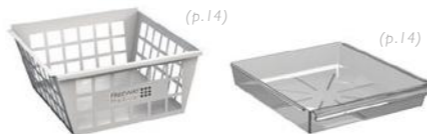

Double-space metal basket Single-space acrylic tray

VARI-CART OPEN - 1000 SERIES / 2 x 9 TRAY SPACE



PRODUCT CODE
FW3200-9 Open Vari-Cart 1000 Series

A unique construction process from Freeway Medical has been designed to make even the double width Open Vari-Cart simple to construct, conduct routine or deep-cleaning or replace any parts. Parts are easily removed by thumbscrews without needing tools or prior experience.

DIMENSIONS
Height = 1235mm Width = 1030mm Depth = 540mm

PRODUCT ELEVATIONS

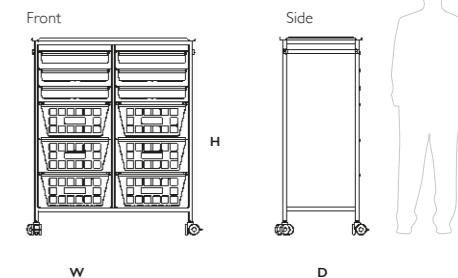

WORKTOP UPGRADES

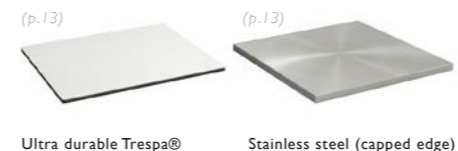

Ultra durable Trespa® Stainless steel (capped edge)

HOOK-OVER ACCESSORIES *(optional)*



(p.22)
*Consumables not included.

STORAGE COMBINATIONS *(included in price)*



Clear trays Metal baskets Or a mix of both!

VARI-CART OPEN - 1000 SERIES / 2 x 10 TRAY SPACE



PRODUCT CODE
FW3200-10 Open Vari-Cart 1000 Series

Freeway Medical offers a complete custom design service for all ranges to ensure you get the right product. The possibilities are vast; modify an existing cart or opt for a totally customised product. It starts with a conversation and results in the perfect product which both lasts and impresses.

DIMENSIONS
Height = 1340mm Width = 1030mm Depth = 540mm

PRODUCT ELEVATIONS

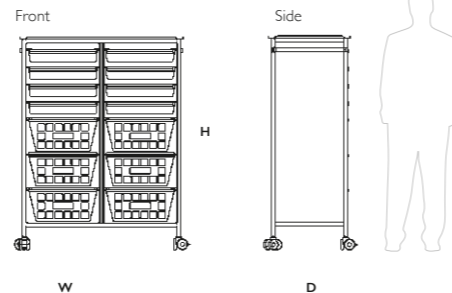

FRAME/WORKTOP COLOURS *(included in price)*

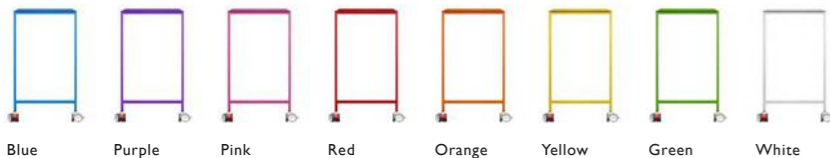

Blue Purple Pink Red Orange Yellow Green White

STORAGE TRAY CHOICE *(included in price)*

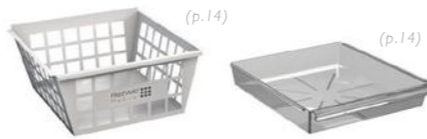

Double-space metal basket Single-space acrylic tray

VARI-CART OPEN - 1000 SERIES / 2 x 11 TRAY SPACE



MEDICAL
RAIL
AS STANDARD

PRODUCT CODE
FW3200-11 Open Vari-Cart 1000 Series

Our largest double width Open Vari-Cart offers the most space, with premium design features that come as standard, like smooth and durable triple-bearing castors in the wheel and axles for effortless manoeuvring.

DIMENSIONS
Height = 1445mm Width = 1030mm Depth = 540mm

PRODUCT ELEVATIONS

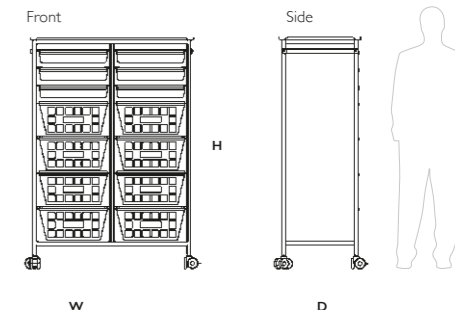

WORKTOP UPGRADES

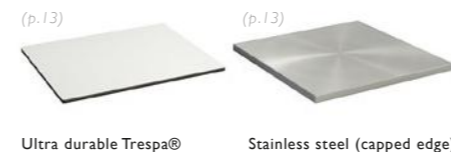

Ultra durable Trespa® Stainless steel (capped edge)

HOOK-OVER ACCESSORIES *(optional)*



(p.22)
*Consumables not included.

STORAGE COMBINATIONS *(included in price)*





1000 SERIES VARI-CART ENCLOSED

- Clear acrylic or solid Trespa® door
- Sealed rear panel
- Digital locking/anti-tamper options
- 8 frame colours available
- Any tray combination
- 4 ultra durable castors/2 brakes
- Upgradeable worktop

Simple modular construction - the Vari-Cart's greatest asset.

The double width Vari-Cart Enclosed has been meticulously designed by Freeway Medical to offer ease and genuine simplicity on hospital wards, incorporating toolless construction and disassemble, with just 4 thumbscrews.



Tools are not required nor is previous experience, so everyone can take advantage of the modular construction of the cart.

VARI-CART ENCLOSED (CLEAR DOOR) - 1000 SERIES / 2 x 4 TRAY SPACE



SEALED
REAR
PANEL

PRODUCT CODE
FW3200 ECD-4 Enclosed Vari-Cart 1000 Series

The double width Enclosed Vari-Cart with a clear acrylic door ensures medicine, equipment and more can be protected and secure wherever it goes, whilst remaining in view for ease and speed. The 4 tray Enclosed Vari-Cart fits neatly under counters out of the way, storing all you need in a convenient and transportable option.

DIMENSIONS
Height = 710mm Width = 1030mm Depth = 540mm

PRODUCT ELEVATIONS (Clear and Trespa®)

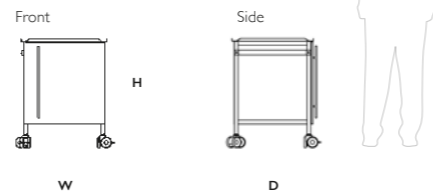

FRAME/WORKTOP COLOURS (included in price)



Blue Purple Pink Red Orange Yellow Green White

STORAGE TRAY CHOICE (included in price)

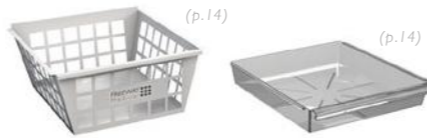

Double-space metal basket Single-space acrylic tray

VARI-CART ENCLOSED (TRESPA® DOOR) - 1000 SERIES / 2 x 4 TRAY SPACE



DOOR
270°
OPENS

PRODUCT CODE
FW3200 EWD-4 Enclosed Vari-Cart 1000 Series

Opting for a solid white Trespa® door offers discreet, subtle and secure storage and transportation in the double width Enclosed Vari-Cart range. The opaque choice of door on this piece of equipment guarantees peace of mind whilst in and around hospital wards, tending to patients, carrying out routine procedures or whilst stationary.

STORAGE COMBINATIONS (included in price)



WORKTOP UPGRADES



Ultra durable Trespa® Stainless steel (capped edge)

DIGITAL LOCK OPTION

Keyless everyday operation with master key for maintenance or forgotten codes.



(p.18)

ANTI-TAMPER OPTION

A simple solution for preventing and identifying loss or theft of stock with a one-time use plastic tie.



(p.19)

VARI-CART ENCLOSED (CLEAR DOOR) - 1000 SERIES / 2 x 5 TRAY SPACE



DOOR
270°
OPENS

PRODUCT CODE

FW3200 ECD-5 Enclosed Vari-Cart 1000 Series

A 270° clear acrylic door opening on this double width Enclosed Vari-Cart allows for easy access to the contents. The wide opening is just one of many design features included, customised for the end user. Little things really do make a difference, which is why we focus on all the details, big and small.

DIMENSIONS

Height = 815mm Width = 1030mm Depth = 540mm

PRODUCT ELEVATIONS (Clear and Trespa®)

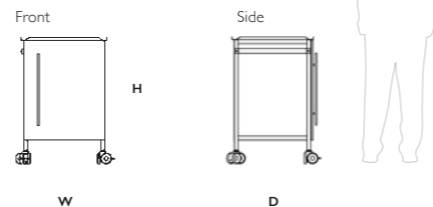

FRAME/WORKTOP COLOURS (included in price)



Blue Purple Pink Red Orange Yellow Green White

STORAGE TRAY CHOICE (included in price)

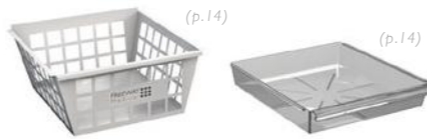

Double-space metal basket Single-space acrylic tray

VARI-CART ENCLOSED (TRESPA® DOOR) - 1000 SERIES / 2 x 5 TRAY SPACE



PRODUCT CODE

FW3200 EWD-5 Enclosed Vari-Cart 1000 Series

Freeway Medical offers you the choice of 8 available colours for your frame and worksurface to set off the crisp white of a Trespa® door. These colours, ranging from blue to orange, pink and green and more, give the opportunity to colour code your ward to distinguish, identify and organise equipment accordingly.

STORAGE COMBINATIONS (included in price)



WORKTOP UPGRADES



Ultra durable Trespa® Stainless steel (capped edge)

DIGITAL LOCK OPTION

Keyless everyday operation with master key for maintenance or forgotten codes.



ANTI-TAMPER OPTION

A simple solution for preventing and identifying loss or theft of stock with a one-time use plastic tie.



VARI-CART ENCLOSED (CLEAR DOOR) - 1000 SERIES / 2 x 6 TRAY SPACE



PRODUCT CODE

FW3200 ECD-6 Enclosed Vari-Cart 1000 Series

The double width Enclosed Vari-Cart with a clear acrylic door can be used both as an excellent storage and transportation unit as well as an extra durable workspace for you to utilise. Upgrades are available for increased longevity and you can choose between a capped edge or a raised-lip edge, dependent on your needs.

DIMENSIONS

Height = 920mm Width = 1030mm Depth = 540mm

PRODUCT ELEVATIONS (Clear and Trespa®)

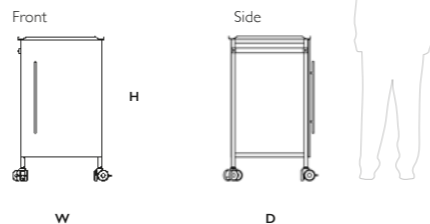

FRAME/WORKTOP COLOURS (included in price)



Blue Purple Pink Red Orange Yellow Green White

STORAGE TRAY CHOICE (included in price)

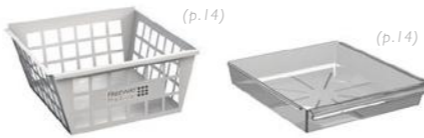

Double-space metal basket Single-space acrylic tray

VARI-CART ENCLOSED (TRESPA® DOOR) - 1000 SERIES / 2 x 6 TRAY SPACE



PRODUCT CODE

FW3200 EWD-6 Enclosed Vari-Cart 1000 Series

Whether you are looking for a single piece of equipment or an entire hospital refit, the various ranges we offer ensure you get the right fit. Our 6 tray space double width Enclosed Vari-Cart is our most popular height for universal or procedural use, the ideal size to utilise the workstation as well as the storage secured by a solid Trespa® door.

STORAGE COMBINATIONS (included in price)



WORKTOP UPGRADES



Ultra durable Trespa® Stainless steel (capped edge)

DIGITAL LOCK OPTION

Keyless everyday operation with master key for maintenance or forgotten codes.



(p.18)

ANTI-TAMPER OPTION

A simple solution for preventing and identifying loss or theft of stock with a one-time use plastic tie.



(p.19)

VARI-CART ENCLOSED (CLEAR DOOR) - 1000 SERIES / 2 x 7 TRAY SPACE



PRODUCT CODE
FW3200 ECD-7 Enclosed Vari-Cart 1000 Series

The double width Enclosed Vari-Cart with a clear acrylic door is beautifully simple, with our specialist modular construction process designed with you in mind. Parts are easily transplanted and removed without tools or prior experience making cleaning, replacements and upgrades straightforward for all.

DIMENSIONS
Height = 1025mm Width = 1030mm Depth = 540mm

PRODUCT ELEVATIONS (Clear and Trespa®)

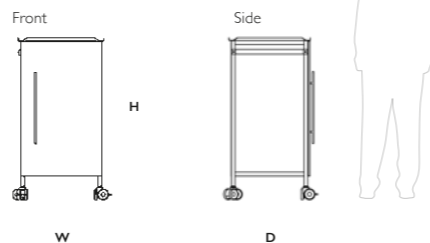

FRAME/WORKTOP COLOURS (included in price)

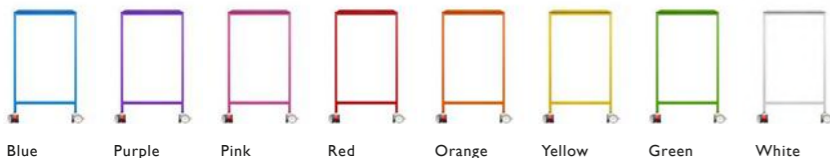

STORAGE TRAY CHOICE (included in price)

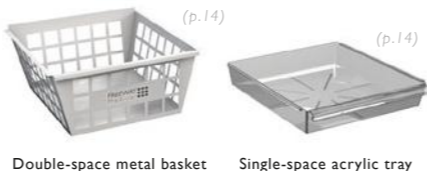

VARI-CART ENCLOSED (TRESPA® DOOR) - 1000 SERIES / 2 x 7 TRAY SPACE



PRODUCT CODE
FW3200 EWD-7 Enclosed Vari-Cart 1000 Series

Guaranteed with a solid Trespa® door is secure and concealed storage, made possible with a sealed rear panel on every one of our Enclosed Vari-Cart range. The rear panel is fitted to ensure only authorised access via the doors at the front of the cart, meaning one less thing to worry about when it comes to your rounds.

STORAGE COMBINATIONS (included in price)



WORKTOP UPGRADES

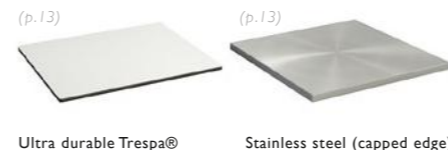

DIGITAL LOCK OPTION

Keyless everyday operation with master key for maintenance or forgotten codes.



ANTI-TAMPER OPTION

A simple solution for preventing and identifying loss or theft of stock with a one-time use plastic tie.



VARI-CART ENCLOSED (CLEAR DOOR) - 1000 SERIES / 2 x 8 TRAY SPACE



PRODUCT CODE
FW3200 ECD-8 Enclosed Vari-Cart 1000 Series

A clear acrylic door means you can admire your choice of storage tray combinations even when the door is closed! With two available types of storage trays, a double-space metal basket (200mm) or a single-space acrylic tray (100mm), arrange your double width Enclosed Vari-Cart how you want to suit your requirements.

DIMENSIONS
Height = 1130mm Width = 1030mm Depth = 540mm

PRODUCT ELEVATIONS (Clear and Trespa®)

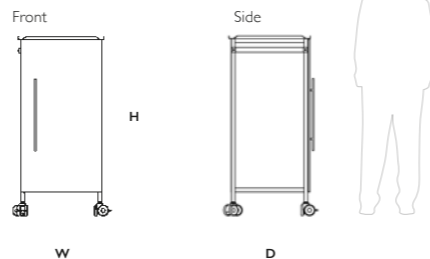

FRAME/WORKTOP COLOURS (included in price)



Blue Purple Pink Red Orange Yellow Green White

STORAGE TRAY CHOICE (included in price)

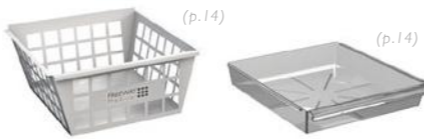

Double-space metal basket Single-space acrylic tray

VARI-CART ENCLOSED (TRESPA® DOOR) - 1000 SERIES / 2 x 8 TRAY SPACE



PRODUCT CODE
FW3200 EWD-8 Enclosed Vari-Cart 1000 Series

Your choice of storage tray combinations doesn't stop at a deeper basket or clear tray. Each option can be divided further into smaller, organised compartments by simply adding our metal divider set, available as an optional part. Never before has it been so easy for organisation and simplicity in a sleek design with a secure Trespa® door.

DOOR
270°
OPENS

WITH
TRESPA®
DOOR

STORAGE COMBINATIONS (included in price)



WORKTOP UPGRADES



Ultra durable Trespa® Stainless steel (capped edge)

DIGITAL LOCK OPTION

Keyless everyday operation with master key for maintenance or forgotten codes.



ANTI-TAMPER OPTION

A simple solution for preventing and identifying loss or theft of stock with a one-time use plastic tie.



VARI-CART ENCLOSED (CLEAR DOOR) - 1000 SERIES / 2 x 9 TRAY SPACE



DOOR
270°
OPENS

PRODUCT CODE

FW3200 ECD-9 Enclosed Vari-Cart 1000 Series

Every inch of the double width Enclosed Vari-Cart, with a clear acrylic door; from the floor up has been meticulously designed and painstakingly built with care. Starting with the foundations of the cart, the high-quality bearing sets in the wheels and upright axles ensure the effortless manoeuvring of even the most fully stocked cart.

DIMENSIONS

Height = 1235mm Width = 1030mm Depth = 540mm

PRODUCT ELEVATIONS (Clear and Trespa®)

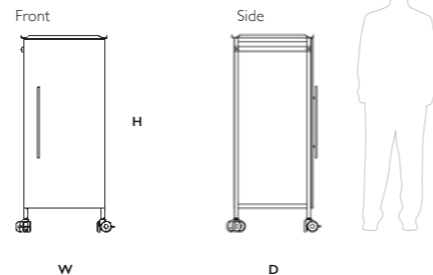

FRAME/WORKTOP COLOURS (included in price)



Blue Purple Pink Red Orange Yellow Green White

STORAGE TRAY CHOICE (included in price)

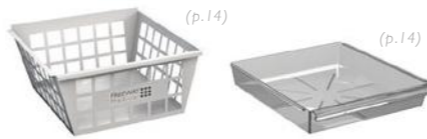

Double-space metal basket Single-space acrylic tray

VARI-CART ENCLOSED (TRESPA® DOOR) - 1000 SERIES / 2 x 9 TRAY SPACE

FREEWAY
Medical



PRODUCT CODE

FW3200 EWD-9 Enclosed Vari-Cart 1000 Series

Available with the option of a brake to firmly secure it in place, the ultra-grip on the tyres ensures maximum traction around the hospital. Safety is paramount and the soft-touch tyres coupled with the triple bearing castors make sure your job transporting this Vari-Cart, with a Trespa® door, around wards is as easy as possible.

STORAGE COMBINATIONS (included in price)



WORKTOP UPGRADES



Ultra durable Trespa® Stainless steel (capped edge)

DIGITAL LOCK OPTION

Keyless everyday operation with master key for maintenance or forgotten codes.



ANTI-TAMPER OPTION

A simple solution for preventing and identifying loss or theft of stock with a one-time use plastic tie.



VARI-CART ENCLOSED (CLEAR DOOR) - 1000 SERIES / 2 x 10 TRAY SPACE



PRODUCT CODE
FW3200 ECD-10 Enclosed Vari-Cart 1000 Series

An acrylic door on this double width Enclosed Vari-Cart, though transparent, is still incredibly secure. The doors can be fitted with a further security measure of an anti-tamper option to ensure even visible contents are safe and you can do your job with peace of mind.

DIMENSIONS
Height = 1340mm Width = 1030mm Depth = 540mm

PRODUCT ELEVATIONS (Clear and Trespa®)

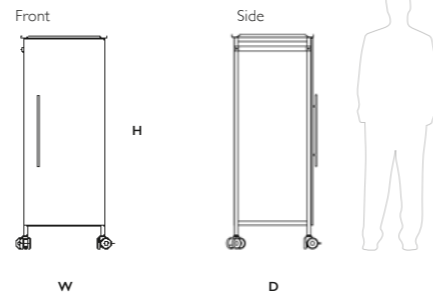

FRAME/WORKTOP COLOURS (included in price)

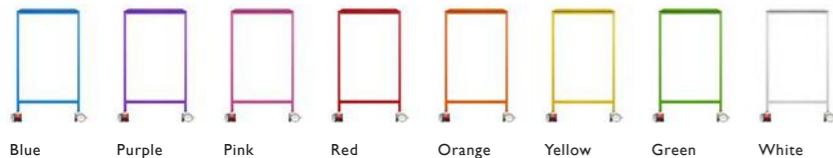

Blue Purple Pink Red Orange Yellow Green White

STORAGE TRAY CHOICE (included in price)

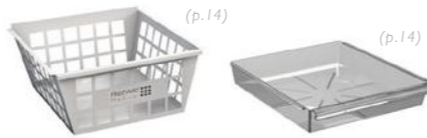

Double-space metal basket Single-space acrylic tray

VARI-CART ENCLOSED (TRESPA® DOOR) - 1000 SERIES / 2 x 10 TRAY SPACE



DOOR
270°
OPENS

PRODUCT CODE
FW3200 EWD-10 Enclosed Vari-Cart 1000 Series

Conceal with a solid Trespa® door and enhance security for sensitive stock with a digital, keyless locking system for extra confidence in the everyday use of the Enclosed Vari-Cart range. A master key is provided for maintenance and for collateral if the codes are forgotten and an override combination is required.

STORAGE COMBINATIONS (included in price)



WORKTOP UPGRADES



Ultra durable Trespa® Stainless steel (capped edge)

DIGITAL LOCK OPTION

Keyless everyday operation with master key for maintenance or forgotten codes.



ANTI-TAMPER OPTION

A simple solution for preventing and identifying loss or theft of stock with a one-time use plastic tie.



VARI-CART ENCLOSED (CLEAR DOOR) - 1000 SERIES / 2 x 11 TRAY SPACE



PRODUCT CODE
FW3200 ECD-II Enclosed Vari-Cart 1000 Series

A clear door, a solid door, basket or tray, 4 tray space double width, 11 tray space double width... the possibilities for customisation are endless. You are just a phone call or meeting away from your ideal piece of equipment, be it bespoke, made from the ground up or modifying an existing product.

DIMENSIONS
Height = 1445mm Width = 1030mm Depth = 540mm

PRODUCT ELEVATIONS (Clear and Trespa®)

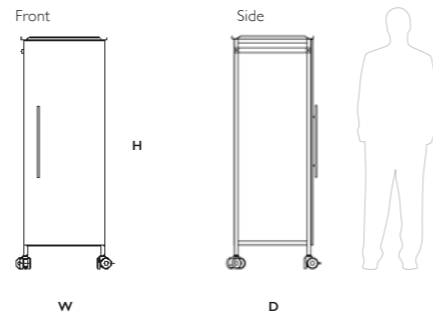

STORAGE TRAY CHOICE (included in price)

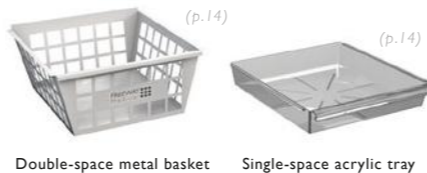

FRAME/WORKTOP COLOURS (included in price)

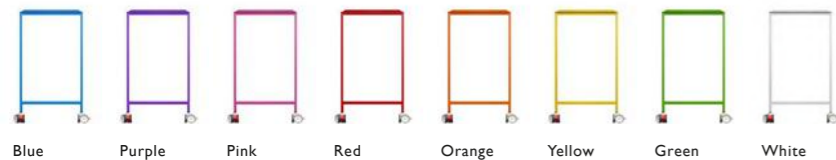

VARI-CART ENCLOSED (TRESPA® DOOR) - 1000 SERIES / 2 x 11 TRAY SPACE

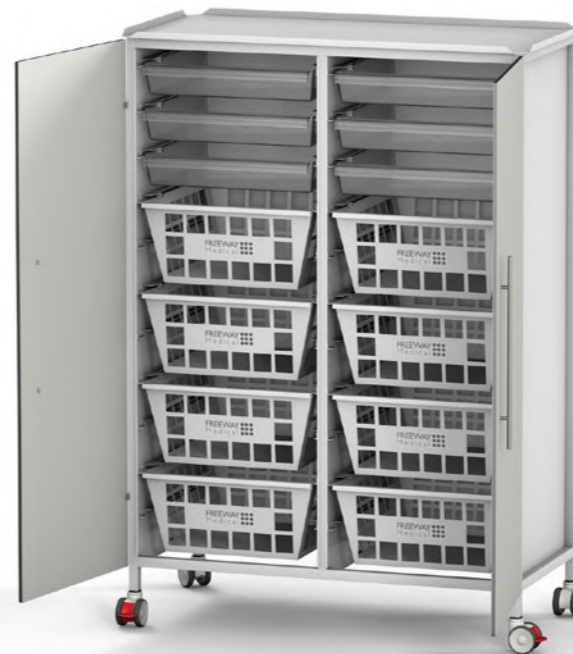

DOOR
270°
OPENS

PRODUCT CODE
FW3200 EWD-II Enclosed Vari-Cart 1000 Series

This double width Enclosed Vari-Cart with a Trespa® door is the largest model in this range with 22 available spaces across the cart for abundant secure and subtle storage for medicine, equipment or notes. Find your perfect size for your requirements and take your pick from metal baskets, acrylic trays or any combination of both.

STORAGE COMBINATIONS (included in price)



WORKTOP UPGRADES

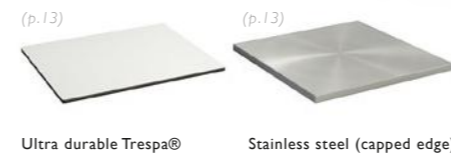

DIGITAL LOCK OPTION

Keyless everyday operation with master key for maintenance or forgotten codes.



ANTI-TAMPER OPTION

A simple solution for preventing and identifying loss or theft of stock with a one-time use plastic tie.



Freeway Medical

Unit 15-16,
Colthrop Business Park,
Colthrop Lane, Thatcham,
Berkshire, RG19 4NB.

Tel: 01635 866 717

Fax: 01635 866 347

Web: freewaymedical.co.uk

Email: sales@freewaymedical.co.uk