



ICE VISION ION

MOON



SOLUZIONI D'ARREDO PER FOOD & BEVERAGE

Il freddo e' il nostro habitat

MOON



Moon



Gelato

IT

Vetrina gelato dall'impronta estetica unica e lunare, adatta a qualsiasi ambiente, con ampia visibilità del prodotto esposto.

Scocca monoblocco con isolamento in poliuretano spessore mm 60, vasca in acciaio inox AISI 304.

Illuminazione a LED.

Alzata vetri riscaldati anticondensa, apertura del vetro frontale a compasso, chiusura lato servizio con scorrevoli in plexiglass.

Refrigerazione ventilata con due evaporatori con doppio flusso dell'aria.

Doppio compressore ermetico (nei modelli 18 e 24) per ottime prestazioni frigo, con basso livello di rumorosità. Optional compressore 400/3.

Unità condensatrice estraibile per una manutenzione semplice e veloce.

Sbrinamento automatico ultrarapido, ad inversione di ciclo.

Quadro comandi elettronico per la regolazione della temperatura.

classe climatica 7 (35°/ 75% UR).

EN

Unique, moon-inspired ice-cream display case design, suitable for any environment and with ample showcase product visibility.

One-piece shell with 60 mm-thick polyurethane insulation, AISI 304 stainless steel tank.

LED lighting.

Anti-condensation heated glass superstructure, vent-opening front glass, service side closure with sliding Plexiglass doors.

Ventilated refrigeration with two evaporators with double air-flow.

Double hermetic compressor (in models 18 and 24) for optimal refrigeration performance with low noise level. Optional compressor 400/3.

Removable condensing unit for easier, faster maintenance.

Automatic ultra-fast reverse cycle defrost.

Electronic control panel for temperature adjustment.

Climate class 7 (35°/ 75% UR).

DE

Speiseeisvitrine mit einem einzigartigen und ästhetischen Design, perfekt für jedes Ambiente und mit optimaler Sichtbarkeit des Produkts.

Monoblock-Gehäuse mit 60 mm dicker Polyurethan-Hartschaumisolierung, Edelstahlwanne AISI 304.

LED-Beleuchtung.

Beheizter Glasaufsatz mit Wärmedämmverglasung, Frontscheibe mit Klappöffnung, Schließung der Bedienerseite mit Plexiglas-Schiebescheibe.

Umluftkühlung, zwei Verdampfer mit doppelter Luftströmung.

Doppelter hermetischer Kompressor (für Modelle 18 und 24) für erstklassige Kühlleistung, extrem geräuscharm. Optional erhaltlicher Kompressor 400/3.

Entnehmbares Verflüssigeraggregat für einfache und rasche Wartung.

Ultraschnelle automatische Abtauung durch Zyklusinversion.

Elektronisches Schaltpult zum Einstellen der Temperatur.

Klimaklasse 7 (35°/ 75% UR).

FR

Vitrine à glace à l'empreinte esthétique unique et lunaire, adaptée pour n'importe quel type de lieu, avec une visibilité étendue du produit exposé.

Châssis monobloc avec isolation en polyuréthane épaisseur 60 mm cuve en acier inox AISI 304.

Éclairage à LED.

Montant vitres réchauffées anti-condensation, ouverture de la vitre frontale par compas, fermeture côté service avec coulissants en plexiglas.

Réfrigération ventilée avec deux évaporateurs à double flux d'air.

Double compresseur hermétique (dans les modèles 18 et 24) pour des performances de réfrigération optimales, avec niveau de bruit bas.

Compresseur 400/3 optionnel.

Unité de condensation amovible pour un entretien simple et rapide.

Dégivrage automatique ultra rapide, à cycle inversé.

Tableau de commandes électronique pour le réglage de la température.

Classe climatique 7 (35°/ 75% UR).

MOON Gelato



REFRIGERAZIONE VENTILATA CON DOPPIO FLUSSO D'ARIA
 VENTILATED REFRIGERATION WITH DOUBLE AIR FLOW
 UMLUFTKÜHLUNG MIT DOPPELTEM LUFTSTROM
 RÉFRIGÉRATION VENTILÉE AVEC DOUBLE FLUX DE L'AIR



DATI TECNICI / TECHNICAL DATA / TECHNISCHE DATEN / DONNEES TECHNIQUES

MOD.									 [°C]	POTENZA COMPRESSORE / POWER COMPRESSOR PUISSANCE COMPRESSEUR / LEISTUNG VERDICHTER						N. Classe climatica No. Climate class Klimaklasse N° Classe climatique N° [C°/%UR]
	L	P	H	 [kg]	L	P	H	 [kg]		Monofase / Single-phase / Einphasig / Monophasé			Trifase / Three-phase / Dreiphasig / Triphasé			
										Tensione Supply Spannung Tension [V/Hz]	Regime Output Verhältnis Régime [Kw]	Sbrinamento In Defrost Zeitgesteuerte Dégivrage [Kw]	Tensione Supply Spannung Tension [V/Hz]	Regime Output Verhältnis Régime [Kw]	Sbrinamento In Defrost Zeitgesteuerte Dégivrage [Kw]	
MOON GELATO 12	110	112	122	235	122	127	156	305	-16 / -18	230/1/50	1.51	2.15	400/3/50	1.3	2.52	7 (35/75)
MOON GELATO 18	160	112	122	325	172	127	156	402	-16 / -18	230/1/50	2.08	3.53	400/3/50	1.97	3.87	7 (35/75)
MOON GELATO 24	214	112	122	390	226	127	156	479	-16 / -18	230/1/50	2.5	3.8	400/3/50	2.8	5.1	7 (35/75)

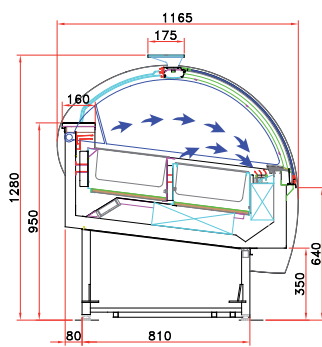

Base / Basic
Basis / Base

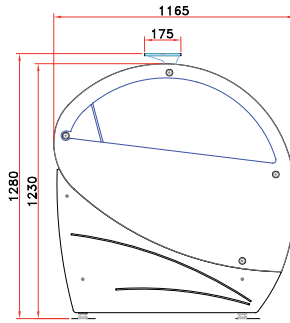

Pannellata / With panels
Mit Paneelen / Avec des panneaux

MOON GELATO 12

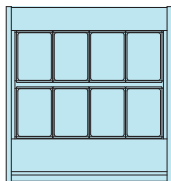
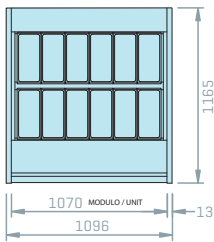

MOON GELATO 18

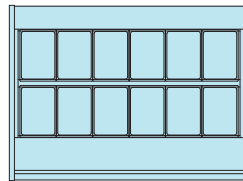
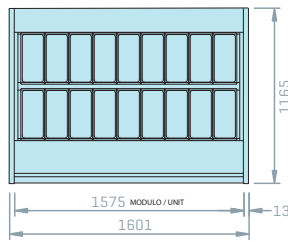

MOON GELATO 24

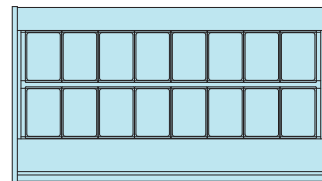
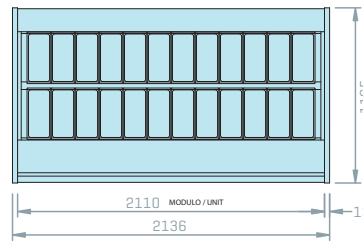

STANDARD L x P x H
360 x 165 x 120 [5Lt.]
360 x 165 x 150 [7Lt.]

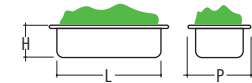

LARGE L x P x H
360 x 250 x 80 [7Lt.]
360 x 250 x 120 [10Lt.]
360 x 250 x 150 [12Lt.]

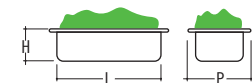

DI SERIE / STANDARD / DI SERIE / SÉRIE

Sbrinamento auto. elettr. / Automatic electric defrost / Zeitgesteuerte abtauautomatik / Dégivrage automatique
Unità di controllo elettr. / Electronic control unit / Elektronische steuereinheit / Unité de contrôle électronique
Fluido refrigerante R404A / R404A refrigerant gas / Kühlgas R404A / Gaz réfrigérant R404A

COLORI / COLOURS / FARBEN / COULEURS



Le vetrine possono essere personalizzate nei colori RAL in commercio.
The showcase can be customized in colors according to available RAL.
Die Vitrinen können in handelsüblichen RAL-Farben gestaltet werden.
Les vitrines peuvent être personnalisées selon les coloris RAL dans le commerce.



Italian Gelato Concepts Pty Limited
Unit 1, 37 Mortimer Road
Acacia Ridge Qld 4110

Bris Office: +61 [0] 7 3162 7724
Syd Office +61 [0] 2 8311 9701
Email: info@italiangelato.com.au

www.italiangelato.com.au



SOLUZIONI D'ARREDO PER FOOD & BEVERAGE

AF DESIGN 0118 - ICEVISION