



ICE VISION ION

POP



SOLUZIONI D'ARREDO PER FOOD & BEVERAGE

Il freddo e' il nostro habitat



POP



Pop

Gelato

IT

Con la semplicità delle sue forme, Pop rende il gelato l'assoluto protagonista.

Scocca monoblocco con isolamento in poliuretano spessore mm 60, vasca interna in LP.

Illuminazione a LED.

Alzata vetri riscaldati anticondensa, apertura del vetro frontale a compasso, chiusura lato servizio con scorrevoli in plexiglass.

Pannelli decorativi in colore bianco.

Refrigerazione ventilata con doppio evaporatore.

Doppio compressore ermetico (nei modelli 16 e 18) per ottime prestazioni frigo, con basso livello di rumorosità.

Unità condensatrice estraibile per una manutenzione semplice e veloce.

Sbrinamento automatico ultrarapido, ad inversione di ciclo.

Quadro comandi elettronico per la regolazione della temperatura.

Classe climatica 7 (35°/ 75% UR).

EN

With the simplicity of its forms, Pop makes gelato the absolute protagonist.

One-piece shell with 60 mm-thick polyurethane insulation, internal LP tank.

LED lighting.

Anti-condensation heated glass superstructure, vent-opening front glass, service side closure with Plexiglass doors.

Ventilated refrigeration with double evaporators.

Double hermetic compressor (in models 16 and 18) for optimal refrigeration performance with low noise level. Optional compressor 400/3.

Removable condensing unit for easier, faster maintenance.

Automatic ultra-fast reverse cycle defrost.

Electronic control panel for temperature adjustment.

Climate class 7 (35°/ 75% UR).

DE

Durch die einfache Formgebung macht Pop das Eis zu einem Blickfang.

Monoblock-Gehäuse mit 60 mm dicker Polyurethan-Hartschaumisolierung, Innenschale aus Kunstschichtstoff. LED-Beleuchtung.

Beheizter Glasaufsatz mit Wärmedämmverglasung, Frontscheibe mit Klappöffnung, Schließung der Bedienerseite mit Plexiglas-Schiebescheibe.

Umluftkühlung mit zwei Verdampfern.

Doppelter hermetischer Kompressor (für Modelle 16 und 18) für erstklassige Kühlleistung, extrem geräuscharm. Optional erhältlicher Kompressor 400/3.

Entnehmbares Verflüssigeraggregat für einfache und rasche Wartung.

Ultraschnelle automatische Abtauung durch Zyklusinversion.

Elektronisches Schaltpult zum Einstellen der Temperatur.

Klimaklasse 7 (35°/ 75% UR).

FR

Avec la simplicité de ses formes, Pop fait de la glace la protagoniste absolue.

Châssis monobloc avec isolation en polyuréthane épaisseur 60 mm, barquette interne en LP (laminé plastique).

Éclairage à LED.

Montant vitres réchauffées anti-condensation, ouverture de la vitre frontale par compas, fermeture côté service avec coulissant en plexiglas.

Réfrigération ventilée avec double évaporateur.

Double compresseur hermétique (dans les modèles 16 et 18) pour des performances de réfrigération optimales, avec niveau de bruit bas.

Compresseur 400/3 optionnel.

Unité de condensation amovible pour un entretien simple et rapide.

Dégivrage automatique ultra rapide, à cycle inversé.

Tableau de commandes électronique pour le réglage de la température.

Classe climatique 7 (35°/ 75% UR).



REFRIGERAZIONE VENTILATA
 VENTILATED REFRIGERATION
 UMLUFTKÜHLUNG
 RÉFRIGÉRATION VENTILÉE



DATI TECNICI / TECHNICAL DATA / TECHNISCHE DATEN / DONNEES TECHNIQUES

MOD.									 [°C]	POTENZA COMPRESSORE / POWER COMPRESSOR PUISSANCE COMPRESSEUR / LEISTUNG VERDICHTER						N. Classe climatica No. Climate class Klimaklasse N° Classe climatique N° [C°/%UR]
	L	P	H	 [kg]	L	P	H	 [kg]		Monofase / Single-phase / Einphasig / Monophasé			Trifase / Three-phase / Dreiphasig / Triphasé			
										Tensione Supply Spannung Tension	Regime Output Verhältnis Régime	Sbrinamento In Defrost Zeitgesteuerte Dégivrage	Tensione Supply Spannung Tension	Regime Output Verhältnis Régime	Sbrinamento In Defrost Zeitgesteuerte Dégivrage	
[cm]	[cm]	[cm]		[cm]	[cm]	[cm]		[V/Hz]	[Kw]	[Kw]	[V/Hz]	[Kw]	[Kw]			
POP GELATO 12	113	103	128	240	127	121	156	275	-16 / -18	230/1/50	1.51	2.15	400/3/50	1.3	2.52	7 (35/75)
POP GELATO 16	148	103	128	310	178	121	156	342	-16 / -18	230/1/50	2.08	3.53	400/3/50	1.97	3.87	7 (35/75)
POP GELATO 18	164	103	128	330	178	121	156	362	-16 / -18	230/1/50	2.08	3.53	400/3/50	1.97	3.87	7 (35/75)

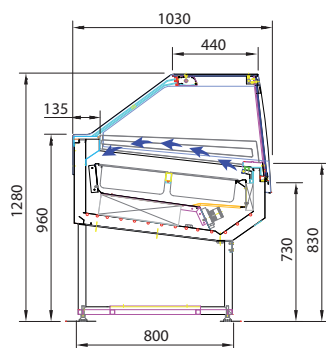

Base / Basic
Basis / Base

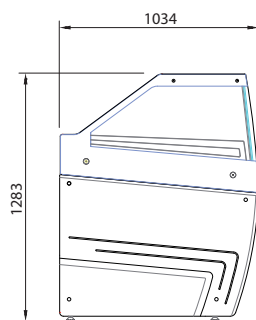

Pannellata / With panels
Mit Paneelen / Avec des panneaux

POP GELATO 12

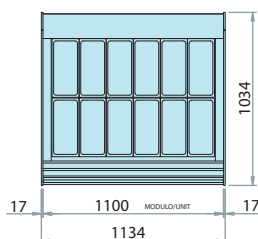

POP GELATO 16

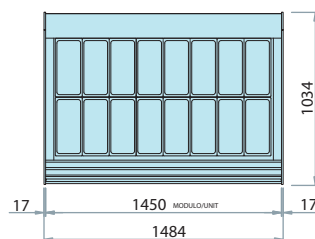

POP GELATO 18

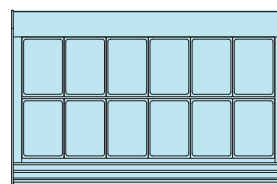
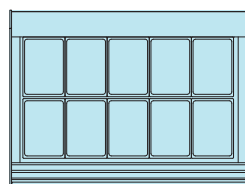
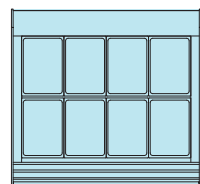
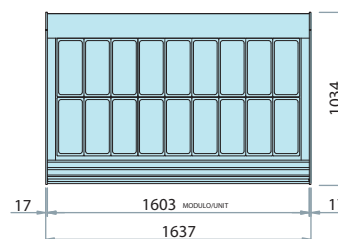

STANDARD L x P x H
360 x 165 x 120 [5Lt.]



LARGE L x P x H
360 x 250 x 80 [7Lt.]
360 x 250 x 120 [10Lt.]



DI SERIE / STANDARD / DI SERIE / SÉRIE

Sbrinamento auto. elettr. / Automatic electric defrost / Zeitgesteuerte abtauautomatik / Dégivrage automatique
Unità di controllo elettr. / Electronic control unit / Elektronische steuereinheit / Unité de contrôle électronique
Fluido refrigerante R404A / R404A refrigerant gas / Kühlgas R404A / Gaz réfrigérant R404A

COLORI / COLOURS / FARBEN / COULEURS



Le vetrine possono essere personalizzate nei colori RAL in commercio.
The showcase can be customized in colors according to available RAL.
Die Vitrinen können in handelsüblichen RAL-Farben gestaltet werden.
Les vitrines peuvent être personnalisées selon les coloris RAL dans le commerce.



Italian Gelato Concepts Pty Limited
Unit 1, 37 Mortimer Road
Acacia Ridge Qld 4110

Bris Office: +61 [0] 7 3162 7724
Syd Office +61 [0] 2 8311 9701
Email: info@italiangelato.com.au

www.italiangelato.com.au



SOLUZIONI D'ARREDO PER FOOD & BEVERAGE