



Multistage Pumps

MPE

Technical Data

Performance Range:

- Capacity up to 300m³/h (1320USgpm)
- Head up to 850m (2780feet)
- Speed up to 2950/3550min⁻¹ (2950/3550rpm)

Size:

- DN 100 up to DN 125 discharge (2,5" - 5")
- Design MP and P refer to separate brochure

Temperature:

- max. 140°C (284°F) without cooling
- max. 180°C (356°F) with cooling

Casing Pressure:

- max. 100 bar (1450 psig)
For detailed operation limits refer to technical data sheets or quotation.

Handled Liquids:

- Clean or slightly contaminated fluids
(without bigger solids)
- Cold and hot water
- Condensate

Applications:

- General industry
- Snow-making systems
- Steel mills
- Sugar industry
- Pulp and paper industry
- Power plants
- Reverse Osmosis
- Mine dewatering

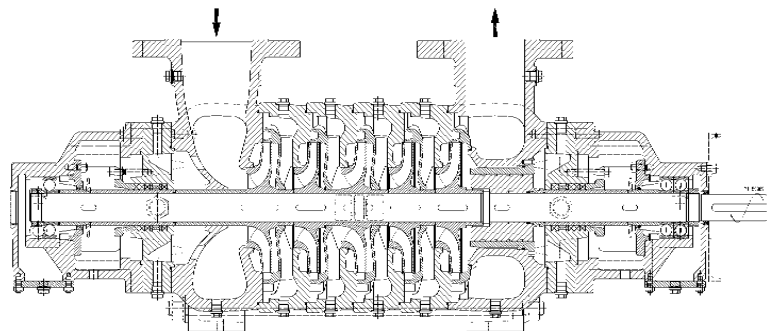

Performance 2950 rpm

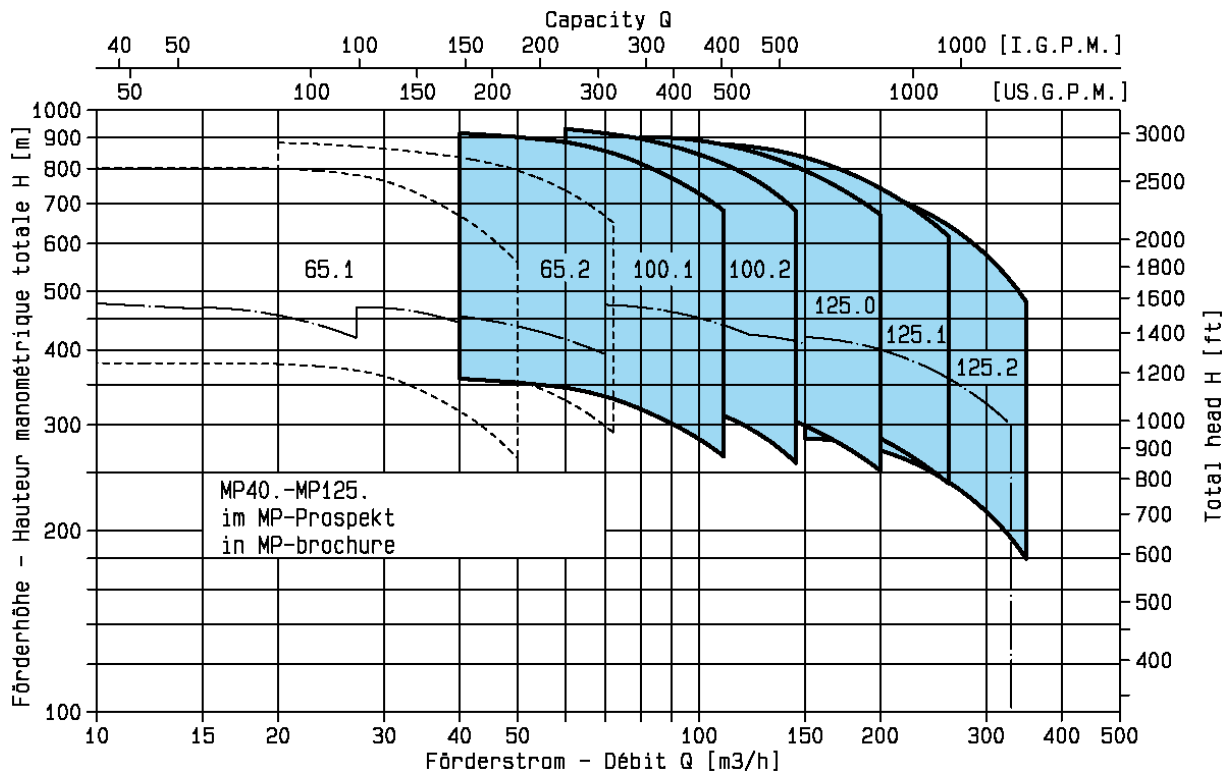

Performance 3550 rpm

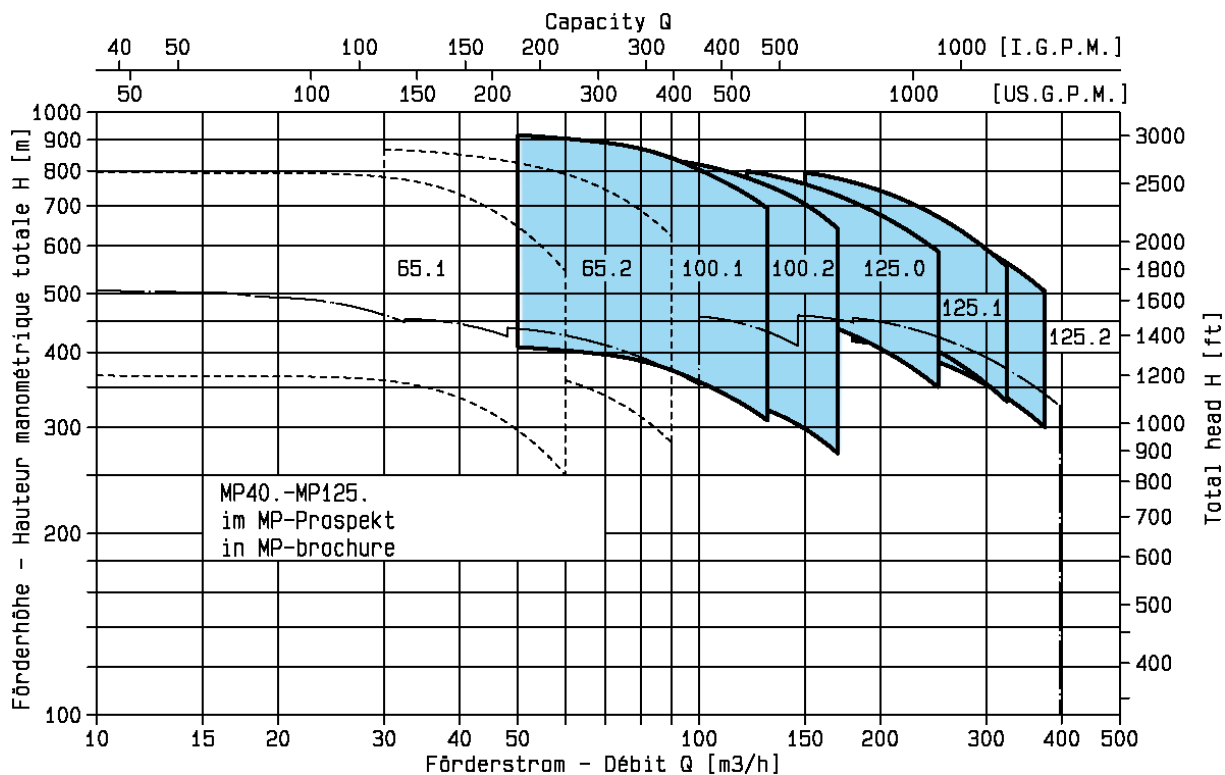

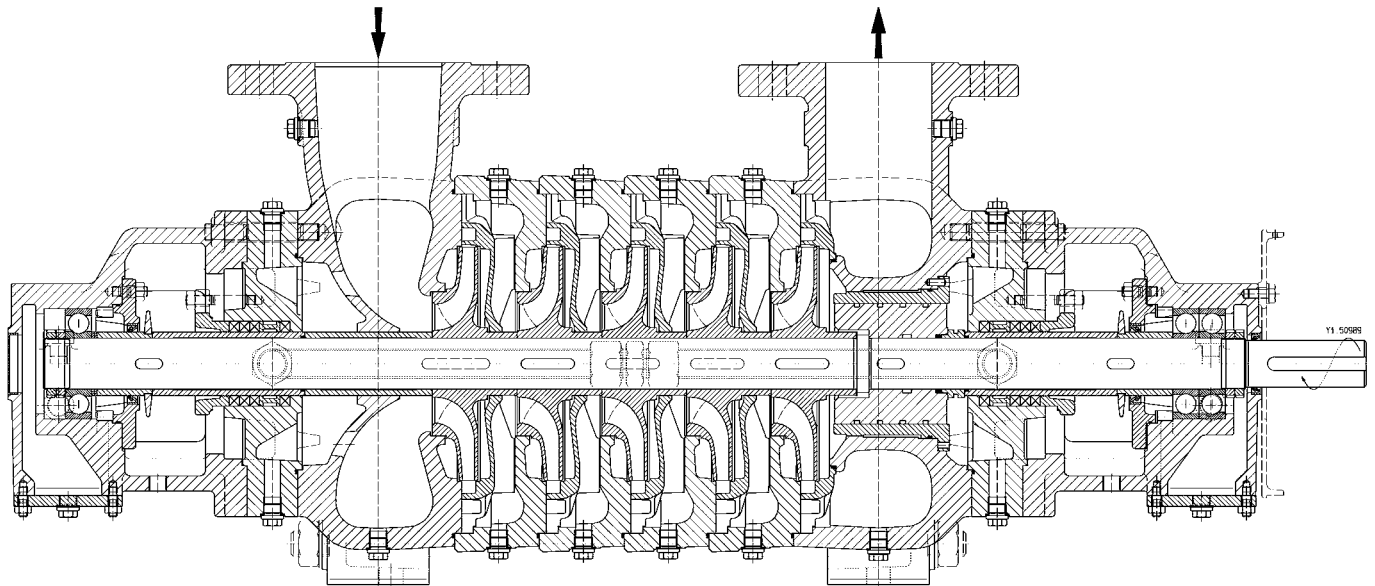

Design Features MPE:

The construction is based on more than 100 years of experience in manufacturing of multi-stage pumps and is designed for smooth running with extremely low vibration level, reliable operation, lowest wear as well as long life time in particular of shaft seals and pump bearings. This is reflected in a considerable drop of lifecycle cost to lowest possible level.

- Horizontal, „in-between“ bearing design, with stiff shaft for lowest shaft deflection.
- Efficiency optimized closed impellers and diffusers avoid radial loads and minimize shaft loads and shaft deflection.
- Thrust balancing by balancing drum with pressure balancing at the discharge side shaft seal considerably reduces the loads on pump bearings and shaft seals.
- Rigid construction with pump feet integrated to pump casing ensures deform-less transmission of pipework loads into foundation.
- Suction- and discharge casing executed with „universal“ casing feet for easy change of flange directions.
- Thermal expansion of the pump rotor is balanced internally by a floating bearing at suction side, without affecting the shaft alignment.
- Maintenance friendly design enables the change of bearings and shaft seals without pump disassembly.

Shaft Sealing

Due to the balancing drum with pressure balancing pipe the pressure at the discharge side shaft seal is reduced to a level only slightly higher than at suction side. Therefore the lifetime of gland packing respectively mechanical seal is considerably increased.

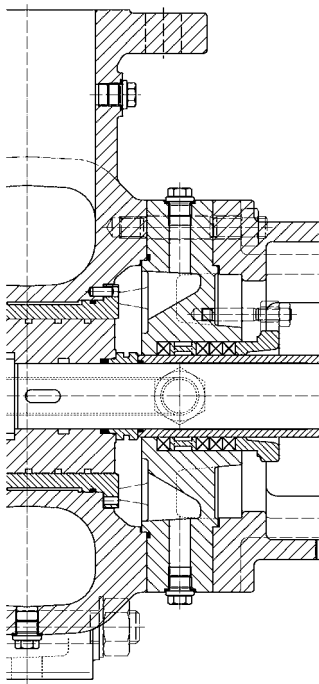

Stuffing Box

Stuffing box with shaft sleeve and lantern ring.
Standard execution with internal flush.
External flush option available, in case of vacuum during standstill of pump.

Up to temperatures of 120°C (248°F)

Mechanical Seal

Balanced single mechanical seal according to EN 12756 (DIN 24960) at both sides. Standard execution with internal flush, optional external flush.

Temperatures up to 140°C (284°F) without cooling
> 140°C (284°F) up to 180°C (356°F) with cooling of the stationary ring.

Cartridge mechanical seals, in single or double design, are available on request.

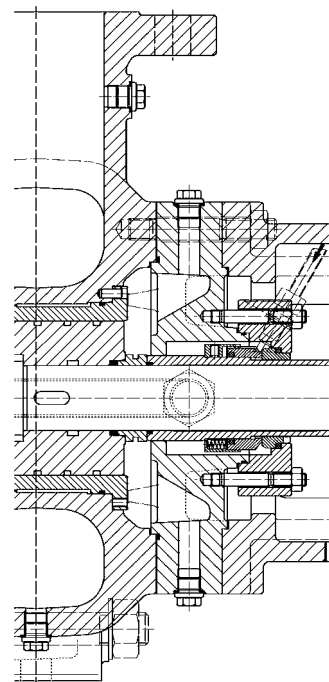

Design Versions

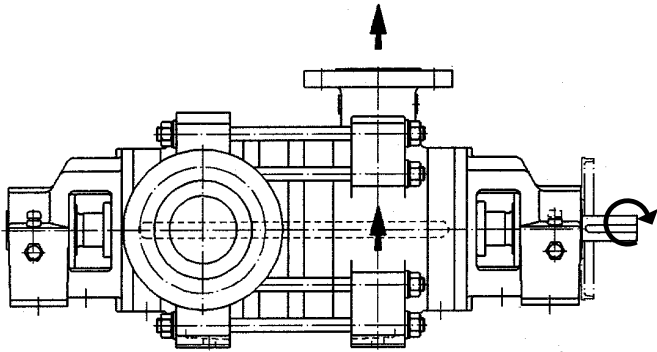

Drive-end at discharge side: standard execution
Sense of rotation clockwise seen from drive side

Drive-end at suction side - optional

Flexibility at installations with limited space
Sense of rotation counter clockwise seen from drive side.

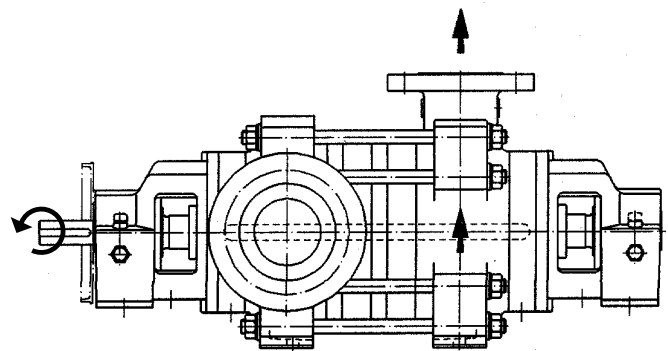

Branch Directions

Standard Branch Direction

Discharge branch at drive side, vertically upwards, suction branch at non-drive side, horizontally left seen from drive side

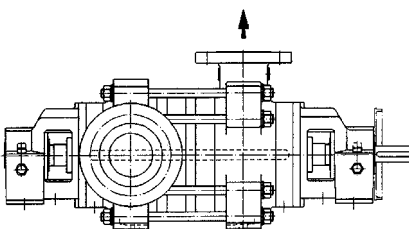

Optional Branch Directions

Discharge as well as suction branch direction can be horizontally left or right or vertically upwards (both branches in the same direction only possible for 3 or higher number of stages).
The design with integral casing feet enables changing of branch directions by using the same components.

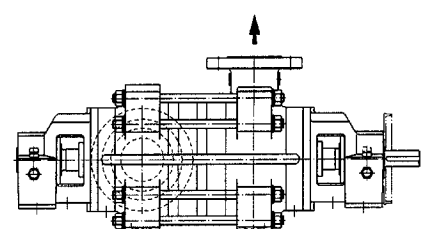
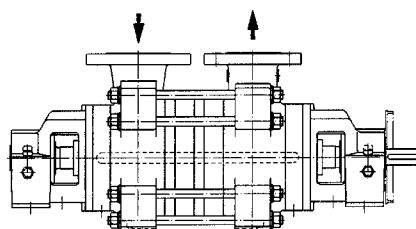

Materials

Code	Impeller	Diffuser	Suction- and Stage casing	Discharge casing	Bearing frame	Shaft	Sleeve
141	0.6025	0.6025	0.7040	1.0619	0.6025	1.4021	1.4021
341	1.4408	0.6025	0.7040	1.0619	0.6025	1.4021	1.4021
672	1.4517	1.4517	1.4517	1.4517	0.6025	1.4462	1.4462

141, 341: Balancing drum 1.4021, balancing bush 1.4313
672: Balancing drum 1.4462 coated, balancing bush 1.4462
Other materials upon request

ISO 9001 + 14001 certifications guarantee high quality standards and reliability of our products as well as environmentally friendly production process.



Accessories

- Baseframe in welded design
- Flexible coupling
- Coupling guard, made of stainless steel 1.4571 in standard execution
- Motor
- Speed controllers
- Minimum flow- and non return valves
- Special accessories according to customer requirements



Xylem |'zīləm|

- 1) The tissue in plants that brings water upward from the roots;
- 2) a leading global water technology company.

We're 12,000 people unified in a common purpose: creating innovative solutions to meet our world's water needs. Developing new technologies that will improve the way water is used, conserved, and re-used in the future is central to our work. We move, treat, analyze, and return water to the environment, and we help people use water efficiently, in their homes, buildings, factories and farms. In more than 150 countries, we have strong, long-standing relationships with customers who know us for our powerful combination of leading product brands and applications expertise, backed by a legacy of innovation.

For more information on how Xylem can help you, go to xylem.com.



Xylem Water Solutions Austria GmbH
A-2000 Stockerau
Ernst Vogel-Straße 2
Tel +43-2266-604
Fax +43-2266-65 311
info.austria@xylem.com
www.xylemaustria.com