

OPERATOR'S MANUAL

INCLUDING: OPERATION, INSTRUCTION, INSTALLATION, MAINTENANCE AND PARTSBOOK



IMPORTANT: READ THIS MANUAL CAREFULLY BEFORE INSTALLING, OPERATING OR SERVICING THIS TOOL.

AIR HOCK CUTTER



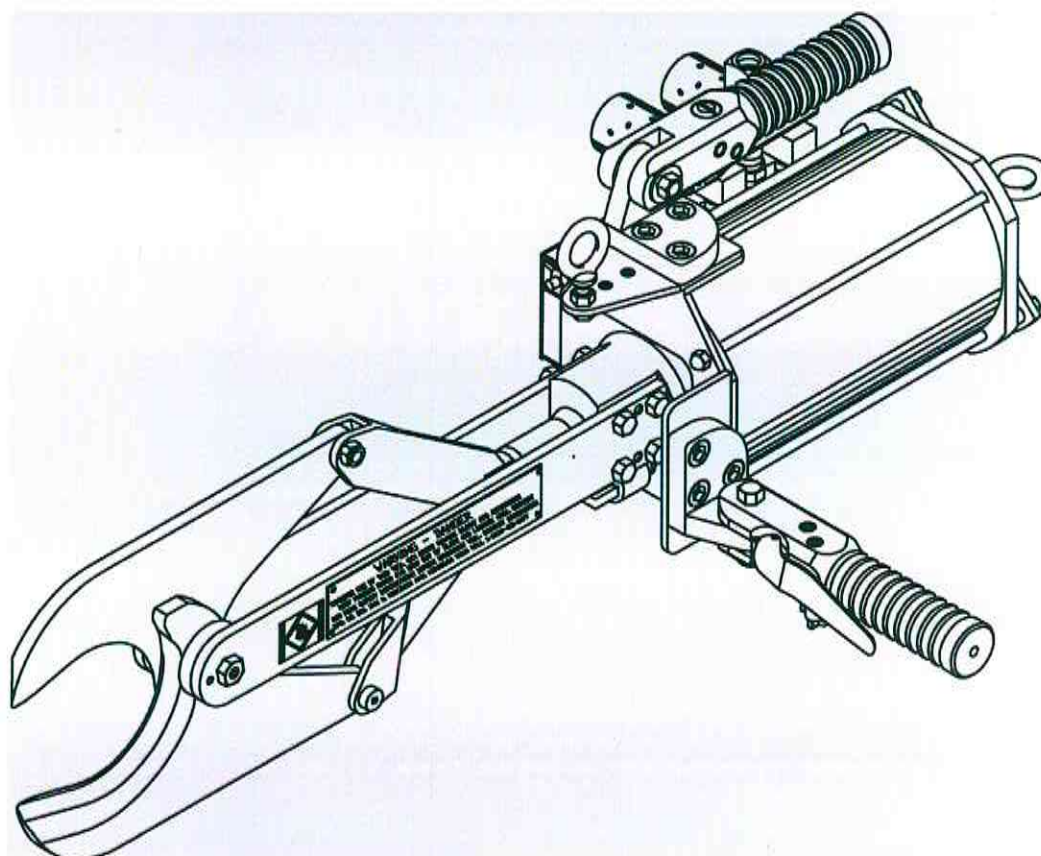











TOOL DATA

MODEL: AHC
ASSEMBLY NO. 623000
TYPE: AIR OPERATED
NET WEIGHT: 29 LBS (13.2 KG)
INLET AIR PRESSURE: 90 P.S.I. (6.9 BARS)



| | |
|--|---|
|  WARNING | = Hazards or unsafe practices which could result in severe personal injury, death or substantial property damage. |
|  CAUTION | = Hazards or unsafe practices which could result in minor personal injury, product or property damage. |
|  NOTICE | = Important installation, operation or maintenance information. |

OPERATING AND SAFETY INSTRUCTIONS

-  **WARNING** DO NOT OPERATE THIS TOOL UNTIL YOU HAVE READ AND UNDERSTOOD THE SAFETY INSTRUCTIONS AND OPERATING MANUALS.
-  **WARNING** DO NOT OPERATE THIS TOOL UNTIL YOU HAVE RECEIVED TRAINING IN THE HANDLING, OPERATION AND USE OF THIS TOOL.
-  **WARNING** STOP USING A MALFUNCTIONING OR DEFECTIVE TOOL IMMEDIATELY. REPORT ANY PROBLEMS OR DEFECTS TO YOUR SUPERVISOR FOR REMOVAL OF THE TOOL FROM SERVICE.
-  **WARNING** DO NOT ATTEMPT TO REPAIR THE TOOL YOURSELF.
-  **WARNING** DO NOT ALLOW UNAUTHORIZED PERSONS TO USE TOOL.
-  **WARNING** REMOVE AND DISCONNECT POWER FROM THE TOOL WHEN TOOL IS LEFT UNATTENDED OR IS NOT IN USE.
-  **WARNING** NEVER TIE DOWN, BYPASS, ALTER OR MODIFY THE ACTIVATING SWITCHES OR TRIGGERS OF THIS TOOL.
-  **WARNING** NEVER MAKE ALTERATIONS OR MODIFICATIONS TO THIS TOOL.
-  **WARNING** BE CONSTANTLY AWARE AND ALERT FOR UNSAFE CONDITIONS AND REPORT THEM IMMEDIATELY TO YOUR SUPERVISOR.
-  **WARNING** NEVER PLACE YOUR HAND OR ANY PART OF YOUR BODY IN THE CUTTING PATH OF THE TOOL.
-  **WARNING** NEVER ALLOW ANYONE ELSE TO PLACE THEIR HANDS OR ANY PART OF THEIR BODY IN THE CUTTING PATH OF THE TOOL.
-  **WARNING** DO NOT ACTIVATE CONTROL SWITCHES OR TRIGGERS OF THIS TOOL UNLESS YOU INTEND TO TEST OR OPERATE THIS TOOL.
-  **WARNING** DO NOT USE THIS TOOL FOR ANY PURPOSE OTHER THAN IT'S INTENDED PURPOSE.
-  **CAUTION** WHEN OPERATING THIS TOOL WEAR THE PROTECTIVE GEAR AND SAFETY EQUIPMENT SUPPLIED TO YOU.
-  **WARNING** THE NOISE EMISSION (SOUND PRESSURE LEVEL) AT THE WORKSTATION MAY EXCEED 80 dB (A). EAR AND SOUND PROTECTION GEAR IS REQUIRED.

OPERATING INSTRUCTIONS

⚠ WARNING ONLY TRAINED PERSONNEL ARE TO OPERATE THIS TOOL.

1. TO ENSURE TOOL IS OPERATING PROPERLY, PERFORM FOLLOWING STEPS AT START OF EACH SHIFT:
 - MAKE SURE TOOL MOVES UP AND DOWN FREELY WHILE HANGING FROM BALANCER OVERHEAD.
 - WITH POWER TO TOOL TURNED ON, TEST TRIGGER FOR PROPER OPERATION.
 - DEPRESS EACH TRIGGER SEPARATELY. TOOL SHOULD NOT ACTIVATE. DEPRESS BOTH TRIGGERS. TOOL SHOULD ACTIVATE.
 - IF TOOL HAS "ANTI-TIE DOWN" OPTION, BOTH TRIGGERS MUST BE DEPRESSED SIMULTANEOUSLY FOR TOOL TO ACTIVATE.
2. TO PERFORM WORK, HOLD TOOL FIRMLY AT BOTH HANDLES. SQUEEZE TRIGGERS TO ACTIVATE TOOL.
3. POSITION TOOL AND PERFORM CUTTING OPERATION.

MAINTENANCE

⚠ WARNING ONLY TRAINED AND QUALIFIED PERSONNEL ARE TO PERFORM MAINTENANCE AND SERVICE TO THIS TOOL.

1. MAKE ALL NECESSARY LINE CONNECTIONS TO THE TOOL.
2. AN AIR FILTER-REGULATOR-LUBRICATOR (PART NO. 7200030) MUST BE INSTALLED IN AIR SUPPLY FOR EACH TOOL.
3. FILL LUBRICATOR WITH KENTMASTER AIR MIST OIL (PART NO. 7903050). SET DRIP RATE ACCORDING TO INSTRUCTIONS SUPPLIED. TURN ADJUSTMENT ON SIGHT FEED DOME TO INCREASE/DECREASE OIL DELIVERY. MONITOR THE DEVICE BEING LUBRICATED AND READJUST IF NEEDED.
4. TOOL REQUIRES 90 P.S.I. AIR PRESSURE.
5. TOOL REQUIRES GREASING AFTER EVERY SHIFT. GREASE USING KENTMASTER GREASE (PART NO. 7903070).
6. GREASE BLADES THRU PIN 623016. FIGURE 1.

BLADE REMOVAL AND CLEANING.

⚠ WARNING ALWAYS DISCONNECT POWER SUPPLY FROM TOOL BEFORE INSTALLING OR REMOVING BLADE FROM TOOL.

⚠ WARNING ALWAYS WEAR WIRE MESH GLOVES WHEN INSTALLING OR REMOVING BLADE FROM TOOL.

TO REMOVE OR CHANGE BLADES (PROCEDURE NOT NECESSARY TO CLEAN BLADES):

1. REMOVE (2) NUTS AND (2) BOLTS (ITEMS NO. 887035 AND 850413)
2. REMOVE PIN AND NUT (ITEM NO. 623016 AND 850472, FIG. NO. 1).
3. SLIDE OUT BLADES (ITEMS 623032).
4. CLEAN ALL PARTS REMOVED WITH SOAP AND WATER.
5. SHARPEN OR REPLACE BLADES WHEN NECESSARY.
6. REASSEMBLE IN REVERSE ORDER.

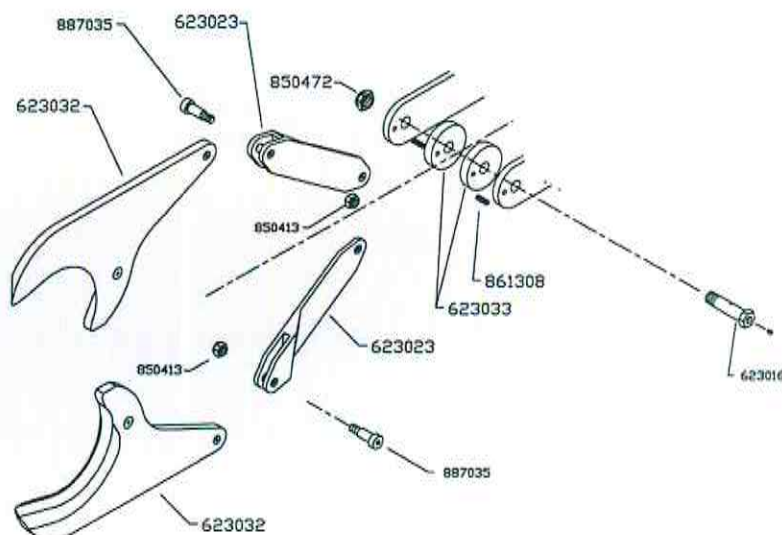
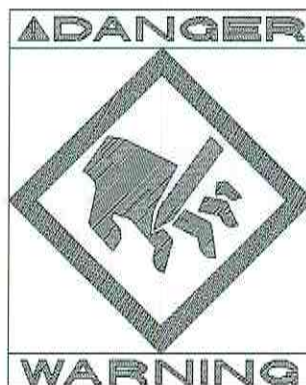
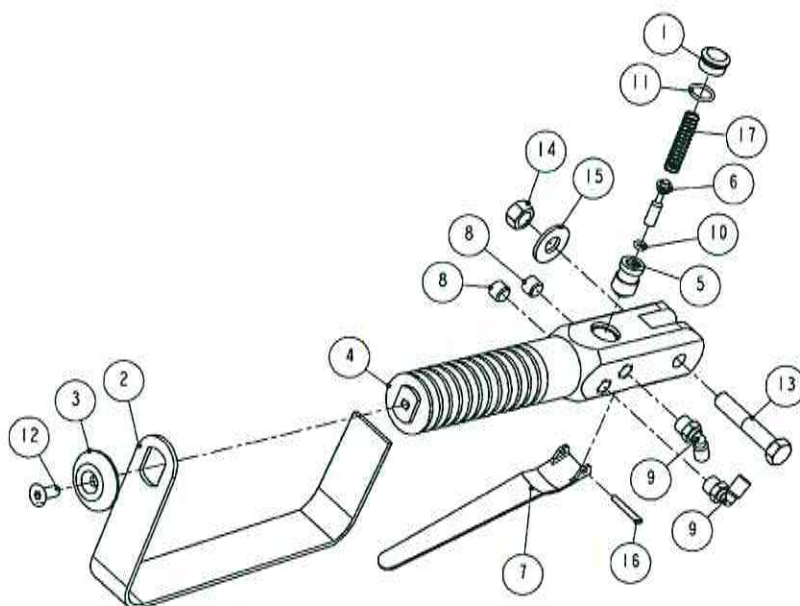

Figure 1 MODEL AHC – BLADE REPLACEMENT

SERVICE

1. KEEP GOOD RECORDS OF ALL SERVICE ACTIVITY AND INCLUDE TOOL IN PREVENTIVE MAINTENANCE PROGRAM.
2. USE ONLY GENUINE KENTMASTER REPLACEMENT PARTS TO ASSURE PROPER PERFORMANCE OF TOOL.
3. CONTACT THE KENTMASTER SUPPLIER NEAREST YOU FOR PARTS AND CUSTOMER SERVICE INFORMATION.



HANDLES

| 6600530: AIR HANDLE | | | |
|---------------------|---------|-------------|-----|
| ITEM | PART # | DESCRIPTION | QTY |
| 1 | 6300770 | VALVE PLUG | 1 |
| 2 | 6541690 | GUARD | 1 |
| 3 | 6541720 | RETAINER | 1 |
| 4 | 6600340 | HANDLE | 1 |
| 5 | 6600350 | BUSHING | 1 |
| 6 | 6600360 | VALVE STEM | 1 |
| 7 | 6600500 | LEVER | 1 |
| 8 | 7000010 | PLUG | 2 |
| 9 | 7036510 | ELBOW | 2 |
| 10 | 7680080 | O-RING | 1 |
| 11 | 7680140 | O-RING | 1 |
| 12 | 8241050 | SCREW | 1 |
| 13 | 8415160 | SCREW | 1 |
| 14 | 8500150 | NUT | 1 |
| 15 | 8505160 | WASHER | 1 |
| 16 | 8653140 | PIN | 1 |
| 17 | 8890010 | SPRING | 1 |

Figure 3 6600530: AIR HANDLE**CYLINDER**

**INSPECT ALL O-RINGS AND SEALS FOR ANY CUTS OR FLAT SPOTS (THESE CAN CAUSE LEAKS).
REPLACE PARTS AS NEEDED.**

[ENGLISH]

GENERAL INFORMATION

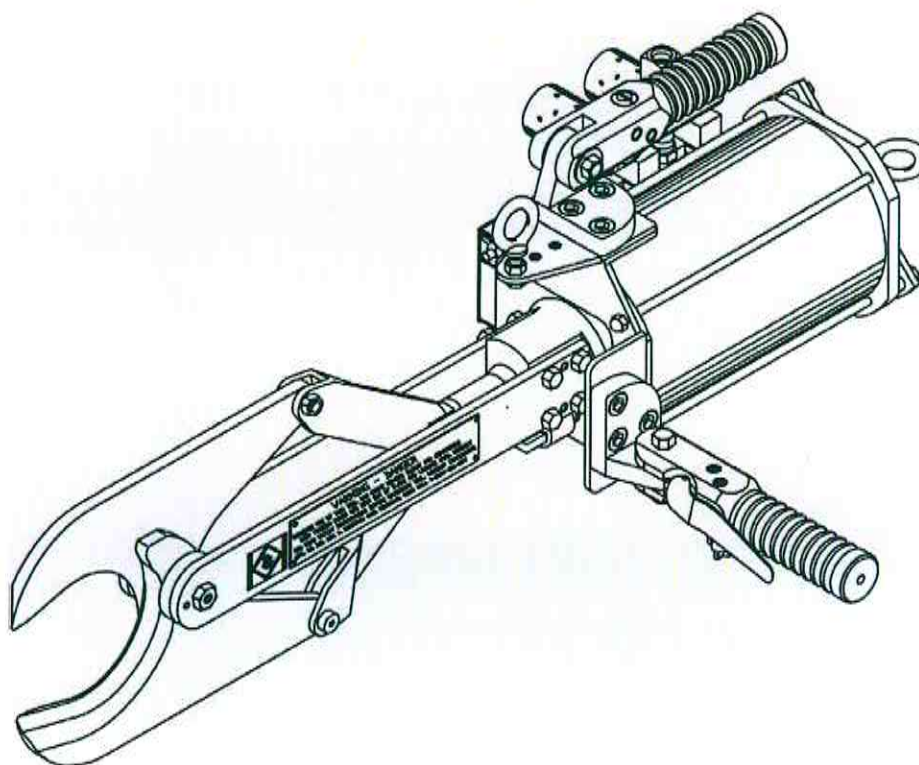

MODELS

“AHC” AIR HOCK CUTTER (6300000)

SERVICE CENTERS

KENTMASTER LTD. (U.K)
16 AVONBANK INDUSTRIAL CENTRE
WEST TOWN ROAD
AVONMOUTH - BRISTOL BS11 9DE
UNITED KINGDOM

☎ TELEPHONE: ++ 44- (0) 117- 9235035
FAX: ++ 44- (0) 117- 9829010

KENTMASTER MFG. CO., INC.
1801 SOUTH MOUNTAIN AVE.
MONROVIA, CALIFORNIA 91016
UNITED STATES OF AMERICA

☎ TELEPHONE: (626) 359-8888
FAX: (626) 303-5151

NOTICE TO EMPLOYER AND PURCHASER OF TOOL
NOTICE TO SAFETY DIRECTOR

You have purchased a powerful tool that, if misused, can cause severe injury and harm to your employees. You must instruct your employees in the safe and proper use of this tool and to follow the safety procedures and instructions that have been supplied by the manufacturer of this tool. Please follow the following instructions.

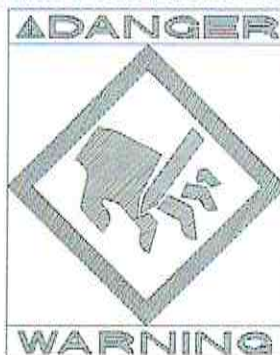

1. Instruct tool operators to test the tool each day before using it to be sure it does not malfunction. Remove and repair any tool that malfunctions.
2. Instruct tool operators to immediately stop using a tool that malfunctions or is defective.
3. Instruct personnel to immediately remove all tools that malfunction. Be sure to disconnect tool from power supply.
4. Instruct all personnel to stay clear of tool, and not to stand or walk in front of, or next to tool when in use.
5. Point out to all personnel the dangers related to the misuse of tool and the importance of following safety procedures and instructions.
6. Do not make, or allow others to make, alterations or modifications to this tool. Replace all lost or illegible labels.
7. Follow all safety, installation and maintenance instructions provided with this tool. Establish proper safety procedures in accordance with local and national requirements to prevent accidental energizing of tool that can cause injuries.
8. If this tool is sold or change in ownership takes place, you must provide the new owner all safety instructions, notices and maintenance instructions you were originally provided. You can obtain additional copies of the instructions from Kentmaster, free of charge upon request.
9. Give copies of instructions to:
 - (A) Tool Operators**
 - (B) Maintenance Supervisor**
 - (C) Clean-up Supervisor**

GENERAL INFORMATION



COVERING: SAFETY PRECAUTIONS AND PLACING INTO SERVICE



AIR OPERATED AIR HOCK CUTTER

READ THIS MANUAL CAREFULLY BEFORE INSTALLING, OPERATING OR SERVICING THIS TOOL

IT IS THE RESPONSIBILITY OF THE EMPLOYER TO PLACE THIS INFORMATION INTO THE HANDS OF THE OPERATOR.

PLACING INTO SERVICE

- | | |
|--|---|
|  WARNING | = Hazards or unsafe practices which could result in severe personal injury, death or substantial property damage. |
|  CAUTION | = Hazards or unsafe practices which could result in minor personal injury, product or property damage. |
|  NOTICE | = Important installation, operation or maintenance information. |

- | | |
|--|--|
|  WARNING | Installation, adjustment repair and maintenance of this tool must be made by trained and qualified personnel. |
|  WARNING | Always disconnect power supply from tool before: (A) Installing or removing blade from tool. (B) Making repairs or adjustments to the tool. (C) performing maintenance or cleanup work. |

DECLARATION OF CONFORMITY

DECLARATION OF CONFORMITY

DECLARATION DE CONFORMITE -DECLARACION DE CONFORMIDAD- ERKLARUNG BEZUGLICH EINHALTUNG DER VORSCHRIFTEN
 DICHIARAZIONE DI CONFORMITA . CONFORMITEITSVERKLARING

MANUFACTURED BY:

FABRIQUE PAR:
 FABRICADA POR:
 HERGESTELLTVON:
 FABBRICATO DA:
 VERVAARDIGD DOOR:

KENTMASTER MFG CO., INC.
1801 SOUTH MOUNTAIN AVE.
MONROVIA, CALIFORNIA 91016
UNITED STATES OF AMERICA
TELEPHONE (626) 359-8888 FAX (626) 303-5151

TYPE / SERIES: AIR HOCK CUTTER

TYPE / SERIE:
 TIPO / SERIE:
 TYP / SERIE:
 TIPO / SERIE:
 TYPE / SERIE:

MODEL: AHC

MODELE:
 MODELO:
 MODELL:
 MODELLO:
 MODEL:

SERIAL NO. RANGE: XXXXX

N SERIE: • GAMA DE No. DE SERIE: • SERIEN-NR.-BEREICH: • NUMERI DI SERIE: • SERIENUMMERS:

This product complies with the following European Community Directives:

Ce produit est conforme aux directives de la Communauté européenne suivantes:
 Este producto cumple con las siguientes Directrices de la Comunidad Europea:
 Dieses Produkt erfüllt die folgenden Vorschriften der Europäischen Gemeinschaft:
 Questo prodotto è conforme alle seguenti direttive CEE:
 Dit produkt voldoet aan de volgende EG-richtlijnen:

89/392/EEC, 91/368/EEC, 93/44/EEC, 93/68/EEC

The following Standards were used to verify compliance with the Directives:

Les normes suivantes ont été utilisées pour vérifier la conformité avec les Directives:
 Las siguientes Normas se usaron para verificar el cumplimiento de las Directrices:
 Folgende Normen wurden angewandt, um Erfüllung der Vorschriften zu bestätigen:
 Per verificare la conformità del prodotto alle direttive sono stati usati i seguenti standard:
 De volgende normen zijn gebruikt om naleving van de richtlijnen te bevestigen:

EN 292

Approved by: _____
 RALPH KARUBIAN MONROVIA, CA. U.S.A
 (Engineering Manager) (Directeur technique) (gerente de ingenieria) (verantwortlicher Konstruktionsleiter) (Responsabile tecnico) (ondersteunend technisch manager)

Date: JAN - 1 - 1995

Kentmaster Worldwide Location

Kentmaster Equipment (Aust) PTY.LTD.
Unit 2,24 Central Court
Browns Plains Qld. 4118
Australia

Telephone: (07) 3806-8400
Fax: (07) 3806-7933
Australia@Kentmaster.com

Kentmaster do Brasil, Ltda.
Av. Dr. Joao Teodoro No. 805
Bairro De Vila Rezende
13405-240 Piracicaba, SP,
Brazil

Telephone #1: (019) 3 413 3113
Telephone #2: (019)983-4973
Fax: (019) 3 413 3113
Brazil@Kentmaster.com

Kentmaster (IRL) LTD.
Benamore, Dublin Road.
Roscrea,
CO, Tipperary,
Ireland

Telephone: (353) 0505-23292
Fax: (353) 0505-23299
Ireland@Kentmaster.com

Kentmaster Equipment (NZ) LTD.
5 Cooper Street
Havelock North
New Zealand

Telephone #1: (64) 6 8777 857
Telephone #2: 0800 KENTMASTER
Fax: (64) 6 8777 858
NewZealand@Kentmaster.com

Kentmaster South Africa (PTY) LTD.
Johannesburg - S. Africa
Unit 54 Sunnyrock Park
Sunrock Close, Germiston
South Africa

Telephone: (27) 11-455-3748
Fax: (27) 11-455-3749
SouthAfrica@Kentmaster.com

Kentmaster (UK) LTD.
Unit 16 Avonbank Ind. Centre
West Town Rd, Avonmouth-Bristol,
BS11 9DE
England

Telephone: (44) 117-923-5035
Fax: (44)-117-932-9010
UK@Kentmaster.com

Kentmaster Mfg. Co., Inc.
1801 South Mountain Ave.
Monrovia, CA, 91016
USA

Telephone #1: (626) 359-8888
Telephone #2: (800) 421-1477
Fax: (626) 303-5151
info@Kentmaster.com

Kentmaster Omaha
4417 South 139th Street
Omaha, NE, 68137
USA

Telephone #1: (402) 896-3355
Telephone #2: (800) 367-3181
Fax: (402) 896-3311
Omaha@Kentmaster.com

INDEX

OPERATING AND SAFETY INSTRUCTIONS..... 2
 OPERATING INSTRUCTIONS..... 3
 MAINTENANCE..... 3
SERVICE 4
PARTS BOOK..... 5
 AHC, MAIN ASSEMBLY 5
 HANDLES 6
 CYLINDER..... 6
GENERAL INFORMATION..... 9
DECLARATION OF CONFORMITY..... 10
Kentmaster Worldwide Location 11
INDEX..... 12
FIGURES - INDEX..... 12

FIGURES - INDEX

Figure 1 MODEL AHC – BLADE REPLACEMENT..... 3
 Figure 2 MODEL “AHC” – MAIN ASSEMBLY 5
 Figure 3 6600530: AIR HANDLE 6