

KOMATSU®

GD655-7

Tier 4 Final Engine

Australia & New Zealand Specifications

MOTOR GRADER



Photos may include optional equipment.

HORSEPOWER

Gross: 165 kW 221 HP/2100 min⁻¹
Net: 163 kW 218 HP/2100 min⁻¹

OPERATING WEIGHT

19,730 kg including Ripper

BLADE LENGTH

4.3 m

GD655

WALK-AROUND

GD655-7



HORSEPOWER

Gross: 165 kW 221 HP/2100 min⁻¹
Net: 163 kW 218 HP/2100 min⁻¹

OPERATING WEIGHT

19,730 kg including Ripper

BLADE LENGTH

4.3 m

NEW FEATURES



Ecology & Productivity Features

- *Komatsu's New Emission Regulations-compliant Engine* **NEW**
- *Engine Power Mode Selection System*
- *Lock-up Torque Converter Transmission with Electronic Control with Anti Stall Function*

Economy & Durability Features

- *High Productivity & Lower Fuel Consumption*
- *Auto Idle Stop Function* **NEW**
- *Change in the Material of Circle Wear Plate to a Resin* **NEW**
- *Reinforced Blade Circle* **NEW**
- *Blade Slide Screw Adjustment* **NEW**
- *Battery Location* **NEW**

Operator Environment

- *Rear View Monitoring System* **NEW**
- *Electronic Proportional Controls (EPC) Blade & Ripper* **NEW**
- *Palm Control or Steering Wheel - Steering* **NEW**

IGT

- *Machine Monitor with Improved Operator Interface* **NEW**
- *Operator Identification Function* **NEW**
- *Energy Saving Operation* **NEW**
- *KOMTRAX*

Maintenance features

- *Easy Access to Service Area*
- *Battery Disconnect Switch* **NEW**

ECOLOGY & PRODUCTIVITY FEATURES

KOMATSU NEW ENGINE TECHNOLOGIES

Komatsu's New Emission Regulations-compliant Engine

New regulations effective in 2014 require the reduction of NOx emissions by 80% compared to Tier 4 interim the preceding regulations. In addition to refining the Tier 4 Interim technologies, Komatsu has developed a new Selective Catalytic Reduction (SCR) device in-house.

Technologies Applied to New Engine

Heavy-duty aftertreatment system

This new system combines a Komatsu Diesel Particulate Filter (KDPF) and SCR. The SCR NOx reduction system injects the correct amount of Diesel Exhaust Fluid (DEF) at the proper rate, thereby decomposing NOx into H₂O and N₂.

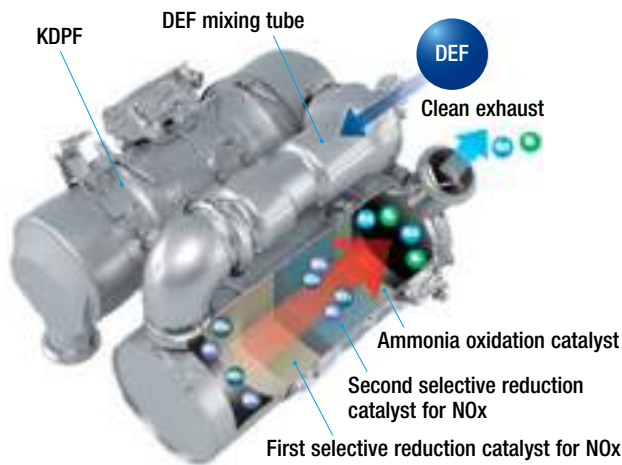

Heavy-duty cooled Exhaust Gas Recirculation (EGR) system

The system recirculates a portion of exhaust gas into air intake and lowers combustion temperatures, thereby reducing NOx emissions.

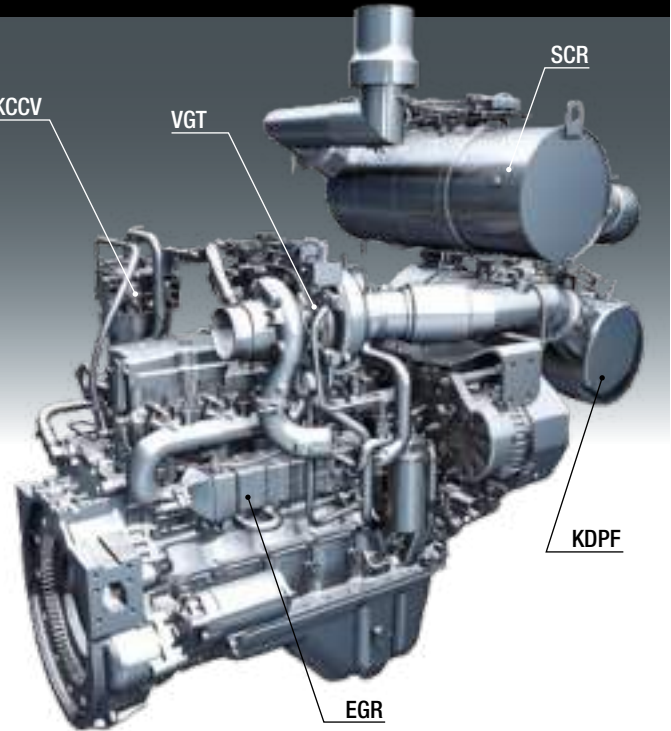
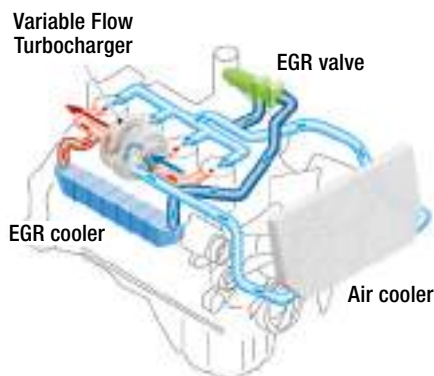

Electronic control system

The electronic control system performs high-speed processing of all signals from sensors installed in the vehicle and engine to ensure total control of equipment in all conditions of use.

Variable Geometry Turbocharger (VGT) system

The VGT system features Komatsu design hydraulic technology for variable control of air-flow and supplies optimal air according to load conditions.

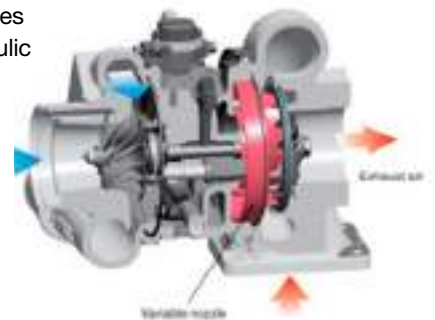

Komatsu Closed Crankcase Ventilation (KCCV)

Oil mist trap efficiency is significantly increased from previous "Breather"s, from around 50% trap efficiency to 95% trap efficiency. Almost oil mist free crankcase gas (blow-by gas) is delivered back to the intake.



High Pressure Common Rail (HPCR) fuel injection system

The system is designed to achieve an optimal injection of high-pressure fuel by means of computerised control, thereby bringing close to complete combustion to reduce particulate matter (PM) emissions.

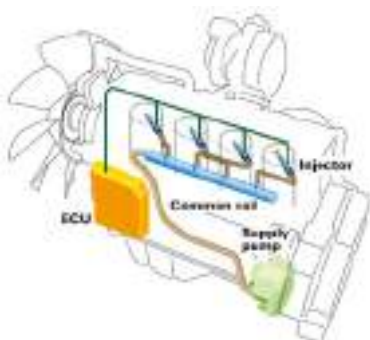

Engine Power Mode Selection System

The system allows selection of the appropriate mode between two modes <P mode> or <E mode> according to each working condition. The mode is easily selected with a switch in the operator's cab.

• P mode

Greater productivity can be attained by taking full advantage of high output power. It is appropriate for job sites where the motor grader meets high resistance.

• E mode

This mode is selected for maximum economy and lighter work applications. This feature provides the appropriate power, better fuel consumption, and prevents tyre wear due to tyre slip.



	Forward kW (HP)			
	P mode		E Mode	
	AUTO	MANU	AUTO	MANU
F1	134 (180)	134 (180)	134 (180)	134 (180)
F2				
F3	149 (200)	149 (200)	134 (180)	134 (180)
F4				
F5				
F6				
F7	163 (218)	163 (218)	163 (218)	163 (218)
F8				

	Reverse kW (HP)			
	P mode		E Mode	
	AUTO	MANU	AUTO	MANU
R1	134 (180)	134 (180)	134 (180)	134 (180)
R2				
R3	149 (200)	149 (200)	134 (180)	134 (180)
R4				

• Lock-up Torque Converter Transmission with Electronic Control

is designed and built specifically for Komatsu graders. The transmission provides on-the-go, full power shifting as well as inching capability and automatic shifting in the higher ranges.

Transmission mode selection system

• Auto mode

Torque converter in F1-F4 gears, easy 2 pedal (accelerator and brake) operation, easy to operate the motor grader, maximum productivity in any application, easy traveling and high maneuverability with automatic gear shifting.

Torque converter produces over 2 times the torque when starting, which allows you to start from 4th gear. The F-5 through F-8 automatic range can be used for smooth and easy operating.

• Manual mode

Direct drive in all gears, works the same way as conventional power shift machine, constant machine speed, more economical operation.

• Engine stall prevention function

If the load increases further, the engine may stall in manual mode similar to competition using a direct drive transmission. The engine stall prevention function will engage prior to the engine stall, it automatically changes to auto mode (with torque converter) to avoid stalling.

• Electronic over-speed protection

helps prevent engine and transmission damage from premature downshifting and grade-induced over speeding.

• Smooth shift with the torque converter curves

during lock-up shifting will protect operator and the equipment such as engine and transmission by minimise the shift shock.

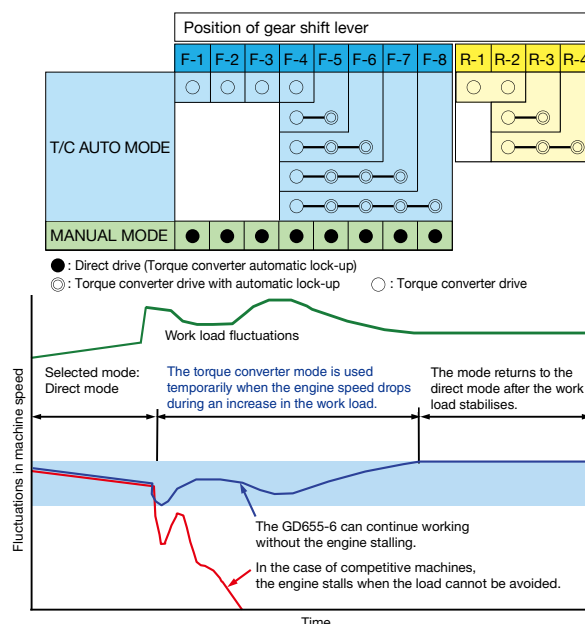

ECONOMY & DURABILITY FEATURES

Higher Productivity & Lower Fuel Consumption

New variable displacement hydraulic piston pump for reducing pressure loss, improvements in transmission and axles for improving energy saving, and the sophisticated electronic control of the engine operation to achieve optimal energy efficiency, all combined, realise maximum 5% better fuel consumption in the field compared with the GD655-5.

Fuel consumption maximum

5% reduction (P mode)
15% reduction (E mode)

(Compared with GD655-5)

Control Valve with Closed-centre Load Sensing System (CLSS)

Komatsu Multifunctional Control Valve with CLSS Hydraulic System enable the constant cylinder speed, excellent simultaneous operation ability, and fine control.

1) Low operating effort

Electronic Proportional Blade / **Ripper Controls**, these Finger Tip controls reduce operator hand / wrist movement by 98%.

NEW Significantly reduced operator fatigue.

2) Low operating effort

Palm Control or Standard Size **Steering Wheel** for Steering Function.

NEW Significant Safety Feature High Speed Road Travel.

3) Balanced flow

When the operator uses several controls at the same time, flow is proportional to ensure several implements can operate simultaneously.

4) Constant implement speed

Implement speed is constant regardless of engine speed because of the large pump output and proportional flow control function.

Auto Idle Stop Function

When the engine has been idling for certain time, the engine stops automatically to reduce unnecessary fuel consumption and exhaust emissions. The duration before the engine shutdown can be easily programmed.



Large Cooling Capacity

The arrangement of the cooling system is redesigned and the hydraulic driven cooling fan provides an air flow rate that is proportioned to cooling requirement, this reducing fuel consumption.

Longest Wheelbase & Short Turning Radius

The longest wheel base enables, a superior grading with a long blade. On the other hand, the turning radius is short, and provides excellent maneuverability.

Power on Demand

Normally, the variable displacement pump idles at low output. When it senses a load requirement, the pump supplies quick flow and pressure to match the demand. The result is less hydraulic system heat, quick response and lower fuel consumption.



PRODUCTION DURABILITY

Change in the Material of Circle Wear Plate to a Resin

The change to a resin prevents the scratches on the surface of the circle and provides the longer service life.

Rubber Clamps

Rubber clamps are used in many places to protect the hydraulic hoses.



Reinforced Blade Circle

Durability is improved by the increase in the circle's cross-sectional area, the addition of a drawbar reinforcing plate, and the adoption of a joint bar. Reliability is improved by the reinforced front frame and drawbar.



Double Seal Cylinder (Blade side shift cylinder)

A double-seal design is used for the blade side shift cylinder, which is installed near the ground, and thus susceptible to damage by dirt. Environmentally friendly by preventing oil leakage from the cylinder.

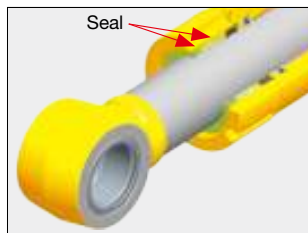

Blade Slide Screw Adjustment

Quick and Easy Adjustment **NEW**



OPERATOR ENVIRONMENT

All New Operator Station



**ELECTRONIC PROPORTIONAL CONTROLS BLADE & RIPPER
PALM CONTROLLED STEERING FUNCTION OR COVENTIONAL STEERING WHEEL
ELECTRONIC CONTROLLED OPERATOR ARM WRIST RESTS**

93% Reduction in Operator Hand Wrist Movement compared to previous models

The Future is at your Finger Tips

ROPS/FOPS Cab

Cab is low profile enclosed ROPS/FOPS.
(ISO 3471/ISO 3449)

The wide field of vision and roomy cab interior reduce operator fatigue.



Excellent Rear View

With excellent rearview visibility, an operator can easily check if the rear grading condition is safe for moving backward.



COMFORT

NEW Steering Wheel and Steering Lever

- Steering wheel for more safer travelling based on customer feedback
- Small diameter steering wheel has more controllability
- Steering lever on the left console enables the operator to steer the machine and control work equipment at the same time, without changing arm position



Blade & Front View

Hexangular cabin and control console layout, combined to make excellent visibility



More visibility to lifter lock pins due to refining control valve layout

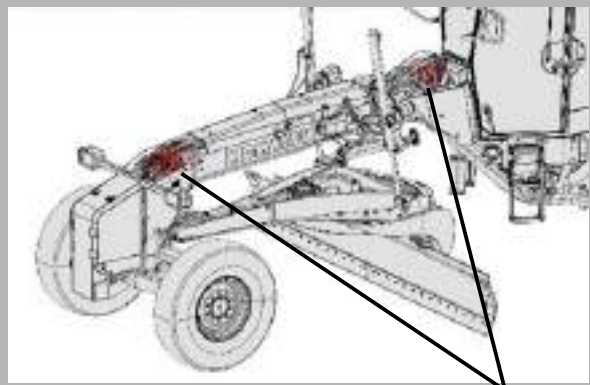

control valve

OPERATOR ENVIRONMENT



Air Suspension Seat

The suspension, fabric covered seat which is adjustable to the operator's weight is provided as standard. The suspension seat dampens vibrations transmitted from the machine and reduces operator fatigue. The seat features fold-up armrests and a retractable seat belt.

Air Conditioner

Well-positioned air conditioning vents keep the cab temperature comfortable regardless of the weather condition.

NEW



Standard Equipment

Lunch box tray



Cigarette lighter



Engine shutdown secondary switch



New transmission controls



Radio with Bluetooth & USB



Magazine box



Electronic Control Arm Rests



CROSS SLOPE CONTROL

Factory Option

#Note: All GD655-7 are fitted with Komatsu 2D "Ready" kits, effective from S/N 65120.

Limitation Komatsu 2D Cross Slope is not Expandable to 3D Hire Ready.

Controls



- 1) **Cross slope enable switch**
Activates all functions of cross slope control.
- 2) **Auto/Manual switch (Left side)**
- 3) **Auto/Manual switch (Right side)**
Activates left/right side of cross slope control.
- 4) **Slope match activation switch**
Set target slope to current blade slope angle.
- 5) **Preset 2 selection switch**
- 6) **Preset 1 selection switch**
Selects preset of target value from "SET 1"/"SET 2" preset.
- 7) **Target cross slope increase**
- 8) **Target cross slope decrease**
Adjusts target slope value up/down.

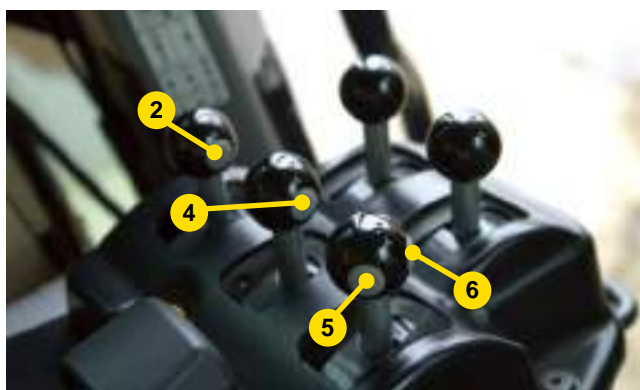

Indicators

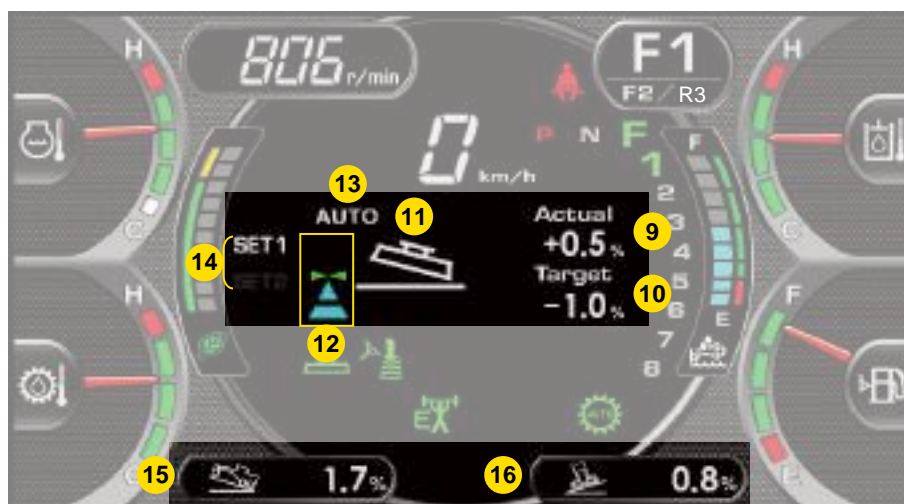

- 9) **Actual cross slope**
Indicates **current** cross slope angle in direction of machine travel.
- 10) **Target cross slope**
Indicates **desired** cross slope angle in direction of machine travel.
- 11) **Target slope status display**
Indicates direction of desired cross slope angle.
- 12) **Actual/Target slope difference indicator**
Indicates distinction between Actual/Target angle.
- 13) **Blade lift automatic control indicator**
Indicates active side of the blade for cross slope control.
- 14) **Preset indicator**
Indicates current preset of the target value from "SET 1" and "SET 2" preset.
- 15) **Mainfall slope**
Indicates longitudinal slope of the machine.
- 16) **Body slope**
Indicates cross slope of the machine.

COMFORT

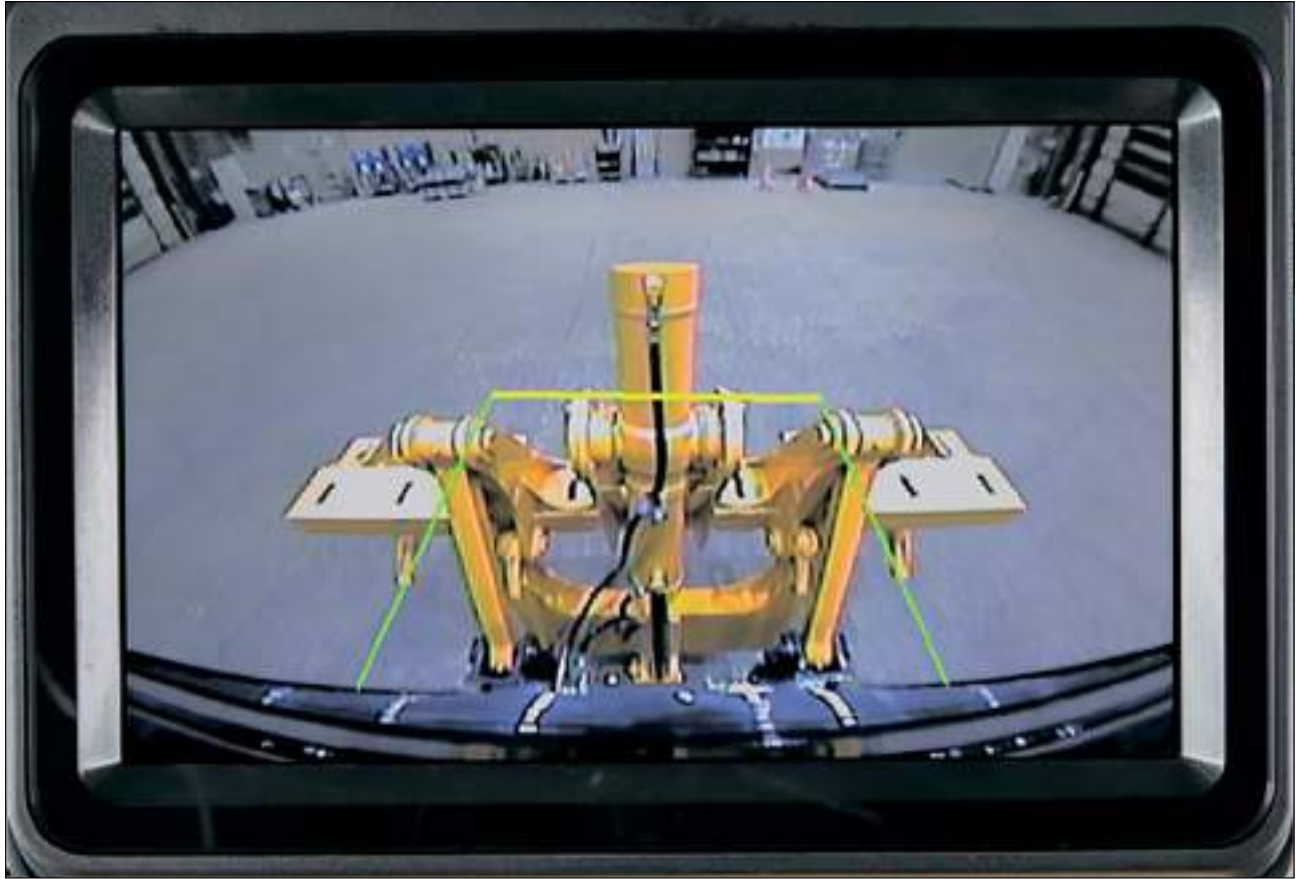

Excellent Rear Visibility

- Low and narrow engine hood reduces oppressive feeling of back view

Rear View Monitor & Camera

- Ensure visibility for rear end of the machine

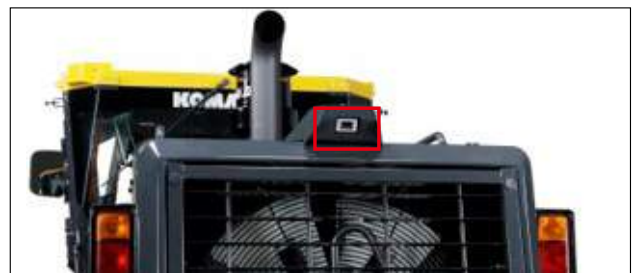

INFORMATION & COMMUNICATION TECHNOLOGY

Machine Monitor

The machine monitor display various machine information and allows for various settings of the machine. The Liquid Crystal Display (LCD) monitor is a 7-inch colour LCD and displays maintenance information, operation record, ECO guidance record, etc. The switch panel is used to select various screens. By using the switch panel, you can display various user menus on the LCD screen and adjust the machine settings.

Machine monitor

- | | |
|------------------------------------|--|
| ① LCD unit | ⑦ Hydraulic oil temperature gauge |
| ② LED unit | ⑧ Torque converter oil temperature gauge |
| ③ Speedometre | ⑨ Fuel gauge |
| ④ ECO gauge | ⑩ Message pilot lamp |
| ⑤ Shift indicator | ⑪ Pilot lamps |
| ⑥ Engine coolant temperature gauge | ⑫ DEF level gauge |

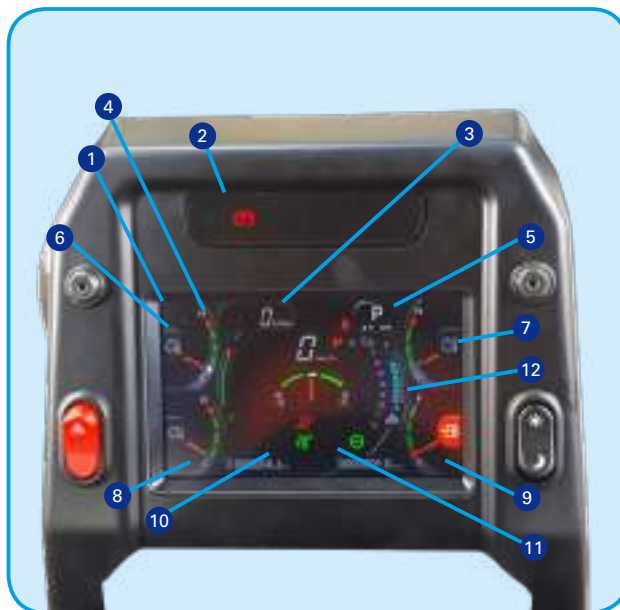

Visual user menu

Pressing the menu switch on the switch panel displays the user menu screen. The menus are grouped for each function, and use easy-to-understand icons which enable the machine to be operated intuitively.

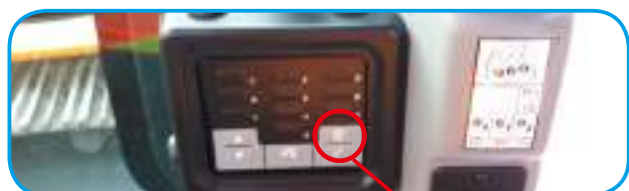

Menu switch

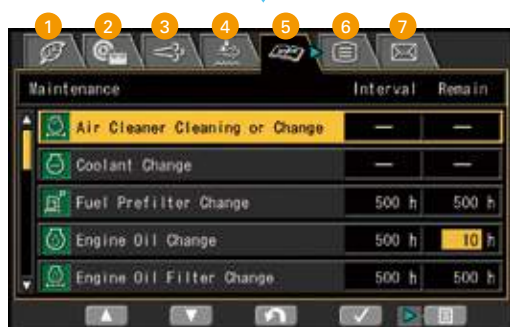

- ① Energy saving guidance
- ② Machine settings
- ③ Aftertreatment devices regeneration
- ④ SCR information
- ⑤ Maintenance
- ⑥ Monitor setting
- ⑦ Mail check

Operator ID function

An operator ID can be set for each operator and used to manage operation information of individual machines via KOMTRAX data. Data sent from KOMTRAX can be used to analyse operation status by operator as well as by machine.



Machine monitor with troubleshooting function to minimise downtime

Various metres, gauges and warning functions are centrally arranged on the machine monitor. The monitor simplifies startup inspection and promptly warns the operator with a lamp and buzzer if any abnormalities should occur. In addition, countermeasures are indicated in 4 levels to ensure safety and help prevent the machine from having major problems. Replacement times for oil and filters are also indicated.



Energy Saving Operation

ECO guidance

In order to optimum operation, the following 4 guidance messages are displayed for fuel saving operation

- 1) Excessive engine idling event
- 2) Excessive stepping on accelerator event
- 3) Recommendation of release acceleration at direction change.
- 4) Recommendation of shift up



ECO gauge

In order to help the operator to perform in an environmentally friendly way and minimise energy consumption, an easy-to-read "ECO gauge" is displayed on the machine monitor screen.

Operation record, fuel consumption history, and ECO guidance record

The ECO guidance menu enables the operator to check the operation record, fuel consumption history and ECO guidance record from the ECO guidance menu, using a single touch, thus enabling the total fuel consumption to be reduced.

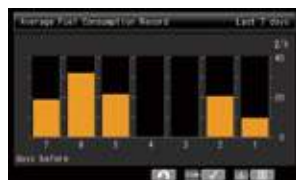
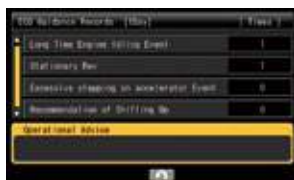

KOMTRAX

Assists Customer's Equipment Management and Contributes to Fuel Cost Cutting

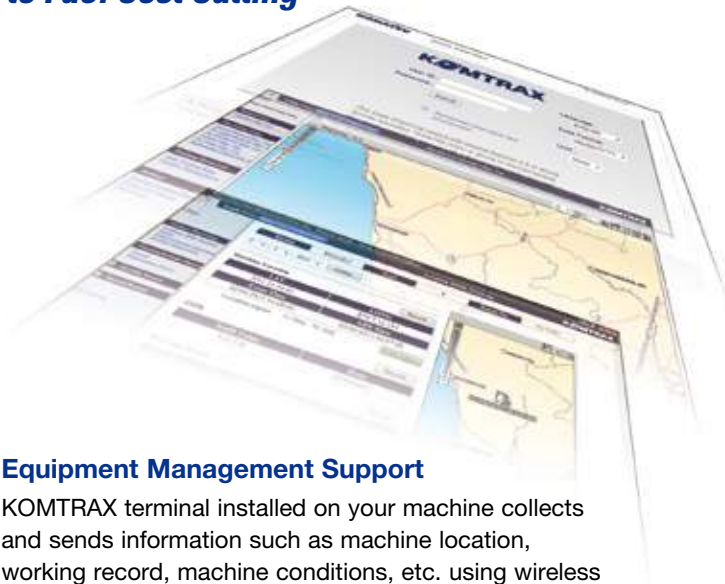

Equipment Management Support

KOMTRAX terminal installed on your machine collects and sends information such as machine location, working record, machine conditions, etc. using wireless communication. You can review the KOMTRAX data remotely via the online application. KOMTRAX not only gives you the power of knowledge on your machine, but also the convenience of managing your fleet on the web. In addition to existing items, the following new information is provided.

- DEF consumption logs
- Operation information of each operator for operator identification function

Energy-saving Operation Support Report

KOMTRAX provides various useful information which includes the energy-saving operation support report based on the operating information of your machine such as fuel consumption and idle time.



MAINTENANCE FEATURES



Easy Access to Service Areas

- Large hinged lockable doors are standard and provide easy access to the engine and radiator service points. Spin-on filters can be changed quickly.
- The fuse panel is located in the cab. Circuits and fuse sizes are clearly identified.
- The tandem oil check point is conveniently located at the end of the tandem.
- Refueling from the ground is easy.
- Engine oil, hydraulic oil and coolant drains are in the place maintained easily.
- The tandem axle step is provided with a punched metal foot plate to ensure safety during maintenance and inspection. Also, this machine is considered to safe getting on and off.



Ground refueling



Battery Disconnect Switch

For inspection and maintenance, the batteries can be disconnected with this switch when repairing the machine or checking batteries.



Easy Access DEF Tank

Located at the right rear side of radiator grille, for easy to access. A convenient sight gauge is provided.



Maintenance Information

“Maintenance time caution lamp” display

When the remaining time to maintenance becomes less than 30 hours*, the maintenance time monitor appears. Pressing the menu switch the monitor to the maintenance screen.

* : The setting can be changed within the range between 10 and 200 hours.



Maintenance screen

Aftertreatment devices regeneration automatic display

When it is necessary to carry out manual regeneration (the manual stationary regeneration) of the KDPF, the display automatically switches to the aftertreatment device regeneration screen to inform the operator.

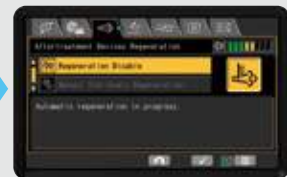

Aftertreatment device regeneration screen

Supports the DEF level and refill timing

The DEF level gauge is displayed continuously on the right side of the monitor screen. In addition, when the refill timing* is reached, the DEF low level guidance appears as a pops up display to inform the operator in real time.

* : The 2014 standard covering specific special automobile exhaust gases stipulates that when the DEF level becomes very low, the engine output is limited by law.



DEF level gauge



DEF low level guidance

SPECIFICATIONS



ENGINE

Model Komatsu SAA6D107E-3 Final Tier 4 Emission
 Type Water-cooled, 4-cycle, direct injection
 Aspiration Turbocharged, aftercooled, cooled EGR
 Number of cylinders 6
 Bore 107 mm
 Stroke 124 mm
 Piston displacement 6.69 L
 Gross horsepower (Manual mode)
 P-mode
 Gear 1-3 137 kW 183 HP / 2000 min⁻¹
 Gear 4-6 151 kW 203 HP / 2000 min⁻¹
 Gear 7-8 165 kW 221 HP / 2100 min⁻¹
 E-mode
 Gear 1-6 137 kW 183 HP / 2000 min⁻¹
 Gear 7-8 165 kW 221 HP / 2100 min⁻¹
 Net horsepower (Manual mode)
 P-mode
 Gear 1-3 135 kW 180 HP / 2000 min⁻¹
 Gear 4-6 150 kW 200 HP / 2000 min⁻¹
 Gear 7-8 163 kW 218 HP / 2100 min⁻¹
 E-mode
 Gear 1-6 135 kW 180 HP / 2000 min⁻¹
 Gear 7-8 163 kW 218 HP / 2100 min⁻¹
 Max. torque 941N·m 96.0 kg·m / 1450 min⁻¹
 Torque rise 30 %
 Fan speed Max. 1450 min⁻¹
 Air cleaner 2-stage, dry-type
 * Net horsepower output for standard (SAE J1349) including air cleaner, alternator (not charging), water pump, lubricating oil, fuel pump, muffler and fan running at minimum speed.

U.S. EPA Tier 4 Final and EU Stage 4 emissions certified.



TRANSMISSION AND TORQUE CONVERTER

Full power shift transmission with integral free wheeling stator torque converter and lock-up.

Speeds (at rated engine speed)

Gear	Forward	Reverse
1st	3.4 km/h	4.5 km/h
2nd	5.0 km/h	9.2 km/h
3rd	7.0 km/h	20.3 km/h
4th	10.2 km/h	40.3 km/h
5th	15.4 km/h	-
6th	22.3 km/h	-
7th	30.6 km/h	-
8th	44.3 km/h	-



TANDEM DRIVE

Oscillating welded box section 520 mm x 202 mm
 Side wall thickness: Inner 22 mm
 Outer 19 mm
 Wheel axle spacing 1525 mm
 Tandem oscillation 11° forward, 13° reverse



FRONT AXLE

Type Solid bar construction welded steel sections
 Ground clearance at pivot 620 mm
 Wheel lean angle, right or left 16°
 Oscillation, total 32°



REAR AXLE

Alloy steel, heat treated, full floating axle with lock/unlock differential.



WHEELS, FRONT AND REAR

Bearings Tapered roller
 Tyres 17.5xR25, Tubeless
 Tyre rims (demountable) 14" three-piece rims



STEERING

Hydraulic power steering providing stopped engine steering meeting ISO 5010.
 Minimum turning radius 7.4 m
 Maximum steering range, right or left 49°
 Articulation 25°



BRAKES

Service Brake. Foot operated, sealed oil disc brakes, hydraulically actuated on four tandem wheels
Parking Brake. Manually actuated, spring applied, hydraulically released caliper



FRAME

Front Frame Structure
 Height 300 mm
 Width 300 mm
 Side 16 / 32 mm
 Upper, Lower 25 mm



DRAWBAR

A-shaped, u-section press formed and welded construction for maximum strength with a replaceable drawbar ball.
 Drawbar frame 210 x 22 mm



CIRCLE

Single piece rolled ring forging. Six circle support shoes with replaceable wear surface. Circle teeth hardened on front 180° of circle.

- Diametre (outside) 1530 mm
- Circle reversing control hydraulic rotation 360°



MOLDBOARD

Hydraulic power shift fabricated from high carbon steel. Includes replaceable metal wear inserts, cutting edge and end bits. Cutting edge and end bits are hardened.

- Dimensions 4230 x 660 x 25 mm
- Arc radius 432 mm
- Cutting edge 152 x 16 mm
- Replaceable/Reversible side edges 156 x16 x456 mm
- Blade Pull
 - Base GVM with ripper 12607 kg
 - Maximum GVM with ripper 14697 kg
- Down Pressure
 - Base GVM with ripper 9491 kg
 - Maximum GVM with ripper 11066 kg
- Blade pull calculated at 0.9 traction coefficient, which is equal to no-slip conditions and gross machine weight.



BLADE RANGE

- Moldboard side shift:
 - Right 820 mm
 - Left 820 mm
- Maximum shoulder reach outside rear tyres (frame straight)
 - Right 2000 mm
 - Left 2000 mm
- Maximum lift above ground 480 mm
- Maximum cutting depth 615 mm
- Maximum blade angle, right or left 90°
- Blade tip angle 40° forward, 5° backward



HYDRAULICS

Load-sensing closed centre hydraulics with variable displacement piston pump. Electronic Proportional Blade Control reduced operator hand wrist control valves with preselected maximum flow setting to each function. Double acting anti-drift check valves on blade lift, tip, circle shift, articulation, and leaning wheels.

- Output (at engine rated rpm). 200 L/min
- Standby pressure 3.4 MPa 35 kg/cm²
- Maximum system pressure 20.6 MPa 210 kg/cm²



INSTRUMENT

Electric monitoring system with diagnostics:

- Gauges:
 - Standard . . . articulation, engine coolant temperature, fuel level, speedometre transmission shift indicator, engine tachometre, torque converter oil temperature

Warning lights/Indicator:

- Standard . . . battery charge, brake oil pressure, blade float, brake oil pressure, inching temperature, directional indicator, engine oil pressure, hydraulic oil temperature, heater signal, lift arm lock, parking brake, differential lock, torque converter oil temperature, eco, P mode, fan reverse, rpm set, high beam, working lights



CAPACITIES (REFILLING)

- Fuel tank 390 L
- DEF tank 37 L
- Cooling system 30 L
- Crank case 23 L
- Transmission 45 L
- Final drive 17 L
- Tandem housing (each) 57 L
- Hydraulic system 69 L
- Circle reverse housing 7 L



OPERATING WEIGHT (APPROXIMATE)

- Includes lubricants, coolant, full fuel tank.
- With rear mounted ripper and front push plate:
 - Total 19730 kg
 - On rear wheels 14008 kg
 - On front wheels 5722 kg
- Fitted with 17.5 x R25 tyres & rims



RIPPER

- Ripping depth, maximum 425 mm
- Ripper shank holders 5
- Ripper shank holder spacing 534 mm
- Penetration force. 9390 kg
- Pryout force. 17600 kg
- Machine length increase, beam raised. 690 mm



REAR SCARIFIER

- Rear
 - Working width 2186 mm
 - Scarifying depth, maximum 165 mm
 - Scarifier shank holders 9
 - Scarifier shank holders spacing 267 mm



DIMENSIONS

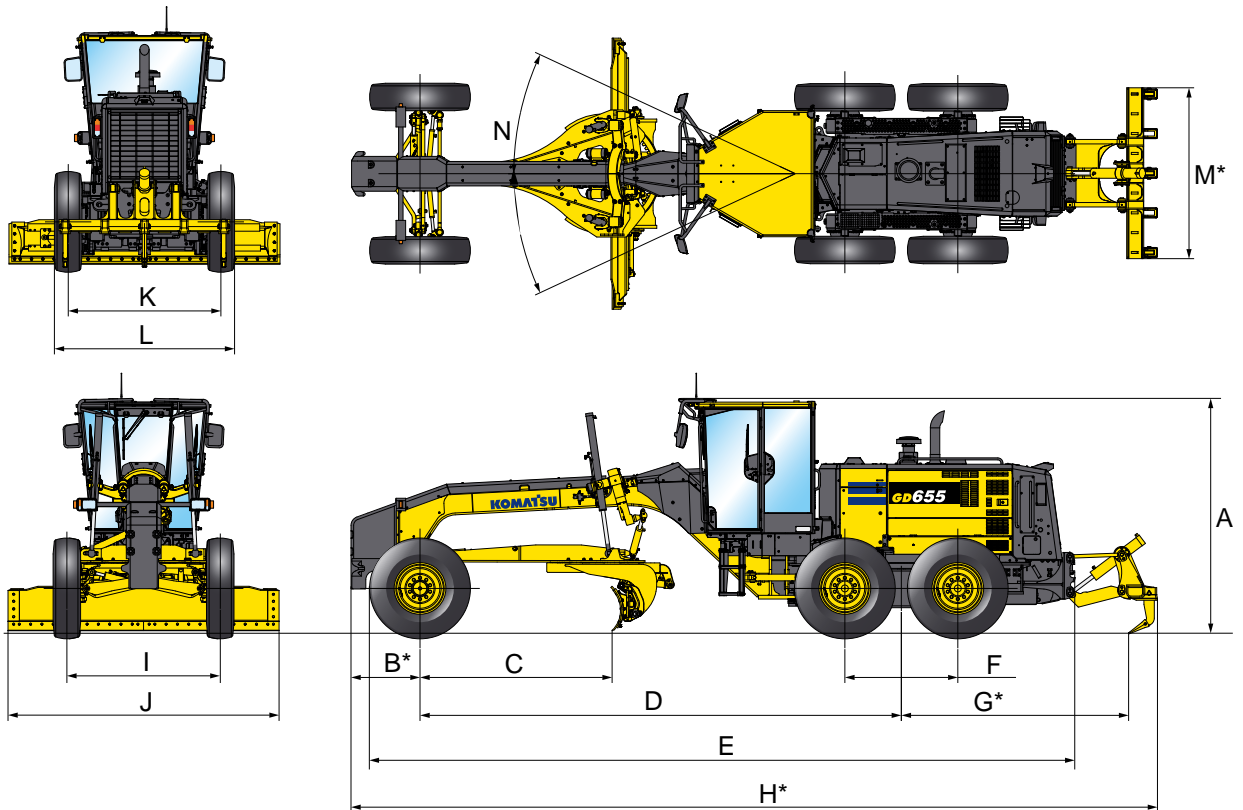

A	Height: Low profile cab	3200 mm
B*	Centre of front axle to counterweight (Pusher)	930 mm
C	Cutting edge to centre of front axle	2580 mm
D	Wheelbase to centre of tandem	6495 mm
E	Front tyre to rear bumper	9510 mm
F	Tandem wheelbase	1525 mm
G*	Centre of tandem to back of ripper	3065 mm
H*	Overall length	10875 mm
I	Tread (front)	2070 mm
J	Width of standard moldboard	4320 mm
K	Tread (rear)	2060 mm
L	Width over tyres	2680 mm
M*	Ripper beam width	2305 mm
N	Articulation, left or right	25°

*optional



STANDARD EQUIPMENT

ENGINE AND RELATED ITEM

- Engine: Komatsu SAA6D107E-3, EPA Tier-4 Final and EU Stage 4 Certified
- Turbocharged and Air Aftercooled
- Variable Horse Power Net 135Kw – 163Kw
- Double Element Air Cleaner and Dust Indicator
- Air Intake Extension
- Pre-Cleaner, Turbo II
- Fuel Line Pre-Filter
- Hydraulic Reversing Fan
- Hood-Sides for Engine Compartment

ELECTRICAL SYSTEM

- KOMTRAX Total Fleet Management Tool
- Alarm Backup
- Alternator 24volt 140Amp
- Battery 2x12V 140Ah
- Battery Disconnect Switch
- Dome Light Cabin
- Horn Electric
- Indicators, Parking Brake, Differential lock, Blade Float, Lift Arm Locks, High Beam, Eco Engine, Engine P Mode, Cooling Fan Reverse, RPM Set, Oil Pressure, Battery Charge, Brake Oil Pressure, Differential Oil Temperature
- Lights Back-Up, Stop, Tail, Directional, headlights (2 halogen type, front mounted bar)
- Work Lamps Front (4) Rear (2)
- Cab Mount Work Lamps (4)
- Dual Roof Mounted LED Beacons with Guards
- Multi-Colour monitor
- Rear View Monitor and Camera

OPERATOR ENVIRONMENT

- Cab Low Profile Enclosed ROPS/FOPS (ISO3471/ISO3449) with Safety Tinted Glass Windows with Wipers & Washers
- Air conditioner R134a
- Console, Adjustable with Instrument Panel Monitoring System
- Monitor Includes, LCD Unit, LED Unit, Speedometer, ECO Gauge, Shift Indicator, Engine Coolant Temperature, Hydraulic Oil Temperature Gauge, Torque Converter oil temperature Gauge, Fuel Gauge, Message Pilot Lamp, Pilot Lamps, DEF Level Gauge
- Seat Air Suspension (150Kgs Capacity) Deluxe Adjustable Cloth with Canvas Seat Cover and retractable Seat Belt
- AM/FM Radio with Bluetooth & USB Communications
- Mirrors, Interior Cab, RH & LH External Mirrors
- Sound Suppression, Cab and Floor Mat
- Wipers Front, Doors and Rear Window
- 2 x DC12V electrical Outlets /1 12volt (10A) Power Point

POWER TRAIN

- Axle, rear full floating, planetary type
- Brake, Parking spring applied hydraulic released, disc type
- Differential lock/unlock
- Dual mode transmission (F8-R4) powershift direct drive and torque convertor with auto shift, engine stall prevention function
- Service Brakes, fully hydraulic wet disc
- Tyres and Rims 17.5x R25 Tubeless Radials tyres on 14inch Rims

- Circle, Draw Bar mounted 360deg Rotation, Hydraulic Blade Lift and Circle Side Shift
- Circle Slip Clutch
- Hydraulic System, Closed Center, Load Sensing
- Accumulators, Anti-Shock for Blade Lift
- Komatsu 2D Cross Slope "Ready" kit
- Moldboard 4320mm x 660mm x 25mm
- Hydraulic Blade Side Shift and Hydraulic Tilt with Anti-Drift Check Valves
- Maximum Moldboard Angle Position 90degs Right & Left
- Steering, Full Hydraulic with Tilt Steering Wheel, Pus Leaning Front Wheels
- Frame articulation with Anti-Drift Valves and Articulation Return to Center
- 10 Section Hydraulic Control Valve
- Blade Lift Float Detent Style, LH & RH
- Ripper Assembly Rear Mounted
- Supplied with 3 Ripper Tynes with provision for 2 Additional Tynes & 9 Scarifier Tynes

OTHER STANDARD EQUIPMENT

- Painting, Komatsu Standard Colour Scheme
- Steps and Handrails, Rear, Right and Left Hand Side
- Vandalism Protection Includes Lockable Access to fuel Tank, Battery Cover and Engine Side Covers
- Tool Box with Lock on Tandems
- Tool box with lock on Y Frame
- Fuel Tank Ground Level Access
- Push Plate
- Front Steering Cylinder Guards

WORK EQUIPMENT & HYDRAULICS



OPTIONAL EQUIPMENT

BLADES

- Moldboard: 3710 mm x 645 mm x 22 mm
- Moldboard Overlays
- Spare Cutting Edge Carrier
- Front Blade Lift or Lift & Tilt

TYRES & RIMS

- Tyres: 14.00-24 Radial on 3 Piece 10" Rims (Width 2,490 Mm; deduct 100 Kg for 6 Tyres and Rims)

SPARE TYRES & RIMS

- Spare Tyre Carrier Side Mount Rear – Hydraulic Raise Lower

CABIN

- Komatsu 2D Cross Slope
- Hinged Rear-view Side Mirrors
- Rear Window Internal Roll Up Blind
- Cabin Pressuriser for Severe Applications»
- Cabin External Air Conditioning Filtration for Severe Applications»

OTHERS

- Tow Hitch Various Options
- Auto Lube Systems Various Options
- Lighting Package Protection
- Over Dimension Signage
- Hand Wash Dispenser
- **Machine Control Options**
GD655-7 can be fitted with all leading types of 2D & 3D machine controls including Topcon, Trimble, Leica. Other brands please discuss with your Komatsu Sales Account Manager.

GD655-7

www.Komatsu.com.au

Printed in Australia

KOMATSU[®]

Form No: ZESS006500_NOV2020

Materials and specifications are subject to change without notice.
KOMATSU is a trademark of Komatsu Ltd. Japan.