

KOMATSU

WA475-10

EPA Tier 4 Final Engine
Australia and New Zealand Specifications



Photo shows overseas model.

Wheel loader

NET Horsepower
290 HP @ 1600 rpm
216 kW @ 1600 rpm

Operating weight
26,660 kg

Bucket capacity
3.8 – 6.4 m³



NET Horsepower

290 HP @ 1600 rpm
216 kW @ 1600 rpm

Operating weight

26,340 - 27,410 kg

Bucket capacity

3.8 - 6.4 m³

Photos may include optional equipment.

Performance, durability and fuel economy

- New KHMT Transmission

Komatsu SmartLoader Logic helps reduce fuel consumption with no decrease in production.

A powerful Komatsu SAA6D125E-7 engine

provides a net output of 216 kW 290 HP with 17% improved fuel consumption. This engine is EPA Tier 4 Final emissions certified.

Variable Geometry Turbocharger (VGT) uses a hydraulic actuator to provide optimum air flow under all speed and load conditions.

Komatsu Diesel Particulate Filter (KDPF) and Selective Catalytic Reduction (SCR) systems reduce particulate matter and NOx while providing automatic regeneration that does not interfere with daily operation.

Variable displacement piston pumps with CLSS provides quick response and smooth operation to maximise productivity.

Rearview monitoring system (standard)

Advanced diagnostic system continuously monitors machine operation and vital systems to identify machine issues and assist with troubleshooting.

Cooling

- Hydraulically driven, variable speed
- Auto-reversing fan is standard
- Wider core coolers resist clogging
- Swing out fan for easy cleaning

Remote boom and bucket positioners can set kick-outs from inside the cab.

Economy and Productivity

- Komatsu Hydraulic Mechanical Transmission (KHMT)
- Optimised control system of KHMT
- 8% increase in breakout force
- 20% increase in boom lift force
- New bucket design

Easy Operation

- Independent work equipment control
- Travel speed control dial
- Auto hill holding function
- Automatic digging system



Operator Environment

- Large front and rear glass with high visibility
- New 5-way adjustable console
- Command selector for intuitive monitor operation
- User interface preferred switch layout
- Powered adjustable rearview mirror with heater

Easy Maintenance

- Powered tiltable engine hood
- Engine hood side covers for daily maintenance
- Improved maintainability of components

Convenience Features

- Tie-offs
- LED headlamps and work equipment lights

Ecology

- Komatsu's proven U.S. EPA Tier 4 Final emission regulations-compliant engine

Durability and Reliability

- High reliability Komatsu components

Information and Communication Technology (ICT)

- Komtrax®

Komatsu Auto Idle Shutdown helps reduce idle time and operating costs.

*Compared to the WA480-6.

Performance features

Komatsu new engine technologies

New Tier 4 Final Engine

The Komatsu SAA6D125E-7 engine is EPA Tier 4 Final emissions certified and provides exceptional performance while reducing fuel consumption. It is based on Komatsu proprietary technologies developed over many years.

Technologies applied to new engine

Heavy-duty aftertreatment system

This new system combines a Komatsu Diesel Particulate Filter (KDPF) and Selective Catalytic Reduction (SCR). The SCR NOx reduction system injects the correct amount of Diesel Exhaust Fluid (DEF) at the proper rate, thereby decomposing NOx into non-toxic water vapor (H₂O) and nitrogen gas (N₂).

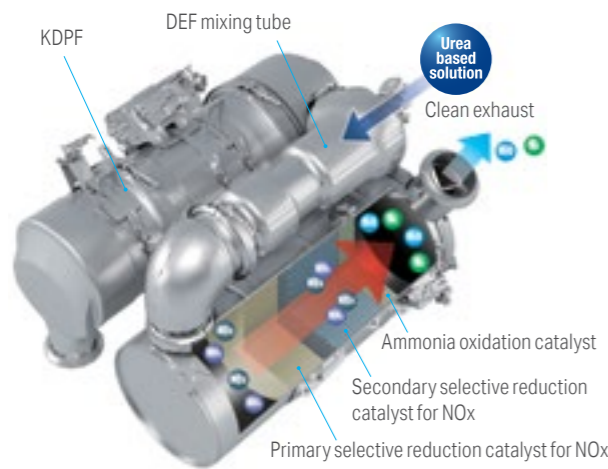

Heavy-duty cooled Exhaust Gas Recirculation (EGR) system

The system recirculates a portion of exhaust gas into air intake and lowers combustion temperatures, thereby reducing NOx emissions. Furthermore, while

EGR gas flow is increased, by incorporating a high-efficiency and compactly designed cooling system, the system achieves a dynamic reduction of NOx, while helping reduce fuel consumption.

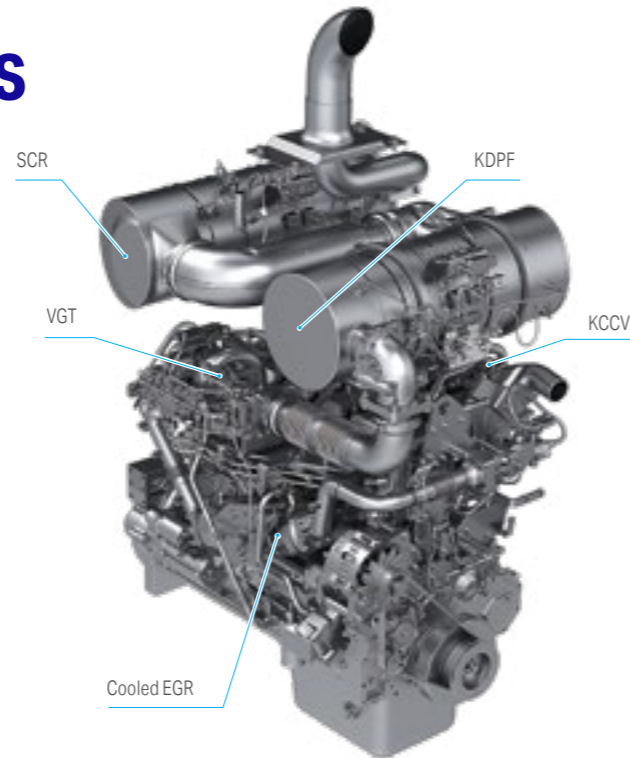
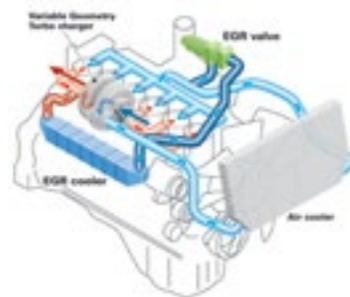

Advanced Electronic Control System

The electronic control system performs high-speed processing of all signals from sensors installed in the vehicle providing total control of equipment. Engine condition information is displayed on the monitor inside the cab, providing necessary information to the operator. Additionally, managing the information via Komtrax helps customers keep up with required maintenance.

Komatsu smart loader logic

The WA475-10 provides Komatsu Smart Loader Logic, an engine control system. This technology creates enough torque for each work phase. For example, engine torque needs are higher for digging in V-shape loading, but less when driving with an empty bucket. This system optimises the engine torque for all applications to minimise fuel consumption. Komatsu Smart Loader Logic functions automatically and doesn't interfere with operation, saving fuel without decreasing production.

Komatsu auto idle shutdown

In order to reduce idle time, Komatsu offers Komatsu Auto Idle Shutdown. This function will shut the engine off and apply the parking brake and hydraulic lock after a preset idle time limit. This time limit can be set by the operator or service technician and may range from 3 minutes to 60 minutes.

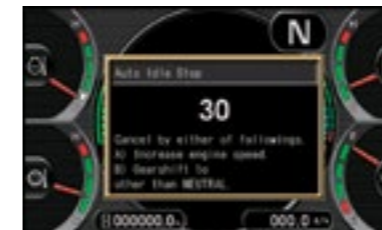

Variable Geometry Turbocharger (VGT) system

The VGT system features proven Komatsu design hydraulic technology for variable control of air-flow and supplies optimal air according to load conditions. The upgraded version provides better exhaust temperature management.

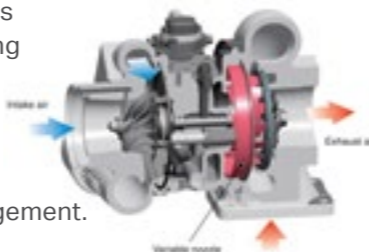

Heavy-duty High-Pressure Common Rail (HPCR) fuel injection system

The system is designed to achieve an optimal injection of high-pressure fuel digitally, thereby bringing near complete combustion to reduce PM emissions.

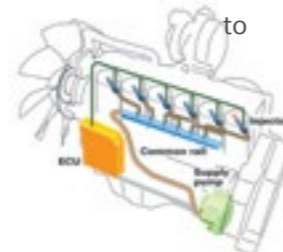

Dual-mode engine power select system

This wheel loader offers two selectable operating modes — Economy and Power.

- Achieve low fuel consumption E mode suppresses wasteful acceleration, while maintaining the same bucket fill rates and climbing speed.
- Bucket filling rate is same as P mode When digging, rim pull force is automatically adjusted to provide sufficient rim pull force so the bucket filling rate is the same as it would be in P mode.
- Climbing speed is same as P mode When driving, if a decrease in acceleration is detected, the rim pull force will automatically and smoothly change so max vehicle speed will be the same as it would be in P mode.



Variable displacement piston pump and CLSS

The variable displacement piston pump combined with the Closed-centre Load Sensing System (CLSS) delivers hydraulic flow just as the job requires preventing wasted hydraulic flow. Minimised loss contributes to better fuel economy.

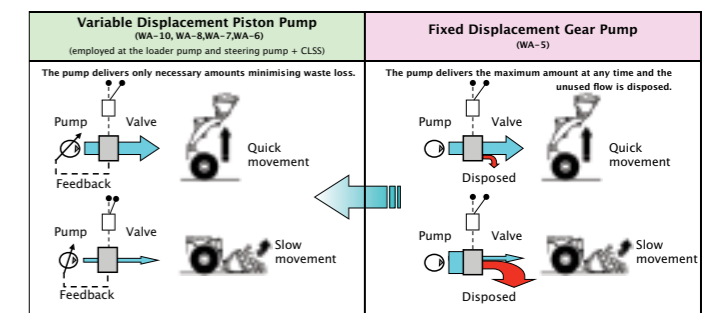

Performance features

Komatsu Hydraulic Mechanical Transmission (KHMT)

Fuel economy is greatly improved with the KHMT without losing productivity.

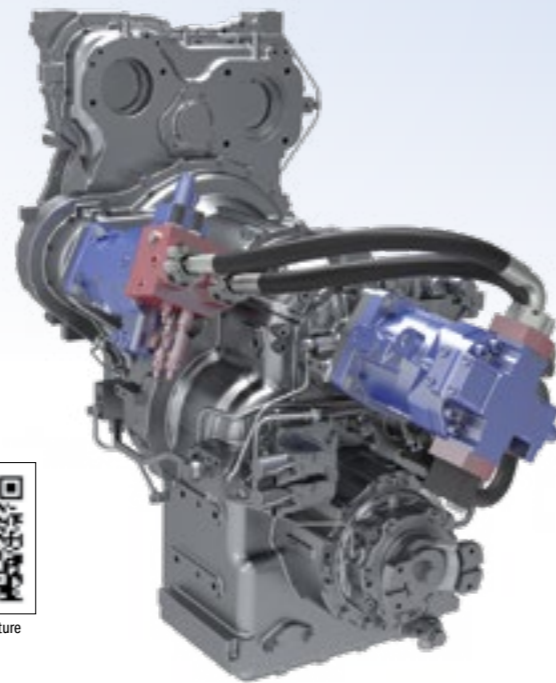

Fuel efficiency (tons/litre)

Increased by up to **30%**

* Compared with WA470-8.



Movie for this feature

New bucket design

The newly designed bucket helps to improve overall machine productivity. Generous curves on the side wall and wrap improve pile penetration and make it easy to fill. Material retention is improved in carry operations.

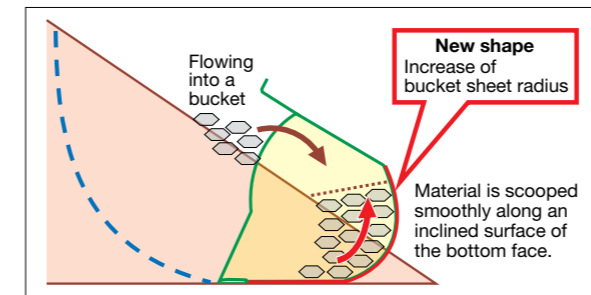

Breakout force (by lift cylinder)

The breakout force has increased by 20% compared to the WA470-8. This performance improvement further enhances productivity.

Breakout Force (by Lift Cylinder)

Up to + 20%



Helps eliminate waste and improve efficiency

- High-performance load meter new feature
- Load meter accuracy has been improved with more convenient functionality
- Automatic measurement function
- Weight in the bucket can be taken by simply pressing a switch.
- Dump monitoring
- Allows for real time monitoring of the weight of any material in the bucket after dumping.
- Easy
- Calibration can be done with onsite materials and truck scale. Empty bucket calibration can be done anytime. Dedicated weight for calibration is no longer needed.

Optimised control system of KHMT

The control system of the KHMT comprehensively judges the machine condition and the loads during operation. It controls the engine speed, and the distribution of engine power automatically to promote optimised acceleration, traction and power for the work equipment, while maintaining a lower, more constant engine speed. In addition, an operator can control the machine intuitively and help achieve optimal operation easily. As a result, the WA475-10 has high productivity, low fuel consumption and helps reduce operator fatigue.

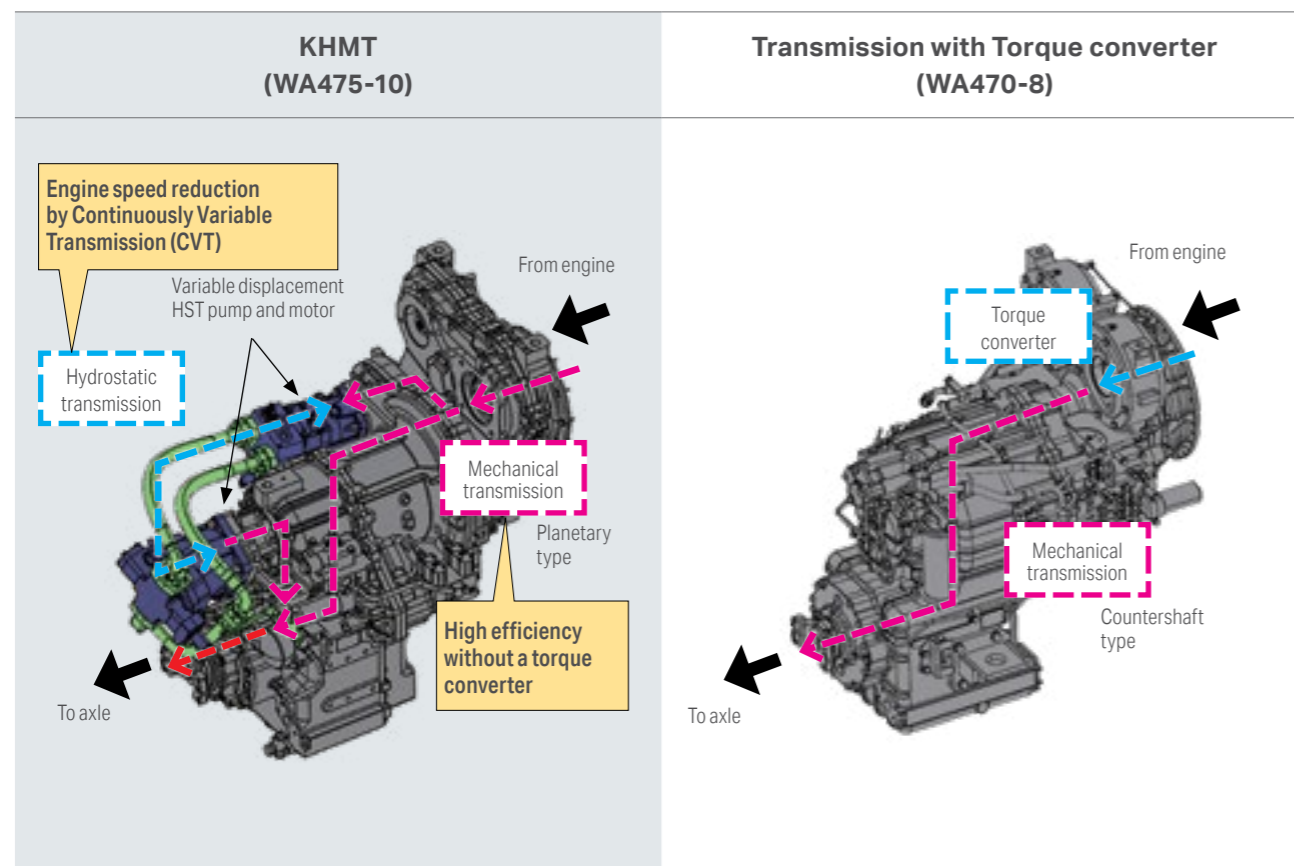
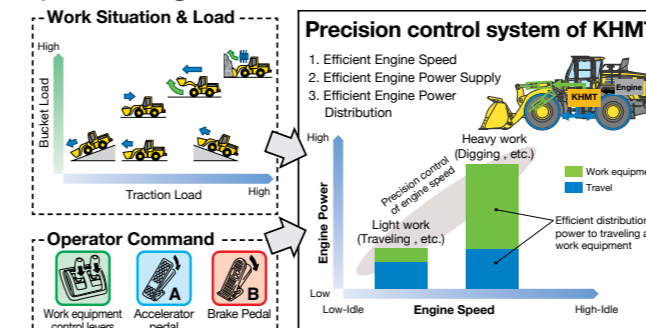

Easy operation

Independent work equipment control

Simple Operation for Work Equipment

The operator no longer needs to use the accelerator to speed up the work equipment controls. The work equipment speed is now controlled with the levers only.

- Work equipment control levers







- Accelerator pedal

















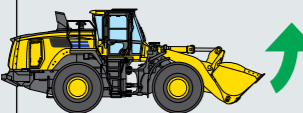
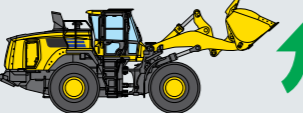







- Brake pedal



Operation	Raise work equipment 
WA475-10	Only operation of work equipment control levers  Control speed by lever angle
Conventional model	Combined operation of work equipment   Control work equipment speed by accelerator

Easy Approach

Since operator can control work equipment speed only with levers, they can easily operate work equipment and travel. Operator can easily approach dump truck with no dragging of the brake, thus fuel economy is improved.

Operation	Start raising work equipment	Simultaneously operate work equipment and travel system	Approach dump truck
Work equipment operation	 Easy operation 	 	
WA475-10			
Travel operation	Fuel economy is improved due to no dragging of brake.	 Brake is used to decelerate and stop	
Work equipment operation	  Combined operation of levers and accelerator to increase work equipment speed  	 	 
Conventional model			
Travel operation	Combined operation of brake and accelerator  		

Travel speed control dial

The operator can control max. travel speed with travel speed control dial. It makes various operations such as V-shape, travel on level ground and downhill easier.



Movie for this feature

- When traveling downhill
The operator can control the downhill travel speed with the dial. Load spillage is reduced by smooth deceleration. Axle overheating is also prevented because of the reduced need for using the brake pedal.

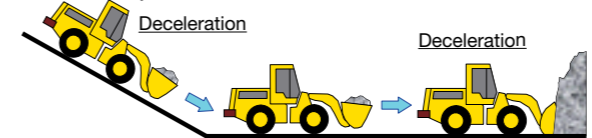

Auto hill holding function

This function prevents the machine from rolling back on uphill applications such as stock piling operation even if the operator does not apply the brake pedal. It makes operation easier and the operator is less fatigued.



Automatic digging system

The automatic digging system actuates the bucket tilt and lifting operations by detecting the sensing pressure applied to the work equipment. This system can alleviate operator fatigue and realise the ideal load capacity. The ON/OFF changeover can be done on the R.H. front switch panel easily.

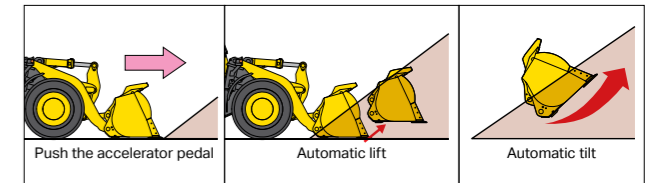

Max. traction switch

Even when the traction control is ON, the operator can increase the rim pull simply by pressing the Max. Traction Switch. The rim pull can be controlled easily during operation.

Max. Traction Switch



Remote bucket and boom positioner with shockless stop function

The operator can set the bucket angle and remote boom positioner from the cab. Once the positioner is set, the bucket is smoothly stopped at the desired position with less shock.

Electronically Controlled Suspension System

The Electronically Controlled Suspension System (ECSS) or ride control system uses an accumulator which absorbs some of the shock in the boom arm, giving the operator a much smoother ride. This reduces operator fatigue and reduces material spillage during load-and-carry operations.

Operator environment



Newly designed cab

A pressurized, large, four-post cab provides a quiet operator environment with impressive visibility. Visibility is improved by adding a lower glass area and eliminating the rear pillars. This contributes to comfortable operation together with the newly designed console. In addition, the outside air intake type, fully automatic, large-capacity air conditioner is installed as standard, keeping the inside of the cab comfortable all year round.

Exceptional visibility

The interior is newly designed and a glass area is added to the lower position of the front corner of the cab and side door. The areas around the wheels can now be visually checked easily.



5-way adjustable console and integrated switches

To suit various types of operator posture during operation, the following have been added: console tilt, armrest tilt, armrest swing, as well as fore/aft and armrest height has been added. Switches for frequent use during operation (Horn Switch, Parking Brake Switch, Travel Speed Control Dial, Air Conditioner Switch, Working Lamp Switch, Directional Selector Switch, etc.) are integrated into R.H. console and front pillar. The operator can access these switches without changing posture.

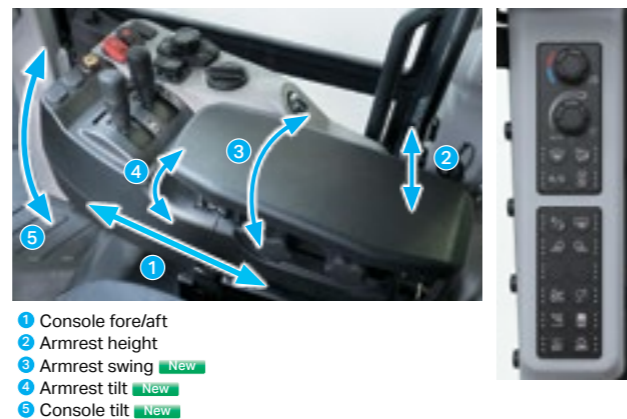

Command Selector

Command selector makes user menu control intuitive. Frequent access can be registered to the shortcut switch.



New operator seat

The operator seat dampens vibrations from the machine, and provides a comfortable ride for the operator. In addition, the operator is less fatigued after long hours of operation thanks to the seat adjustment function which can be customized to the operator.



Advanced Joystick Steering System (AJSS)

Minimise operator fatigue with the advanced joystick steering system (AJSS) that provides precise wrist and finger steering and control, even during full speed travel.



Storage space, AUX and power outlet (R.H.)

- Smartphone holder with USB Charging Port
- Various connectors
 - 1 AUX
 - 2 12V
 - 3 USB
- Storage space (Operation and Maintenance Manual pocket, magazine rack, tray)



Large utility space (L.H.)

A multi-purpose space is provided on the left side of the seat, featuring a drink holder and an area for a large cooler box on the floor.



Multifunction audio

The cab is equipped with an AM/FM radio with AUX, USB and Bluetooth® wireless technology.

Electric mirror with heater

Electric mirrors can be adjusted with a switch in the cab.

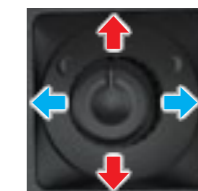

Maintenance features



Powered tiltable engine hood

The engine hood can be opened and closed using an electric motor switch. The engine compartment is greatly improved and easy to maintain. The hood control switch is located near the battery box on the left side of machine.



Swing-out Type Cooling Fan

Swing out type hydraulic cooling fan can be opened and closed with a single touch. The radiator can be cleaned from rear as well.

Auto reversing fan

The engine cooling fan is driven hydraulically. It can be set to reverse automatically during operation. Fan reverse mode and timing can be controlled through the monitor.

Easy window cleaning

Wide steps, a roof handrail and tie-off points are installed to provide easy window cleaning.



Anchor point of Tie-off



Steps



Roof handrail

Downtime reduction

The aftertreatment devices and engine can be easily replaced by opening the engine hood. In addition, the cab can be easily replaced as well.

From R.H. side of machine

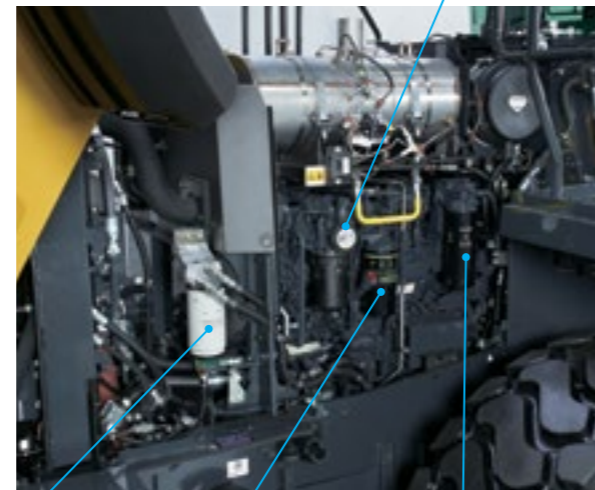

Fuel Prefilter * Fuel filter Engine oil filter

* Replaceable from engine hood side cover

Komatsu Closed Crankcase Ventilation (KCCV)

Engine hood side covers

The operator can access engine areas that are serviced every day from the engine R.H. and L.H. hood side covers. The side-by-side type radiator can be easily cleaned.



Air cleaner

The air cleaner is located on the right side platform for easy access.



Battery disconnect switch

The battery disconnect switch is located in the right side of the engine. This can be used to disconnect power when performing service work on the machine. This switch can be locked out by using a lock out hasp.



DEF tank

The DEF tank is located on the right hand side of the machine behind a ladder for easy access. The inside of the cover has a holder for the DEF tank cap.



Maintenance Information

Maintenance time display



Aftertreatment devices regeneration display

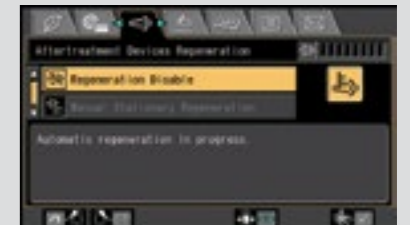

Supports the DEF level and refill timing

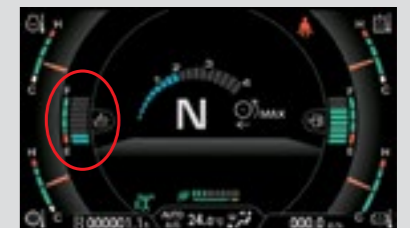

Durability and reliability

Komatsu components

Komatsu manufactures the engine, Hydraulic Mechanical Transmission, hydraulic units, electric parts, and even each bolt on this wheel loader. Komatsu loaders are manufactured with an integrated production system under a strict quality control program.

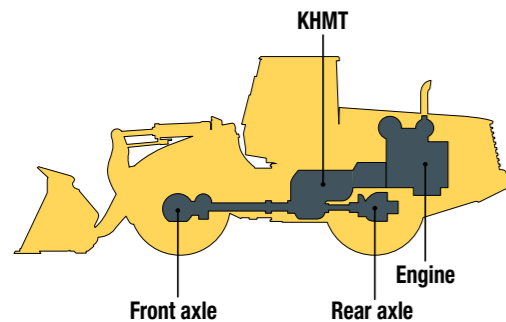

High-rigidity frames and loader linkage

The front and rear frames and the loader linkage have more torsional rigidity to provide increased resistance to stresses. The frames and loader linkage are designed to accommodate actual working loads, and simulated

computer testing proves their strength.



Wet multiple-disc brakes and fully hydraulic braking system

Wet multiple-disc brakes are fully sealed. Contaminants are kept out, reducing wear and resulting maintenance. Brakes require no adjustments for wear, meaning lower maintenance costs and higher reliability. The parking brake is also adjustment-free, with wet multiple-disc for high reliability and long life. Added reliability is designed into the braking system by the use of two independent hydraulic circuits, providing hydraulic backup should one of the circuits fail. Fully hydraulic brakes mean no air system to bleed and no condensation of water in the system that can lead to contamination, corrosion, and freezing.

Flat face-to-face O-ring seals

Flat face-to-face O-ring seals are used to securely seal hydraulic hose connections and to prevent oil leakage. In addition, buffer rings are installed to the head side of the all-hydraulic cylinders to lower the load on the rod seals and maximize the reliability.

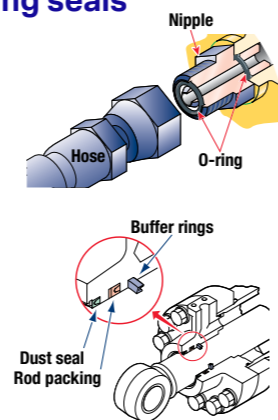

Cation electrodeposition primer paint/powder coating final paint

Cation electrodeposition paint is applied as a primer paint and powder coating is applied as topcoat to the exterior metal sheet parts. This process results in a beautiful rust resistant machine, even in the most severe environments. Some external parts are made of plastic providing long life and high impact resistance.

Sealed connectors

Main harnesses and controller connectors are equipped with sealed connectors providing high reliability, water resistance and dust resistance.

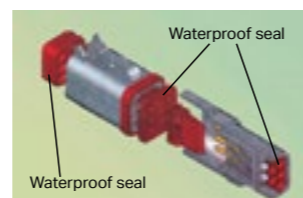

High Resolution 7-inch colour Liquid Crystal Display (LCD) monitor

The machine monitor displays various machine information and allows for various settings of the machine. The monitor is a 7-inch color LCD monitor displays maintenance information, operation record, Ecology guidance record, etc. The command selector is used to select various screens. By using the command selector, you can display various user menus on the LCD screen and adjust the machine settings.

Machine monitor

- | | |
|-----------------------------------|---------------------------------------|
| 1 LCD unit | 9 Engine coolant temperature gauge |
| 2 LED unit | 10 DEF level gauge |
| 3 Engine tachometer | 11 Transmission oil temperature gauge |
| 4 Speedometer | 12 Hydraulic oil temperature gauge |
| 5 Shift lever position display | 13 Fuel gauge |
| 6 Travel speed control dial gauge | 14 Brake oil temperature gauge |
| 7 Traction level display | 15 Air conditioner display |
| 8 Pilot lamps | 16 Ecology gauge |

Visual user menu

Pressing the menu switch on the command selector displays the user menu screen. The menus are grouped for each function, and use easy-to-understand icons which enable the machine to be operated intuitively.



Machine monitor with troubleshooting function to minimise downtime

Various meters, gauges and warning functions are centrally arranged on the machine monitor. The monitor simplifies start-up inspection and promptly warns the operator with a lamp and buzzer if any abnormalities should occur.

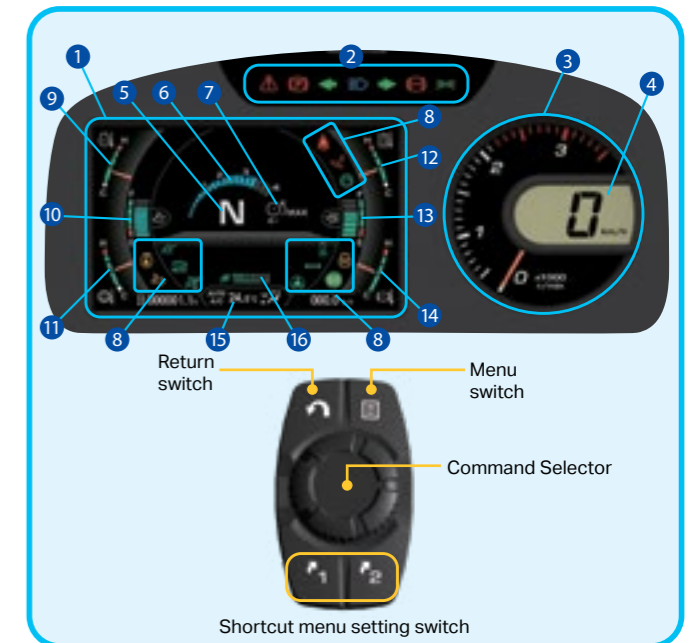

Energy saving operation ecology guidance

In order to support optimum operation, the following guidance messages are displayed for fuel saving operation.

- 1) Excessive engine idling event
- 2) Hydraulic relief pressure event
- 3) Excessive digging event



The Ecology guidance menu enables the operator to check the operation record, fuel consumption history and Ecology guidance record by pushing the button. The records can be used to reduce the overall fuel consumption.

Komtrax equipment monitoring

Get the whole story with



What

- Komtrax is Komatsu's remote equipment monitoring and management system Komtrax continuously monitors and records machine health and operational data
- Information such as fuel consumption, utilisation, and a detailed history lowering owning and operating cost

Who

- Komtrax is standard equipment on all Komatsu construction products

When

- Know when your machines are running or idling and make decisions that will improve your fleet utilisation
- Detailed movement records ensure you know when and where your equipment is moved
- Up to date records allow you to know when maintenance is due and help you plan for future maintenance needs

Where

- Komtrax data can be accessed virtually anywhere through your computer, the web or your smart phone
- Automatic alerts keep fleet managers up to date on the latest machine notifications

Why

- Knowledge is power – make informed decisions to manage your fleet better
- Knowing your idle time and fuel consumption will help maximise your machine efficiency
- Take control of your equipment – any time, anywhere.



KOMTRAX
For construction and compact equipment.

KOMTRAX Plus
For production and mining class machines.

Specifications

Engine	
Model	Komatsu SAA6D125E-7
Type	Water-cooled, 4-cycle
Aspiration	Turbo-charged, after-cooled, cooled EGR
Number of cylinders	
Bore	125 mm
Stroke	150 mm
Piston displacement	11.04 ltr
Horsepower:	
SAE J1995	Gross 217 kW 291 HP
ISO 14396	
ISO 9249 / SAE J1349	Net 216 kW 290 HP
Rated rpm	1600 min ⁻¹
Governor	All-speed, electronic
Fan drive method for radiator cooling	Hydraulic
Fuel system	Direct injection
Lubrication system:	
Method	Gear pump, force-lubrication
Filter	Full-flow type
Air cleaner	Dry type with double elements and dust evacuator, plus dust indicator
*EPA Tier 4 Final emissions certified	
Transmission	
Type	Hydraulic Mechanical planetary type
Travel speed: km/h	
Measured with 26.5R25 tyres	
Forward*	Reverse*
3.0 - 38.0	3.0 - 28.0

Axles and final drives	
Drive system	Four-wheel drive
Front	Fixed, semi-floating
Rear	Centre-pin support, semi-floating, 26° total oscillation
Reduction gear	Spiral bevel gear
Differential gear	Conventional type
Final reduction gear	Planetary gear, single reduction

Brakes	
Service brakes	Hydraulically actuated wet disc brakes, incorporating brake cooling system
Parking brake	Wet multiple-disc brake
Emergency brake	Parking brake is commonly used

Steering system	
Type	Articulated type, fully-hydraulic power steering
Steering angle	35° each direction (40° to max end stop)
Minimum turning radius at the centre of outside tyre	6630 mm

Hydraulics	
Steering system	
Hydraulic pump	Piston type
Capacity	157.7 ltr/min at rated rpm
Relief valve setting	24.5 MPa 250 kgf/cm ²
Hydraulic cylinders	
Type	Double-acting, piston type
Number of cylinders	2
Bore x stroke	91 mm x 441 mm
Loader control	
Hydraulic pump	Piston pump
Capacity	333 ltr/min at rated rpm
Relief valve setting	35.3 MPa 350 kgf/cm ²
Hydraulic cylinders:	
Type	Double-acting, piston type
Number of cylinders—bore x stroke	
Lift cylinder	2- 150 mm x 764 mm
Bucket cylinder	1- 180 mm x 540 mm
Control valve	2-spool type
Control positions:	
Boom	Raise, hold, lower, and float
Bucket	Tilt-back, hold, and dump
Hydraulic cycle time (rated load in bucket):	
Raise	5.8 s
Dump	1.8 s
Lower (Empty)	3.1 s

Service refill capacities	
Cooling system	65 ltr
Fuel tank	380 ltr
Engine	38 ltr
Hydraulic system	135 ltr
Axle front	59 ltr
Axle rear	59 ltr
Torque converter and transmission	65 ltr
DEF tank	36 ltr

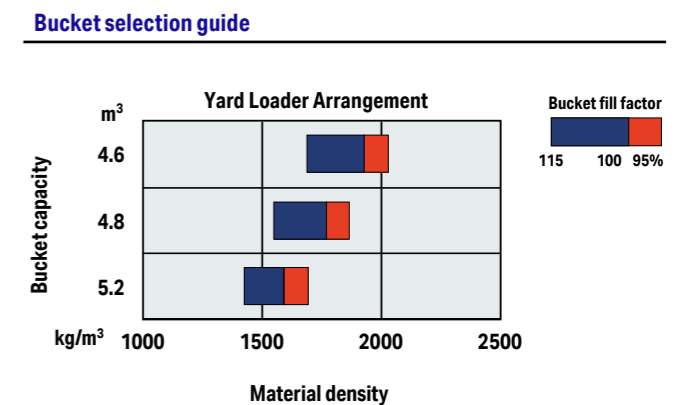

Specifications

	Standard boom	High lift boom
I Tread	2,300 mm	
J Width over tires	3,060 mm	
A Wheelbase	3,450 mm	
B Hinge pin height, max. height	4,370 mm	4870 mm
C Hinge pin height, carry position	580 mm	730 mm
D Ground clearance	520 mm	
E Hitch height	1,200 mm	
F Overall height, top of the stack	3,450 mm	
G Overall height, ROPS cab	3,500 mm	
H Overall height, top of the roof rail	3,540 mm	

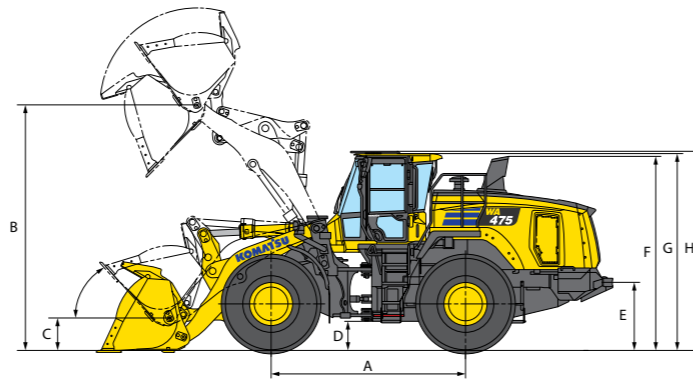

	Standard boom			
	Heavy Duty Rock Bucket	General Purpose Bucket	Loose material bucket pin on	High Lift Boom
	Bolt-on cutting edge	Bolt-on cutting edge	Bolt-on cutting edge	General Purpose Bucket
Bucket capacity: heaped	4.6 m³	4.8 m³	5.2 m³	3.8m³
Bucket capacity: struck	3.6 m³	3.8 m³	4.5 m³	3.2m²
Bucket width *with bucket side guard	3,170 mm	3,170 mm	3,190 mm	3,170 mm
Bucket weight	2,196 kg	2,290 kg	2,455mm	2,108 mm
I Dumping clearance, max. height and 45° dump angle*	3,075 mm	3,045 mm	2,925 mm	3,645 mm
J Reach at max. height and 45° dump angle*	1,350 mm	1,380 mm	1,495 mm	1,460 mm
K Reach at 2130 mm 7' clearance and 45° dump angle*	2,020 mm	2,035 mm	2,090 mm	2,510 mm
L Reach with arm horizontal and bucket level*	2,935 mm	2,975mm	3,135 mm	3,330 mm
M Operating height (fully raised)	6,090 mm	6,135 mm	6,270 mm	6,520 mm
N Overall length (bucket on ground)	9,185 mm	9,225 mm	9,395 mm	9,705 mm
Loader clearance circle (bucket at carry, outside corner of bucket)	380 mm	15,400 mm	15,500 mm	15,830 mm
Static tipping load: straight	21,150 kg	26,200 kg	20,440 kg	17,930kg
Static tipping load: 40° full turn	18,300 kg	17,985kg	17,650kg	15,520 kg
Breakout force	197.2 kN	190 kN	171 kN	206 kN
	20,110 kgf	19,430 kgf	17,450 kgf	21,049 kgf
Operating weight	26,340 kg	26,430 kg	26,660 kg	27,410 kg

* At the end of tooth or B.O.C.E. (Bolt on cutting edge)

All dimensions, weights, and performance values based on ISO 7131, ISO 14397-1 and ISO 7546 standards. Static tipping load and operating weight shown include lubricant, coolant, full fuel tank, ROPS cab, and operator. Machine stability and operating weight affected by counterweight, tyre size, and other attachments.

Standard equipment

ENGINE

- Engine, Komatsu SAA6D125E-7
- KDPF
- Alternator, 24 V/140 A
- Starting motor, 24 V/11.0 kW
- Batteries, large capacity, 2 x 12 V/140 Ah

CAB

- Seat, suspension type with reclining
- Seat mounted 5-way adjustable console R.H.
- Electronic Pilot Control fingertip control with directional selector switch, two levers
- ROPS/FOPS (ISO 3471/ISO 3449) cab
- Colour multi-monitor
- Advanced Joystick Steering System (AJSS)
- Auto air conditioner
- Multifunction Audio
- DC12V electrical outlets
- Floor mat
- Rain visor
- Rear defroster (electric)
- Front wiper (with washer and intermittent)
- Machine monitor with Equipment Management
- Monitoring System
- Rear window washer and wiper
- Seat belt, 78mm
- Huge utility space
- Cup holder

LIGHTING SYSTEM

- Rear working lamps, LED, L.H. and R.H. side, 2 lamps
- Front working lamps, LED, L.H. and R.H. side, 2 lamps
- Additional front working lamps, LED, L.H. and R.H. side, 2 lamps
- Additional rear working lamps, LED, L.H. and R.H. side, 2 lamps
- Stop and tail lamps, LED and turn signal lamps
- Headlamps, LED and R.H. side
- Directional signal
- Hazard lamps
- Back-up lights, LED

SAFETY EQUIPMENT

- Service brakes, wet disc type
- Back-up alarm
- Electric Mirror with heater
- Rearview monitoring system
- Horn, electric
- Parking brake, electric
- Anchorage points
- Handrails for platform
- Handrails for roof
- Step for cleaning window

TYRES

- 26.5R25(L-4)

OTHER

- Engine shutdown secondary switch
 - Radiator, wide core
 - Radiator mask, swing out
 - Komatsu Hydraulic Mechanical Transmission (KHMT)
 - Loader linkage with standard boom
 - 2-spool valve for boom and bucket controls
 - Counterweight, standard
 - Additional counterweight
 - Lift cylinders and bucket cylinder
 - Electronically Controlled Suspension System
 - Remote bucket positioner, in-cab adjustable, 3 positions
 - Remote boom positioner, in-cab adjustable
 - Komatsu Auto Idle Shutdown
 - Auto Shift Control
 - Jump start recepticle - Anderson
 - Lockable battery and starter isolators
 - Hydraulic-driven fan with automatic reverse rotation
 - Vandalism protection
 - Front and rear fenders
 - Brake cooling system
- KOMTRAX
- ECO guidance
 - Fuel pre-filter with water separator

Optional equipment

- 3-spool valve with lever and piping
- Steering wheel, tiltable, telescopic
- Engine pre-cleaner with extension
- Front fenders with extensions
- Headlamps, LED, L.H. and R.H. side
- High-lift boom

- Limited slip differential (F&R)
- Multifunction mono-lever loader control with transmission F-N-R switch
- Various bucket options
- Various tire options

Product designs, specifications and/or data in this document are provided for informational purposes only and are not warranties of any kind. Product designs and/or specifications may be changed at any time without notice. The only warranties that apply to sales of products and services are Komatsu's standard written warranties, which will be furnished upon request.

Komatsu and other trademarks and service marks used herein are the property of Komatsu Ltd., Komatsu Australia Pty Ltd., Komatsu New Zealand Limited, Komatsu America Corp., Komatsu Mining Corp., or one of their affiliates, or the respective owners or licensees.

KOMATSU

[komatsu.com.au](https://www.komatsu.com.au)

