

Bertrand Puma Hydraulic Divider

Description

All steel body with optional controls to automatically lift the blades, without the need for blocks. Eliminating damage to the blades. Will divide weights up to 900gm.

Stainless steel cutting blades with over sized hydraulic pump. Side flour duster and multi-division frame for 40 pieces available. These machines are fitted with a patented flour anti-spattering system.

The D20C or DC20R are hydraulic dividers with a Square (20C) or Round (20R) tanks, able to divide the dough into 20 dough pieces. The use of a divider allows the division of the dough in equal weight dough balls. This device replaces the manual division, bringing a saving of time and a greater precision.

The front of the new Divitrad is fitted with a button to adjust pressure on the dough according to a scale of 1 to 6. Position n° 1 is used to pack down very gently, reducing gas release from the dough to a minimum. It is therefore possible to save time by shortening expansion and moulding times while obtaining a high quality product and unique taste.



Round or Square Tanks

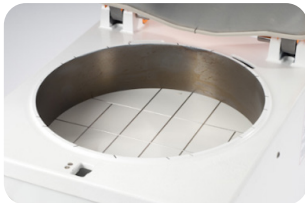

Bertrand Puma Hydraulic Divider Specifications

■ Dimensions



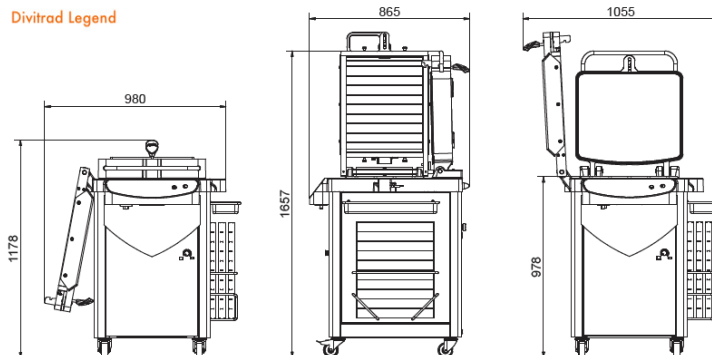





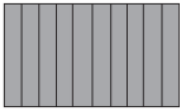

Divitrad Legend

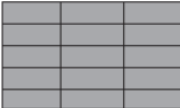











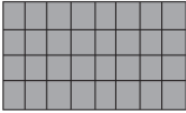
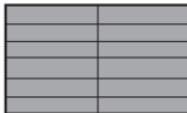
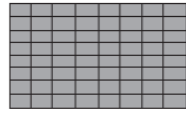
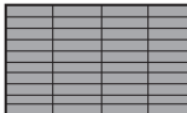
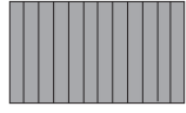
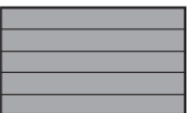

Divitrad Legend

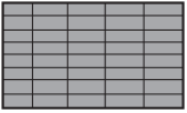
Bertrand Puma Hydraulic Divider

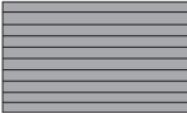
Model	D20C	D20R	D24	Divitrad Legend
Dough Capacity (Kg)	18	18	15	18
Divisions	20	20	24	20
Dimensions WxDxH mm	600 x 820 x 1160	600 x 820 x 1160	560 x 750 x 1050	1055 x 865 x 1178
Height - Lid Open	1800	1800	1610	1657
Weight (Kg)	240	240	240	300
Power (Kw)	1.5	1.5	1.5	1.5
Voltage	415V 3 phase 10 Amp			

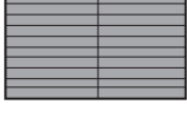
	DIVITRAD		DIVITRAD
Grille N°1 - 10 divisions (400x50) TradiCut		Grille N°25 - 6 divisions horizontales (514x66)	
Grille N°2 - 2x10 divisions (200x50) TradiCut		Grille N°26 - 6 divisions verticales (411x83)	
Grille N°3 - 4x10 divisions (100x50)		Grille N°27 - 8 divisions horizontales (514x50)	
Grille N°4 - 8x10 divisions (50x50)		Grille N°28 - 7 divisions verticales (411x71)	
Grille N°5 - 8 divisions verticales (400x60) TradiCut		Grille N°29 - 8+4 divisions (260x63)	
Grille N°6 - 2x8 divisions (200x60) TradiCut		Grille N°30 - 5x2 divisions (255x80)	

Bertrand Puma Hydraulic Divider

	DIVITRAD		DIVITRAD
Grille N°7 - 4x8 divisions (100x60)		Grille N°31 - 6x2 divisions (255x66)	
Grille N°8 - 8x8 divisions (50x60)		Grille N°32 - 10x4 divisions (125x40)	
Grille N°9 - 12 divisions verticales (400x40)		Grille N°33 - 5 divisions horizontales (514x80)	
Grille N°10 - 3x4 divisions (140x130)		Grille N°34 - 2x4 divisions (125x204)	
Grille N°11 - 6x8 divisions (70x65)		Grille N°35 - 8x5 divisions (100x49)	
Grille N°12 - 13 divisions verticales (400x40)		Grille N°36 - 10 divisions horizontales (514,5x38,5)	
Grille N°13 - 2x12 divisions (204x40)		Grille N°37 - 10x2 divisions (255x38,5)	
Grille N°14 - 10+2 divisions (50x345 - 250x63)		Grille N°38 - 5x6 divisions (83x80)	
Grille N°15 - 5 divisions verticales (410x100)		Grille N°39 - 4x2 divisions (255x100)	

Bertrand Puma Hydraulic Divider

	DIVITRAD		DIVITRAD
Grille N°16 - 2x3 divisions (204x170)		Grille N°40 - 2x9 divisions (54x204)	
Grille N°17 - 3x3 divisions (135x170)		Grille N°41 - 5x4 divisions (125x80)	
Grille N°18 - 2x5 divisions (100x200)		Grille N°42 - 2 divisions (255x411)	
Grille N°19 - 2x6 divisions (200x80)		Grille N°43 - 2 divisions (515x205)	
Grille N°20 - 8x2 divisions (255x50)		Grille N°44 - 160 divisions (255x411)	
Grille N°21 - 7x2 divisions (255x56)		Grille N°45 - 12x6 divisions (83x31,5)	
Grille N°22 - 4x5 divisions (100x100)		Grille N°46 - 10x10 divisions = 100D (48x38)	
Grille N°23 - 3x8 divisions (61x135)		Grille N°47 - 3x10 divisions = 30D (48x135)	
Grille N°24 - 5x3 divisions (169x80)		Grille N°48 - 4x4 divisions = 16D (125x100)	