



# Handheld Thermal Camera

G Series User Manual

## Legal Information

©2022 Hangzhou Microimage Software Co., Ltd. All rights reserved.

### About this Manual

The Manual includes instructions for using and managing the Product. Pictures, charts, images and all other information hereinafter are for description and explanation only. The information contained in the Manual is subject to change, without notice, due to firmware updates or other reasons. Please find the latest version of this Manual at the HIKMICRO website (<http://www.hikmicrotech.com>).

Please use this Manual with the guidance and assistance of professionals trained in supporting the Product.

### Trademarks

 **HIKMICRO** and other HIKMICRO's trademarks and logos are the properties of HIKMICRO in various jurisdictions.

 **HDMI**<sup>™</sup>: The terms HDMI and HDMI High-Definition Multimedia Interface, and the HDMI Logo are trademarks or registered trademarks of HDMI Licensing Administrator, Inc. in the United States and other countries.

Other trademarks and logos mentioned are the properties of their respective owners.

### Disclaimer

TO THE MAXIMUM EXTENT PERMITTED BY APPLICABLE LAW, THIS MANUAL AND THE PRODUCT DESCRIBED, WITH ITS HARDWARE, SOFTWARE AND FIRMWARE, ARE PROVIDED "AS IS" AND "WITH ALL FAULTS AND ERRORS". HIKMICRO MAKES NO WARRANTIES, EXPRESS OR IMPLIED, INCLUDING WITHOUT LIMITATION, MERCHANTABILITY, SATISFACTORY QUALITY, OR FITNESS FOR A PARTICULAR PURPOSE. THE USE OF THE PRODUCT BY YOU IS AT YOUR OWN RISK. IN NO EVENT WILL HIKMICRO BE LIABLE TO YOU FOR ANY SPECIAL, CONSEQUENTIAL, INCIDENTAL, OR INDIRECT DAMAGES, INCLUDING, AMONG OTHERS, DAMAGES FOR LOSS OF BUSINESS PROFITS, BUSINESS INTERRUPTION, OR LOSS OF DATA, CORRUPTION OF SYSTEMS, OR LOSS OF DOCUMENTATION, WHETHER BASED ON BREACH OF CONTRACT, TORT (INCLUDING NEGLIGENCE), PRODUCT LIABILITY, OR OTHERWISE, IN CONNECTION WITH THE USE OF THE PRODUCT, EVEN IF HIKMICRO HAS BEEN ADVISED OF THE POSSIBILITY OF SUCH DAMAGES OR LOSS.

YOU ACKNOWLEDGE THAT THE NATURE OF THE INTERNET PROVIDES FOR INHERENT SECURITY RISKS, AND HIKMICRO SHALL NOT TAKE ANY RESPONSIBILITIES FOR ABNORMAL OPERATION, PRIVACY LEAKAGE OR OTHER DAMAGES RESULTING FROM CYBER-ATTACK, HACKER ATTACK, VIRUS INFECTION, OR OTHER INTERNET SECURITY RISKS; HOWEVER, HIKMICRO WILL PROVIDE TIMELY TECHNICAL SUPPORT IF REQUIRED.

YOU AGREE TO USE THIS PRODUCT IN COMPLIANCE WITH ALL APPLICABLE LAWS, AND YOU ARE SOLELY RESPONSIBLE FOR ENSURING THAT YOUR USE CONFORMS TO THE APPLICABLE LAW. ESPECIALLY, YOU ARE RESPONSIBLE, FOR USING THIS PRODUCT IN A MANNER THAT DOES NOT

## Handheld Thermal Camera G Series User Manual

---

INFRINGE ON THE RIGHTS OF THIRD PARTIES, INCLUDING WITHOUT LIMITATION, RIGHTS OF PUBLICITY, INTELLECTUAL PROPERTY RIGHTS, OR DATA PROTECTION AND OTHER PRIVACY RIGHTS. YOU SHALL NOT USE THIS PRODUCT FOR ANY PROHIBITED END-USES, INCLUDING THE DEVELOPMENT OR PRODUCTION OF WEAPONS OF MASS DESTRUCTION, THE DEVELOPMENT OR PRODUCTION OF CHEMICAL OR BIOLOGICAL WEAPONS, ANY ACTIVITIES IN THE CONTEXT RELATED TO ANY NUCLEAR EXPLOSIVE OR UNSAFE NUCLEAR FUEL-CYCLE, OR IN SUPPORT OF HUMAN RIGHTS ABUSES.

IN THE EVENT OF ANY CONFLICTS BETWEEN THIS MANUAL AND THE APPLICABLE LAW, THE LATTER PREVAILS.

## Regulatory Information

---

### Note

These clauses apply only to the products bearing the corresponding mark or information.

---

### FCC Compliance Statement

Please take attention that changes or modification not expressly approved by the party responsible for compliance could void the user's authority to operate the equipment. This device complies with Part 15 of the FCC Rules. Operation is subject to the following two conditions:

- (1) This device may not cause harmful interference, and
- (2) This device must accept any interference received, including interference that may cause undesired operation.

Note: Due to the device size limit, the above statement may not be disclaimed on the device. This equipment complies with FCC radiation exposure limits set forth for an uncontrolled environment.

Note: This product has been tested and found to comply with the limits for a Class B digital device, pursuant to Part 15 of the FCC Rules. These limits are designed to provide reasonable protection against harmful interference in a residential installation. This product generates, uses, and can radiate radio frequency energy and, if not installed and used in accordance with the instructions, may cause harmful interference to radio communications. However, there is no guarantee that interference will not occur in a particular installation. If this product does cause harmful interference to radio or television reception, which can be determined by turning the equipment off and on, the user is encouraged to try to correct the interference by one or more of the following measures:

- Reorient or relocate the receiving antenna.
- Increase the separation between the equipment and receiver.
- Connect the equipment into an outlet on a circuit different from that to which the receiver is connected.
- Consult the dealer or an experienced radio/TV technician for help.

### EU/UKCA Conformity Statement



This product and - if applicable - the supplied accessories too are marked with "CE" and comply therefore with the applicable harmonized European standards listed under the EMC Directive 2014/30/EU, RE Directive 2014/53/EU, the RoHS Directive 2011/65/EU



This product and - if applicable - the supplied accessories too are marked with "UKCA" and comply therefore with the following directives: Radio Equipment Regulations 2017, Electromagnetic Compatibility Regulations 2016, Electrical Equipment (Safety) Regulations 2016, the Restriction of the Use of Certain Hazardous Substances in Electrical and Electronic Equipment Regulations 2012.

## Frequency Bands and Power (for CE/UKCA)

The frequency bands and transmitting power (radiated and/or conducted) nominal limits applicable to the following radio equipment are as follows:

Equipment Model	Frequency Band and Power
G31, G41, G61*	Wi-Fi 2.4 GHz (2.4 GHz to 2.4835 GHz): 20 dBm; Bluetooth 2.4 GHz (2.4 GHz to 2.4835 GHz): 20 dBm  Wi-Fi 5 GHz (5.15 GHz to 5.25 GHz): 23 dBm; Wi-Fi 5 GHz (5.25 GHz to 5.35 GHz): 23 dBm; Wi-Fi 5 GHz (5.47 GHz to 5.725GHz): 23 dBm; Wi-Fi 5 GHz (5.725 GHz to 5.85 GHz): 14 dBm
G40, G60	Wi-Fi 2.4 GHz (2.4 GHz to 2.4835 GHz): 20 dBm; Bluetooth 2.4 GHz (2.4 GHz to 2.4835 GHz): 20 dBm

\*For G31, G41, G61, please pay attention to the following notes when the device is operating in 5 GHz:

According to Article 10 (10) of Directive 2014/53/EU, when operating in the 5150 to 5350 MHz frequency range, this device is restricted to indoor use in: Austria (AT), Belgium (BE), Bulgaria (BG), Croatia (HR), Cyprus (CY), the Czech Republic (CZ), Denmark (DK), Estonia (EE), Finland (FI), France (FR), Germany (DE), Greece (EL), Hungary (HU), Iceland (IS), Ireland (IE), Italy (IT), Latvia (LV), Liechtenstein (LI), Lithuania (LT), Luxembourg (LU), Malta (MT), Netherlands (NL), Northern Ireland (UK(NI)), Norway (NO), Poland (PL), Portugal (PT), Romania (RO), Slovakia (SK), Slovenia (SI), Spain (ES), Sweden (SE), Switzerland (CH), and Turkey (TR).

In accordance with the Radio Equipment Regulations 2017 in the UK, the device working in the 5150 to 5350 MHz frequency range is restricted to indoor use in the United Kingdom.

Use the power adapter provided by a qualified manufacturer. Refer to the product specification for detailed power requirements.

Use the battery provided by a qualified manufacturer. Refer to the product specification for detailed battery requirements.



2012/19/EU (WEEE directive): Products marked with this symbol cannot be disposed of as unsorted municipal waste in the European Union. For proper recycling, return this product to your local supplier upon the purchase of equivalent new equipment, or dispose of it at designated collection points. For more information see: [www.recyclethis.info](http://www.recyclethis.info)

According to the Waste Electrical and Electronic Equipment Regulations 2013: Products marked with this symbol cannot be disposed of as unsorted municipal waste in the United Kingdom. For proper recycling, return this product to your local supplier upon the purchase of equivalent new equipment, or dispose of it at designated collection points. For more information see: [www.recyclethis.info](http://www.recyclethis.info).

2006/66/EC (battery directive): This product contains a battery that cannot be disposed of as unsorted municipal waste in the European Union. See the product documentation for specific battery information. The battery is marked with this symbol, which may include lettering to indicate cadmium (Cd), lead (Pb), or mercury (Hg). For proper recycling, return the battery to your supplier or to a designated collection point. For more information see: [www.recyclethis.info](http://www.recyclethis.info)



According to the Batteries and Accumulators (Placing on the Market) Regulations 2008 and the Waste Batteries and Accumulators Regulations 2009: This product contains a battery that cannot be disposed of as unsorted municipal waste in the United Kingdom. See the product documentation for specific battery information. The battery is marked with this symbol, which may include lettering to indicate cadmium (Cd), lead (Pb), or mercury (Hg). For proper recycling, return the battery to your supplier or to a designated collection point. For more information see: [www.recyclethis.info](http://www.recyclethis.info).

### Industry Canada ICES-003 Compliance

This device meets the CAN ICES-003(B)/NMB-003(B) standards requirements.

This device complies with Industry Canada licence-exempt RSS standard(s). Operation is subject to the following two conditions:

- (1) this device may not cause interference, and
- (2) this device must accept any interference, including interference that may cause undesired operation of the device.

This equipment complies with IC RSS-102 radiation exposure limits set forth for an uncontrolled environment.

\*For G31, G41, G61, please pay attention to the following notes when the device is operating in 5 GHz:

- (i) The device for operation in the band 5150-5250 MHz is only for indoor use to reduce the potential for harmful interference to co-channel mobile satellite systems;
- (ii) The maximum antenna gain permitted for devices in the bands 5250-5350 MHz and 5470-5725 MHz shall comply with the e.i.r.p. limit; and
- (iii) The maximum antenna gain permitted for

Le présent appareil est conforme aux CNR d'Industrie Canada applicables aux appareils radioexempts de licence. L'exploitation est autorisée aux deux conditions suivantes :

- (1) l'appareil ne doit pas produire de brouillage, et
- (2) l'utilisateur de l'appareil doit accepter tout brouillage radioélectrique subi, même si le brouillage est susceptible d'en compromettre le fonctionnement.

ce matériel est conforme aux limites de dose d'exposition aux rayonnements, CNR-102 énoncée dans un autre environnement.

- (i) Les dispositifs fonctionnant dans la bande 5150-5250 MHz sont réservés uniquement pour une utilisation à l'intérieur afin de réduire les risques de brouillage préjudiciable aux systèmes de satellites mobiles utilisant les mêmes canaux.
- (ii) Le gain d'antenne maximal autorisé pour les appareils dans les bandes 5250-5350 MHz et 5470-5725 MHz doivent respecter le pire

devices in the band 5725-5825 MHz shall comply with the e.i.r.p. limits specified for point-to-point and non point-to-point operation as appropriate.

limiter; et



(iii) Le gain d'antenne maximal autorisé pour les appareils dans la bande 5725-5825 MHz doivent respecter le pire limites spécifiées pour le point-à-point et l'exploitation non point à point, le cas échéant.

## KC

B급 기기: 이 기기는 가정용(B급) 전자파적합기기로서 주로 가정에서 사용하는 것을 목적으로 하며, 모든 지역에서 사용할 수 있습니다.

## Symbol Conventions

The symbols that may be found in this document are defined as follows.

Symbol	Description
 <b>Danger</b>	Indicates a hazardous situation which, if not avoided, will or could result in death or serious injury.
 <b>Caution</b>	Indicates a potentially hazardous situation which, if not avoided, could result in equipment damage, data loss, performance degradation, or unexpected results.
 <b>Note</b>	Provides additional information to emphasize or supplement important points of the main text.



## Safety Instruction

These instructions are intended to ensure that user can use the product correctly to avoid danger or property loss.

### Laws and Regulations

- Use of the product must be in strict compliance with the local electrical safety regulations.

### Transportation

- Keep the device in original or similar packaging while transporting it.
- Keep all wrappers after unpacking them for future use. In case of any failure occurred, you need to return the device to the factory with the original wrapper. Transportation without the original wrapper may result in damage on the device and the company shall not take any responsibilities.
- DO NOT drop the product or subject it to physical shock. Keep the device away from magnetic interference.

### Power Supply

- Input voltage for device should meet the Limited Power Source (5 VDC, 940 mA) according to the IEC61010-1 standard. Please refer to technical specifications for detailed information.
- Make sure the plug is properly connected to the power socket.
- DO NOT connect multiple devices to one power adapter, to avoid over-heating or fire hazards caused by overload.

### Battery

- Improper use or replacement of the battery may result in explosion hazard. Replace with the same or equivalent type only. Dispose of used batteries in conformance with the instructions provided by the battery manufacturer.
- The built-in battery cannot be dismantled. Please contact the manufacture for repair if necessary.
- For long-term storage of the battery, make sure it is fully charged every half year to ensure the battery quality. Otherwise, damage may occur.
- DO NOT charge other battery types with the supplied charger. Confirm there is no flammable material within 2 m of the charger during charging.
- DO NOT place the battery near heating or fire source. Avoid direct sunlight.
- DO NOT swallow the battery to avoid chemical burns.
- DO NOT place the battery in the reach of children.
- When the device is powered off and the RTC battery is full, the time settings can be kept for 15 days.
- In the first use, power on the device and charge the RTC battery with the lithium battery for more than 10 hours.
- The lithium battery voltage is 3.6 V, and the battery capacity is 6700 mAh.
- The battery is certified by UL2054.

## Maintenance

- If the product does not work properly, please contact your dealer or the nearest service center. We shall not assume any responsibility for problems caused by unauthorized repair or maintenance.
- A few device components (e.g., electrolytic capacitor) require regular replacement. The average lifespan varies, so periodic checking is recommended. Contact your dealer for details.
- Wipe the device gently with a clean cloth and a small quantity of ethanol, if necessary.
- If the equipment is used in a manner not specified by the manufacturer, the protection provided by the device may be impaired.
- We recommend you send the device back for calibration once a year, and please contact the local dealer for the information on maintenance points.
- Please notice that the current limit of USB 3.0 PowerShare port may vary with the PC brand, which is likely to result in incompatibility issue. Therefore it's advised to use regular USB 3.0 or USB 2.0 port if the USB device fails to be recognized by PC via USB 3.0 PowerShare port.

## Using Environment

- Make sure the running environment meets the requirement of the device. The operating temperature shall be -10°C to 50°C (14°F to 122°F), and the operating humidity shall be 90% or less.
- DO NOT expose the device to high electromagnetic radiation or dusty environments.
- DO NOT aim the lens at the sun or any other bright light.

## Technical Support

The <https://www.hikmicrotech.com> portal will help you as a HIKMICRO customer to get the most out of your HIKMICRO products. The portal gives you access to our support team, software and documentation, service contacts, etc.

## Emergency

- If smoke, odor, or noise arises from the device, immediately turn off the power, unplug the power cable, and contact the service center.

## Laser Light Supplement Warning



Warning: The laser radiation emitted from the device can cause eye injuries, burning of skin or inflammable substances. Prevent eyes from direct laser. Before enabling the Light Supplement function, make sure no human or inflammable substances are in front of the laser lens. The wave length is 650 nm, and the power is less than 1 mW. The laser meets the IEC60825-1:2014 standard.

Laser maintenance: It is not necessary to maintain the laser regularly. If the laser does not work, the laser assembly needs to be replaced in the factory under warranty. Keep the device power off when replacing laser assembly. Caution-Use of controls or adjustments or performance of

procedures other than those specified herein may result in hazardous radiation exposure.

### **Manufacture Address**

Room 313, Unit B, Building 2, 399 Danfeng Road, Xixing Subdistrict, Binjiang District, Hangzhou, Zhejiang 310052, China

Hangzhou Microimage Software Co., Ltd

COMPLIANCE NOTICE: The thermal series products might be subject to export controls in various countries or regions, including without limitation, the United States, European Union, United Kingdom and/or other member countries of the Wassenaar Arrangement. Please consult your professional legal or compliance expert or local government authorities for any necessary export license requirements if you intend to transfer, export, re-export the thermal series products between different countries.

# Contents

<b>Chapter 1 Overview</b> .....	<b>1</b>
<b>1.1 Device Description</b> .....	<b>1</b>
<b>1.2 Main Function</b> .....	<b>1</b>
<b>1.3 Appearance</b> .....	<b>2</b>
<b>Chapter 2 Preparation</b> .....	<b>5</b>
<b>2.1 Charge Device</b> .....	<b>5</b>
<b>2.1.1 Charge Device via Cable Interface</b> .....	<b>5</b>
<b>2.1.2 Charge Device via Charging Base</b> .....	<b>5</b>
<b>2.2 Mount Hand Strap</b> .....	<b>6</b>
<b>2.3 Mount Protective Cover</b> .....	<b>8</b>
<b>2.4 (Optional) Mount Interchangeable Lens</b> .....	<b>8</b>
<b>2.4.1 Calibrate Interchangeable Lens</b> .....	<b>10</b>
<b>2.5 Power On/Off</b> .....	<b>12</b>
<b>2.5.1 Set Auto Power-off Duration</b> .....	<b>12</b>
<b>2.6 Operation Method</b> .....	<b>13</b>
<b>2.7 Menu Description</b> .....	<b>13</b>
<b>Chapter 3 Display Settings</b> .....	<b>16</b>
<b>3.1 Focus</b> .....	<b>16</b>
<b>3.1.1 Focus Lens</b> .....	<b>16</b>
<b>3.1.2 Laser Assisted Focus</b> .....	<b>17</b>
<b>3.1.3 Auto Focus</b> .....	<b>17</b>
<b>3.1.4 Continuous Autofocus</b> .....	<b>17</b>
<b>3.2 Set Screen Brightness</b> .....	<b>18</b>
<b>3.3 Set Display Mode</b> .....	<b>18</b>
<b>3.4 Set Palettes</b> .....	<b>19</b>
<b>3.4.1 Set Alarm Mode Palettes</b> .....	<b>20</b>
<b>3.4.2 Set Focus Mode Palettes</b> .....	<b>20</b>
<b>3.5 Adjust Digital Zoom</b> .....	<b>21</b>
<b>3.6 Display OSD Info</b> .....	<b>21</b>

<b>Chapter 4 Temperature Measurement.....</b>	<b>23</b>
<b>4.1 Set Thermography Parameters .....</b>	<b>23</b>
4.1.1 Set Unit .....	24
<b>4.2 Adjust Display Temperature Range .....</b>	<b>24</b>
<b>4.3 Set Temperature Measurement Rule .....</b>	<b>25</b>
4.3.1 Set Point Rule .....	25
4.3.2 Set Line Rule .....	26
4.3.3 Set Area Rule .....	27
4.3.4 Delete Rules.....	27
<b>4.4 Calculate Area Size .....</b>	<b>27</b>
<b>4.5 Temperature Alarm .....</b>	<b>28</b>
4.5.1 Set Alarms for Exceptional Temperatures.....	28
<b>Chapter 5 Route Inspection .....</b>	<b>29</b>
<b>5.1 Create Inspection Route and Send Task to Device.....</b>	<b>29</b>
<b>5.2 Perform Route Inspection .....</b>	<b>30</b>
<b>5.3 Upload Inspection Result and View Report .....</b>	<b>31</b>
<b>Chapter 6 Picture and Video .....</b>	<b>34</b>
<b>6.1 Capture Picture.....</b>	<b>34</b>
<b>6.2 Scan QR Code.....</b>	<b>35</b>
<b>6.3 Record Video .....</b>	<b>35</b>
<b>6.4 View Local Files.....</b>	<b>36</b>
<b>6.5 Export Files .....</b>	<b>37</b>
<b>Chapter 7 Distance Detection .....</b>	<b>39</b>
<b>Chapter 8 Geographic Location Display.....</b>	<b>40</b>
<b>Chapter 9 Direction Display .....</b>	<b>41</b>
<b>9.1 Calibrate Compass.....</b>	<b>41</b>
<b>9.2 Magnetic Declination Correction.....</b>	<b>42</b>

<b>Chapter 10 Connect Bluetooth.....</b>	<b>43</b>
<b>Chapter 11 Set LED Light.....</b>	<b>44</b>
<b>Chapter 12 Cast Device Screen to PC.....</b>	<b>45</b>
<b>Chapter 13 Connect Device to Wi-Fi.....</b>	<b>46</b>
<b>Chapter 14 Set Device Hotspot .....</b>	<b>47</b>
<b>Chapter 15 Thermal View Mobile Client Connection .....</b>	<b>48</b>
<b>15.1 Connect via Wi-Fi.....</b>	<b>48</b>
<b>15.2 Connect via Hot Spot.....</b>	<b>48</b>
<b>Chapter 16 Image Local Output .....</b>	<b>49</b>
<b>Chapter 17 Maintenance .....</b>	<b>50</b>
<b>17.1 View Device Information .....</b>	<b>50</b>
<b>17.2 Set Date and Time .....</b>	<b>50</b>
<b>17.3 Upgrade Device .....</b>	<b>50</b>
<b>17.4 Restore Device.....</b>	<b>50</b>
<b>17.5 Initialize Memory Card.....</b>	<b>51</b>
<b>17.6 About Calibration .....</b>	<b>51</b>
<b>Chapter 18 Appendix.....</b>	<b>52</b>
<b>18.1 Common Material Emissivity Reference .....</b>	<b>52</b>
<b>18.2 FAQ.....</b>	<b>52</b>
<b>18.3 Device Command.....</b>	<b>53</b>
<b>18.4 Device Communication Matrix .....</b>	<b>53</b>

# Chapter 1 Overview

## 1.1 Device Description

The handheld thermography camera is a device with both optical images and thermal images. It can do thermography, distance measurement, video recording, snapshot capturing, alarm, and it can connect to Wi-Fi, hotspot and Bluetooth. The built-in high-sensitivity IR detector and high-performance sensor detects the variation of temperature and measure the real-time temperature. The temperature measurement range is -20 °C to 650 °C (-4 °F to 1202 °F) with the max. accuracy of  $\pm 2$  °C ( $\pm 3.6$  °F) or 2%. The built-in laser module detects the target distance. The device is easy to use, and adopts ergonomic design. It is widely applied to substations, electricity prevention detection of companies, and reconnaissance survey of construction field.

## 1.2 Main Function

### Thermography

Device detects the real-time temperature, and display it on the screen.

### Distance Measurement

Device can detect the target distance with the laser light.

### Fusion

Device can display fusion of thermal view and optical view.

### Route Inspection

Device can check the temperature of the check points in a predefined inspection route, and upload the results to center client for analysis.

### Geographical Location and Direction Display

For some models that are equipped satellite positioning module and compass, geographical location and direction display are supported.

---

#### Note

The function is supported by certain models of this series.

---

### HDMI Output

For some models that have a micro HDMI output interface, you can connect the device to a display unit to view live image.

## Note

The function is supported by certain models of this series.

## Palette and Alarm

Device supports multiple palettes, and you can set the palette mode according to the alarm function.

## Client Software Connection

- Mobile Phone: Use HIKMICRO Viewer to view live image, capture snapshots, and record videos on your phone. You can also, analyze pictures offline, generate and share a report via the app. Scan the QR codes on the cover to download the App.
- PC: Use HIKMICRO Analyzer to analyze pictures offline professionally, and generate a custom format report on your PC. Download the client software from <https://www.hikmicrotech.com/en/product-c-detail/18>  
PC: Use HIKMICRO Inspector to create inspection routes, send route inspection task to devices, collect inspection results and generate analysis reports.

## Bluetooth

Device can be connected to headset via Bluetooth, and you can hear the voice in the recording or capture.

## 1.3 Appearance

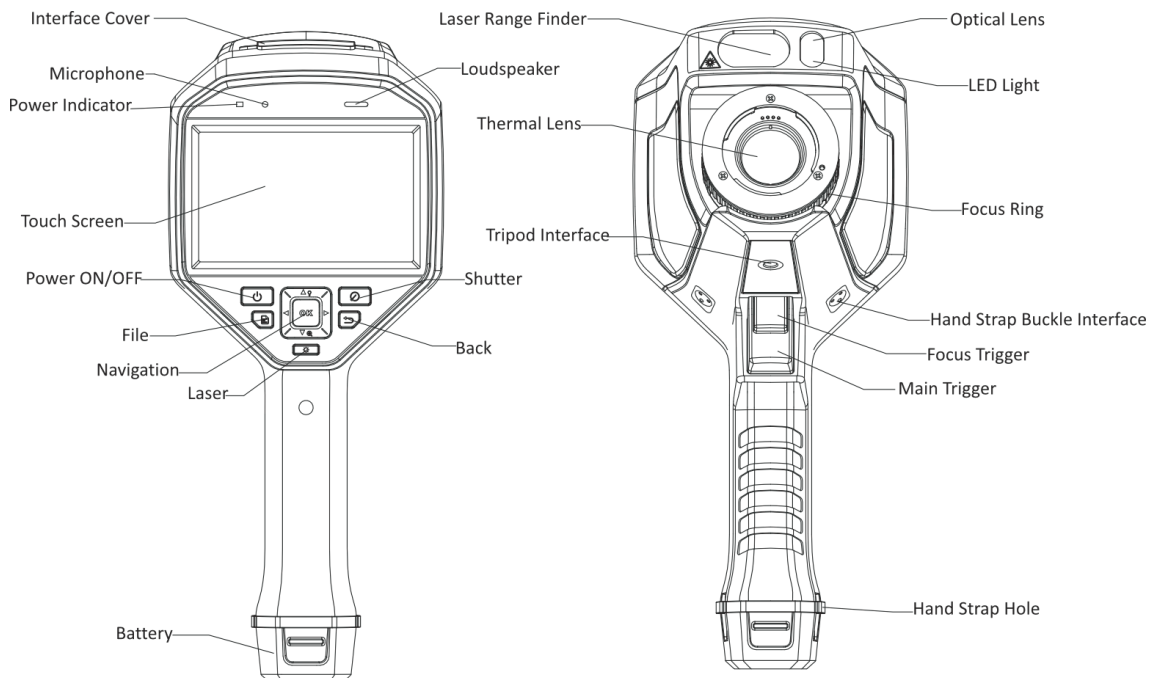
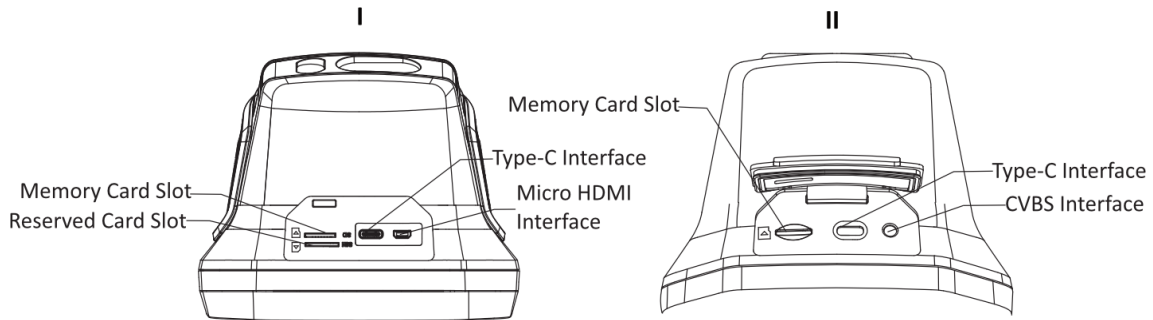

Figure 1-1 Appearance



# Handheld Thermal Camera G Series User Manual



## Note

- The interface of the device may vary according to different models. Please refer to the actual product.
- The warning sign is under the laser and on the left of the device.

**Table 1-1 Interface Description**

Component	Function
Laser Button	Hold the button to turn on laser, and release the button to turn off laser.
Navigation Button	Menu Mode: <ul style="list-style-type: none"> <li>• Press <math>\Delta</math>, <math>\nabla</math>, <math>\triangleright</math>, and <math>\triangleleft</math> to select parameters.</li> <li>• Press <math>\triangleright</math> to enter the submenu.</li> <li>• Press <math>\triangleleft</math> to return to the previous menu.</li> <li>• Press <math>\text{OK}</math> to confirm.</li> </ul>
	Non-Menu Mode: <ul style="list-style-type: none"> <li>• Press <math>\Delta</math> to turn on/off the LED light.</li> <li>• Press <math>\nabla</math> to start digital zoom.</li> </ul>
Shutter Button	Press the button to perform image correction with a shutter click in the camera.
Back Button	Exit the menu or return to previous menu.
Focus Ring	Adjust the lens position at the optical axis of the thermal lens. Refer to <b><u>Focus Lens</u></b> .
Main Trigger	Pull the trigger to capture or scan the QR code. Hold the trigger to record videos.
Focus Trigger	Pull the trigger to enable laser assisted focus/auto focus function.

 **Caution**

The laser radiation emitted from the device can cause eye injuries, burning of skin or inflammable substances. Before enabling the light supplement function, make sure no human or inflammable substances are in front of the laser lens.

## Chapter 2 Preparation

### 2.1 Charge Device

---

#### Caution

The built-in cell battery that powers the real time clock (RTC) of the device may drain during longtime transportation or storage. It is recommended to recharge the RTC battery for the well-functioning of the device clock.

To fully charge the RTC battery, the following requirements should be met:

- The rechargeable lithium batteries should be installed on the device.
  - The device should keep working for more than 10 hours before shutting down.
- 

#### 2.1.1 Charge Device via Cable Interface

##### Before You Start

Please make sure the battery is installed before charging.

##### Steps

1. Open the top cover of the device.
2. Connect the interface and the power adaptor with Type-C or USB cable.

#### 2.1.2 Charge Device via Charging Base

##### Steps

---

#### Note

Please charge the device with the cable and power adapter supplied by the manufacturer (or according to the input voltage from the specifications).

---

1. Hold the device, and press both battery lock catches of the device.

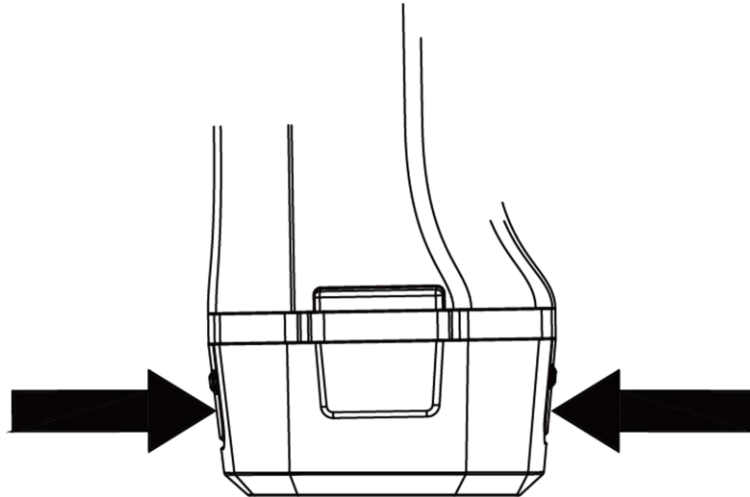

**Figure 2-1 Remove Battery Base**

2. Hold the lock catches, and draw the battery base to take out the battery.
3. Insert the battery into the charging base. You can see the charging status via the pilot lamp on the charging base.

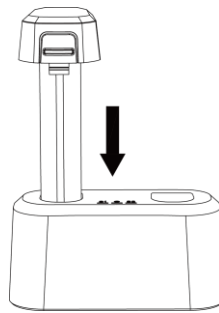

**Figure 2-2 Charge Battery**

4. When the battery is fully charged, draw the battery from the charging base.
5. Insert battery into the device.

## 2.2 Mount Hand Strap

The upper part of the hand strap is attached to the camera by a buckle. There are two buckles on both sides of the camera. The lower part of the hand strap is threaded through the hole at the base of the camera.

### Steps

1. Insert the upper part of the hand strap into the buckle.

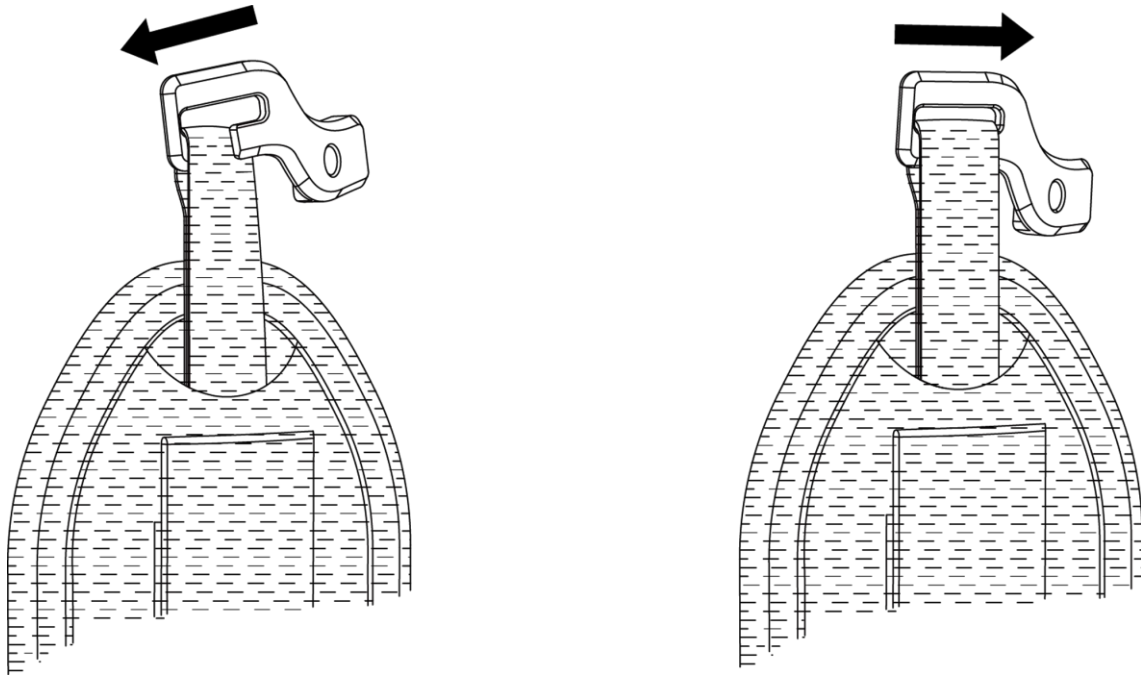

**Figure 2-3 Insert Upper Part of Hand Strap**

2. Fit the buckle on the device and tighten the screw with the supplied wrench.
3. Thread the lower part of the hand strap through the hole at the base of the device. Secure the hand strap with the hook-and-loop fastener.

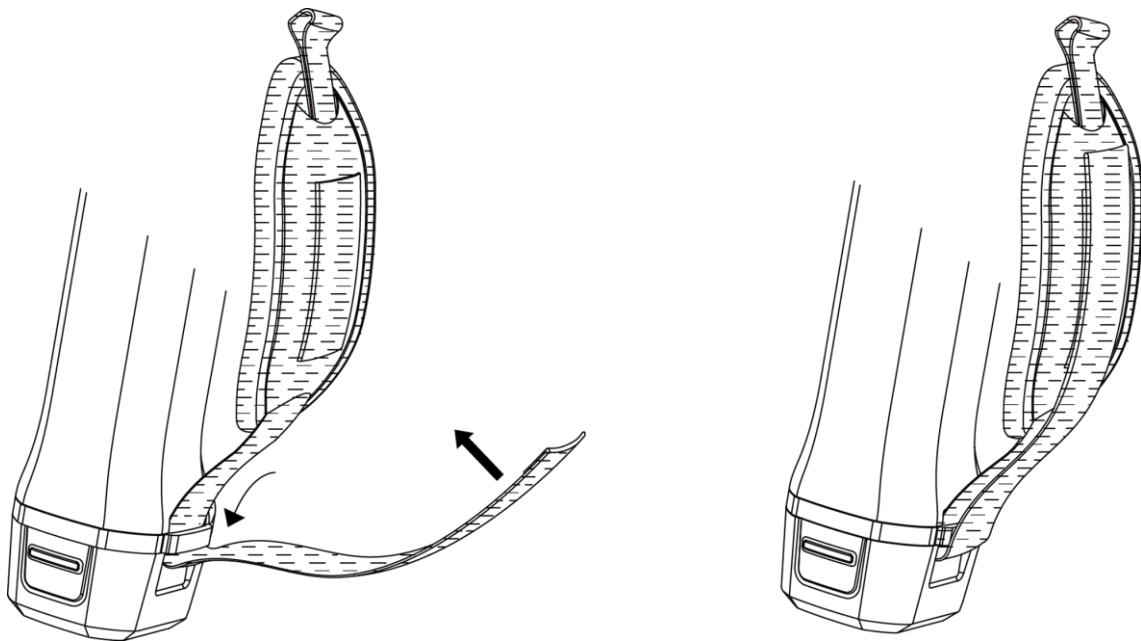

**Figure 2-4 Secure Lower Part of Hand Strap**

## 2.3 Mount Protective Cover

Attach the protective cover when the device is not in use.

### Steps

1. Align the threaded hole of the device with the mounting hole of the lens cover.
2. Insert the screw, and rotate it clockwise to fix the lens cover.

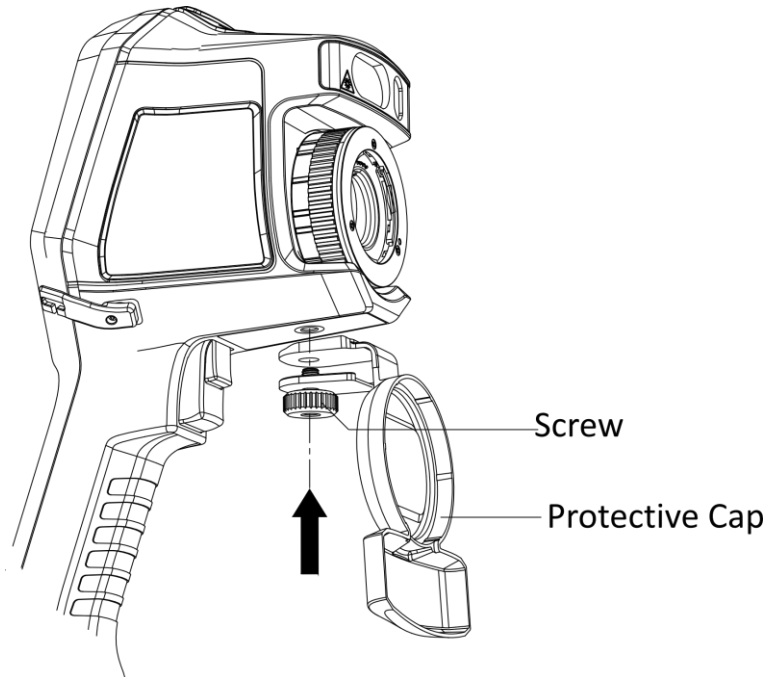

Figure 2-5 Fix Protective Cover

## 2.4 (Optional) Mount Interchangeable Lens

An interchangeable lens is an additional thermal lens that can be mounted to the device to change the original focal length to different ranges, so as to obtain different FOVs and scene scopes.

### Before You Start

- Purchase a suitable interchange lens recommended by the device manufacturer.
- The device pops up a window to show the lens information or the calibration program when detecting a mounted lens.

### Steps

1. Turn the decorative ring anticlockwise to remove it.

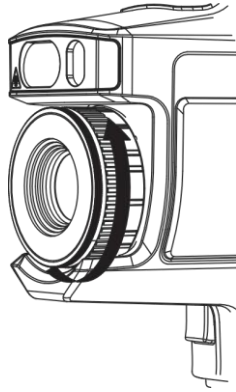

**Figure 2-6 Rotate the Decorative Ring**

2. Align the two dots on the interchangeable lens and the device.

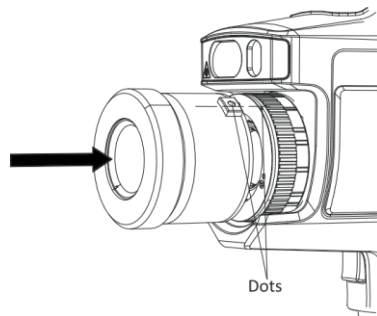

**Figure 2-7 Align the Dots**

3. Rotate the interchangeable lens clockwise to fix it.

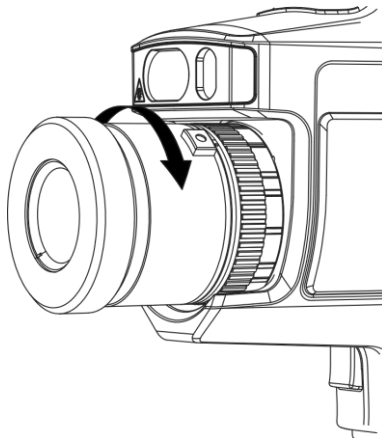

**Figure 2-8 Mount the Lens**

4. Optional: Rotate the interchangeable lens anticlockwise to dismount it.

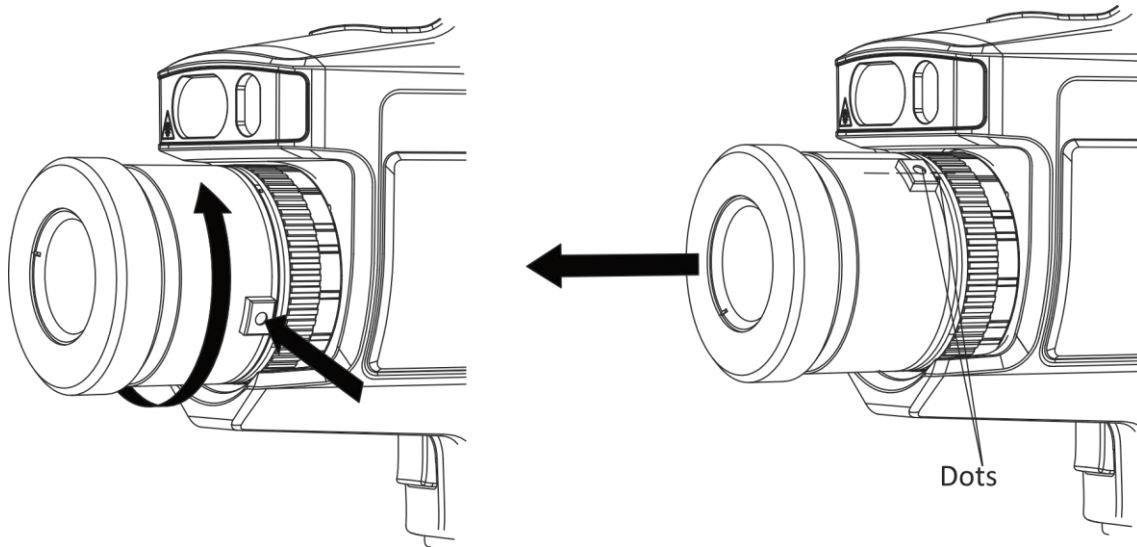

Figure 2-9 Dismount the Lens

---

**Note**

When a new interchangeable lens is mounted on the device, it takes about 2 minutes to achieve accurate temperature measurement. Before that, ~ is added before the temperature value. ~ disappears after the device can accurately measure the temperature.

---

**What to do next**

Calibrate the lens before you can use it normally. See [\*Calibrate Interchangeable Lens\*](#) for instructions.

### 2.4.1 Calibrate Interchangeable Lens

This part introduce how to calibrate a newly mounted interchangeable lens.

**Before You Start**

- Place the target plate on a flat surface with the "TARGET" facing the lens.
- Power on the target plate to heat it (12 VDC).
- Start the calibration when the temperature of the plate rises (about 1 minute later after powering on the plate).

**Steps**

1. Power on the handheld camera.
2. Follow the pop up interactive instructions to start the calibration.



**Note**

The instruction window pops up immediately after mounting the lens. If you accidentally exit the calibration program, go to **Settings** → **Capture Settings** → **Interchangeable Lens Calibration** to enter again.

3. Hold the camera and aim it at the target plate. The distance between the camera and target plate should meet the following requirement.

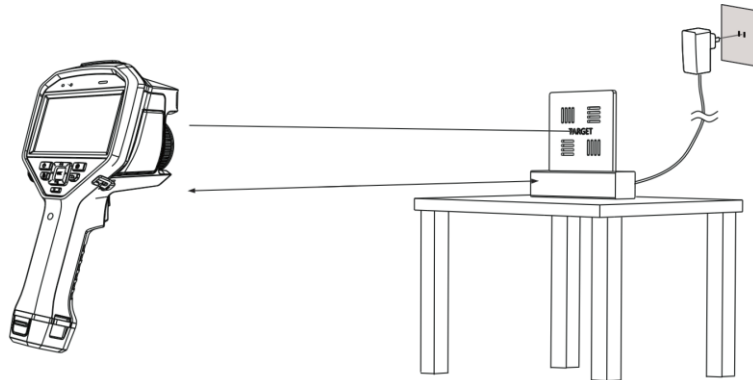

**Figure 2-10 Aim at the Target Plate**

**Table 2-1 Lens Specification and Distance**

Lens Specification	Distance
0.5×	0.5 m to 1.5 m
2×	1.5 m to 2.5 m
3.3×	3.0 m to 4.0 m

4. Press **OK**, and the camera emits a beam of red laser.
5. Slightly adjust the camera position to aim the red laser dot at the "TARGET" character on the plate and keep still for measuring the distance.

**Note**

- If the measurement succeeds, the distance is displayed on the screen. If it fails, adjust the distance and try again.
- It is recommended to use a tripod to fix the camera if keeping it still is difficult.

6. Use the left/right buttons or the focus ring to adjust the focus, and press **OK** after the "TARGET" is clear (as shown in the following image).

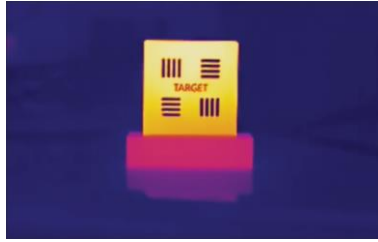

7. Adjust the target's optical image with navigation buttons until it overlaps with the thermal image, and press . The well-overlapped image is shown as follows.

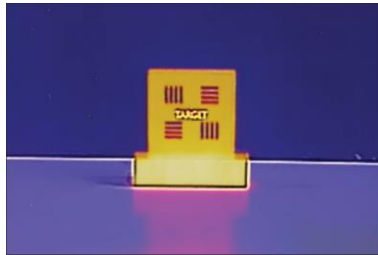

### What to do next

After the lens is calibrated, you can check the lens information at **Settings** → **Device Information** and see the lens type (0.5×, 2×, etc.) on the observation interface.

## 2.5 Power On/Off

### Power On

Remove the lens cover, and hold for over three seconds to turn on the device. You can observe the target when the interface of the device is stable.

---

#### Note

It may take at least 30 s until the device is ready for using when you power on it.

---

### Power Off

When the device is turned on, hold for three seconds to power off the device.

### 2.5.1 Set Auto Power-off Duration

Go to **Local Settings** → **Device Settings** → **Auto Off** to set the automatic shutdown time for device as required.

## 2.6 Operation Method

The device supports both touch-screen control and button control.

### Touch-screen control

Tap on the screen to set parameters and configurations.

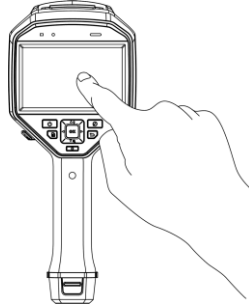

Figure 2-11 Touch-screen Control

### Button control

Press the navigation buttons to set parameters and configurations.

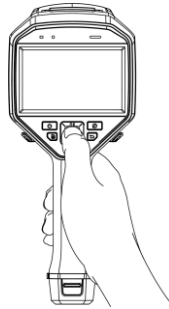

Figure 2-12 Button Control

- Press  $\triangle$ ,  $\nabla$ ,  $\triangleleft$ , and  $\triangleright$  to select parameters.
- Press  $\triangleright$  to enter the submenu.
- Press  $\triangleleft$  to return to the previous menu.
- Press  $\text{OK}$  to confirm.

## 2.7 Menu Description

In the observation interface, the left is the status display, and the right is shortcut keys. Tap the screen or press  $\text{OK}$  to show the menu bar.

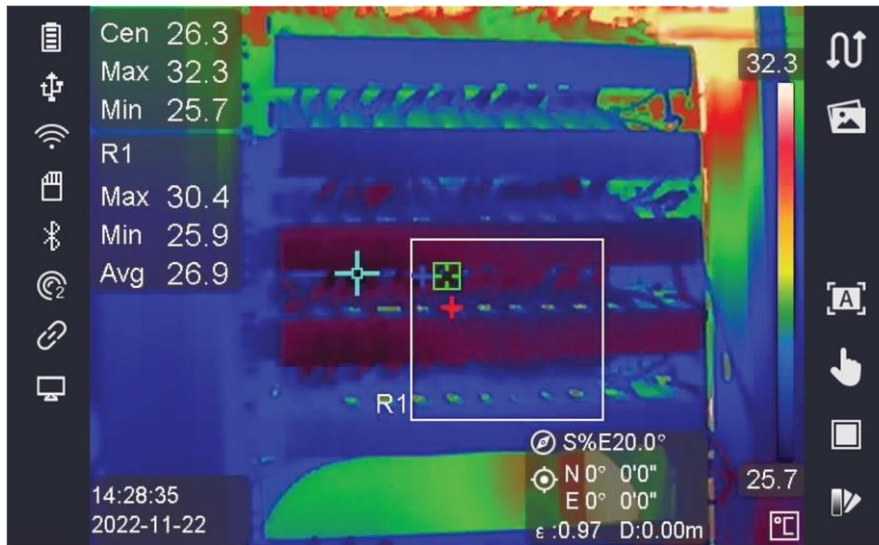

Figure 2-13 Menu















The description of status display and shortcut key is shown as follows. You can touch the shortcut key to switch modes on the interface.

Table 2-2 The Description of Status Display

Status Display	Description
	Battery Status
	The device is connected to PC via Type-C cable.
	Wi-Fi is connected.
	Memory Card is inserted.
	Bluetooth is on.
	Interchangeable Lens is mounted on the device and the interchangeable lens type is on the bottom right of the icon.
	The inspection data is transmitting to the device.
	Cast Screen is on.

Table 2-3 The Description of Shortcut Key

Shortcut Key	Description
	The device is in the inspection route mode. Tap the icon to enable/disable the inspection route mode.
	View the image of inspection point captured in

Shortcut Key	Description
	<p>the inspection route mode.</p>
	<ul style="list-style-type: none"> <li>•  means Autofocus,  means Continuous Autofocus, and  means Laser Assisted Focus.</li> <li>• Tap the icon to switch the focus mode. Refer to <b><u>Focus</u></b> for detailed operation.</li> </ul>
	<ul style="list-style-type: none"> <li>•  means Auto Mode of Level &amp; Span,  means Manual Mode of Level &amp; Span.</li> <li>• Tap the icon to switch the mode of Level &amp; Span. Refer to <b><u>Adjust Display Temperature Range</u></b> for detailed operation.</li> </ul>
	<ul style="list-style-type: none"> <li>•  means PIP (Picture in Picture) mode,  means Thermal mode,  means Fusion mode, and  means Optical mode.</li> <li>• Tap the icon to switch the display mode. Refer to <b><u>Set Display Mode</u></b> for detailed operation.</li> </ul>
	<p>Tap the  to switch the palette type.</p>

## Chapter 3 Display Settings

---

### Note

Your device will periodically perform a self-calibration to optimize image quality and measurement accuracy. In this process the image will pause briefly and you'll hear a "click" as a shutter moves in front of the detector. The self-calibration will be more frequent during start up or in very cold or hot environments. This is a normal part of operation to ensure optimum performance for your device.

---

### 3.1 Focus

Adjust the focusing to clearly display target objects before you doing other operations, or it may affect the image display and temperature accuracy.

#### 3.1.1 Focus Lens

##### Steps

1. Power on the device.
2. Aim the device lens to the appropriate scene.
3. Adjust the focus knob clockwise or anticlockwise, see figure below.

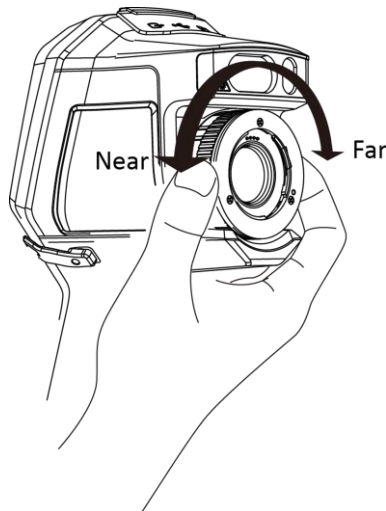

Figure 3-1 Focus Lens

## Note

DO NOT touch the lens to avoid affecting the display effect.



### 3.1.2 Laser Assisted Focus

Point the laser to the target and the device focuses automatically.

#### Before You Start

- It is recommended to use this function in a non-glare environment, such as indoor environment.
- The target should have good light reflection, such as white paper, cable.

#### Steps

1. Press  in live view.
2. Select , and go to **Capture Settings** → **Focus** → **Focus Mode** to enable **Laser Assisted Focus**.
3. In the live view interface, aim the image center at the target and hold the **Focusing Trigger**.
4. When you see a red dot display in the image center and a laser dot at the target, release the trigger to start focusing automatically.

---

#### Warning

The laser radiation emitted from the device can cause eye injuries, burning of skin or inflammable substances. Prevent eyes from direct laser. Before enabling the function, make sure no human or inflammable substances are in front of the laser lens.

---

5. Optional: If the focusing effect is not satisfactory, slightly adjust the focus ring for better image.

### 3.1.3 Auto Focus

The device focuses by comparing the brightness, contrast, etc. in current scene. In this mode, you can pull the trigger or touch the screen to focus.

Go to **Settings** → **Capture Settings** → **Focus** → **Focus Mode** to enable **Auto Focus**. Or you can switch the focus mode to auto focus through the shortcut key on the left menu bar.

Go back to the live view interface, aim the focus frame at the target, and hold the **Auto Focus Trigger** to focus. Release the trigger to finish focusing.

Or touch the object to be focused on the live view, then the focus frame moves to the target area, and the device focuses automatically.

---

## Note

- DO NOT adjust the focus ring in this mode, or it will interrupt the focus process.
  - The touch focus method is suitable for situations where the device is fixed to a certain place.
- 

### 3.1.4 Continuous Autofocus

In continuous autofocus mode, the device focuses on the target automatically to make the scene

clear. Use this mode when the device is stationary.

---

 **Caution**

Disable continuous autofocus mode when the device is moving, or it may affect the device function.

---

Go to **Settings** → **Capture Settings** → **Focus** → **Focus Mode** to enable **Continuous Autofocus**. Then aim the device at the target, and the device focuses automatically.

---

 **Note**

Focus ring adjustment does not take effect in this mode.

---

## 3.2 Set Screen Brightness

Devices support auto or manual screen brightness adjustment.

**Table 3-1 Screen Brightness Adjustment**

Method	Operation
Manual	Go to <b>Settings</b> → <b>Device Settings</b> → <b>Brightness</b> to adjust the screen brightness.
Auto	Go to <b>Settings</b> → <b>Device Settings</b> → <b>Brightness</b> to enable <b>Auto</b> . Devices adjust the screen brightness automatically when the ambient brightness changes.

 **Note**

The auto screen brightness adjustment function is only supported by devices with light sensors. Please take the actual device for reference.

---

## 3.3 Set Display Mode

You can set the thermal/optical view of the device. **Thermal**, **Fusion**, **PIP**, and **Optical** are selectable.

### Steps

1. Select  from the main menu.
2. Tap on the icons to select a view mode.



In thermal mode, the device displays the thermal view.

---







In fusion mode, the device displays the combined view of thermal channel and optical channel.



In PiP (Picture in Picture) mode, the device displays thermal view inside the optical view.

---

### Note

You can press  and  to set the PiP proportion. Or go to **Local Settings** → **Image Settings** → **PIP Proportion** to set the value.

---



In optical mode, the device displays the optical view.

3. Press  to exit.

## 3.4 Set Palettes

The palettes allow you to select the desired colors.

### Steps

1. Select  from the main menu.
2. Tap on the icons to select a palette type.

#### White Hot

The hot part is light-colored in view.

#### Black Hot

The hot part is black-colored in view.

#### Rainbow

The target displays multiple colors, it is suitable for scene without obvious temperature difference.

#### Ironbow

The target is colored as heated iron.

#### Red Hot

The hot part is red-colored in view.

#### Fusion

The hot part is yellow-colored and the cold part is purple-colored in view.

#### Rain

The hot part in the image are colored, and the else is blue.

3. Press  to exit the setting interface.

 **Note**

You can also press  on the live view interface to change the palettes.





### 3.4.1 Set Alarm Mode Palettes





Alarm mode palettes allows to mark the targets of certain temperature range with a different color from the rest.

**Steps**

1. Select **Palettes** from the main menu.
2. Tap the icons to select an alarm rule type.

**Table 3-2 Icon Description**

Icon	Alarm Mode	Description
	Above Alarm	Set the alarm temperature, and the targets with the temperature higher than the set value are displayed in red.
	Below Alarm	Set the alarm temperature, and targets with the temperature lower than the set value are displayed in blue.
	Interval Alarm	Set the alarm temperature section (e.g., 90 °C to 150 °C), and targets with the temperature in the range are displayed in yellow.
	Insulation Alarm	Set the alarm temperature section (e.g., 90 °C to 120 °C), targets with the temperature out of the section (e.g., 70 °C or 125 °C) are displayed in purple or blue.

3. Optional: Press  and  to select between upper limit and lower limit.
4. Press  and  to adjust the rule temperature.
5. Press  to exit.

### 3.4.2 Set Focus Mode Palettes



Focus mode palettes allows to mark the targets of certain temperature range with fusion palettes and the others with white hot palettes.





**Steps**

1. Select **Palettes** from the main menu.

2. Tap the icons to select an alarm rule type.

**Table 3-3 Icon Description**

Icon	Palettes Mode	Description
	Above Focus	Set the temperature threshold, and the targets with the temperature higher than the set value are displayed with fusion palettes.
	Below Focus	Set the temperature threshold, and targets with the temperature lower than the set value are displayed with fusion palettes.
	Interval Focus	Set the temperature range (e.g., 90 °C to 150 °C), and targets in the range are displayed with fusion palettes.

3. Optional: Press  and  to select between upper limit and lower limit.
4. Press  and  to adjust the rule temperature.
5. Press  to exit.

### 3.5 Adjust Digital Zoom

In the live view interface, press  to adjust the digital zoom to 1x, 2x, 4x, or 8x. Then you can view the target or scene in larger size.

### 3.6 Display OSD Info

Go to **Settings** → **Image Settings** → **Display Settings** to enable the information on-screen display.

#### Status Icon

The device status icons, for example, battery status, memory card, hotspot, etc.

#### Time

Device time and date.

#### Parameters

Thermography parameters, for example, target emissivity, temperature unit, etc.

#### Distance Value

Laser-measured target distance.

---

#### Note

It is only supported by device models with laser distance measuring function.

---

### **Brand Logo**

The brand logo is a manufacturer logo displayed on the upper right corner of the screen. You can turn it off if not needed.

## Chapter 4 Temperature Measurement

The thermography (temperature measurement) function provides the real-time temperature of the scene and display it on the left of your screen. The thermography function is turned on by default.

---

### Note

Your device will periodically perform a self-calibration to optimize image quality and measurement accuracy. In this process the image will pause briefly and you'll hear a "click" as a shutter moves in front of the detector. The self-calibration will be more frequent during start up or in very cold or hot environments. This is a normal part of operation to ensure optimum performance for your device.

---

### 4.1 Set Thermography Parameters

You can set thermography parameters to improve the accuracy of temperature measurement.

#### Steps

1. Go to **Local Settings** → **Thermography Settings**.
2. Set the **Thermography Range**, and **Emissivity**, etc.

#### Thermography Range

Select the temperature measurement range. The device can detect the temperature and switch thermography range automatically in **Auto Switch** mode.

#### Emissivity

Refer to [\*\*Common Material Emissivity Reference\*\*](#) to set the emissivity of your target.

#### Reflection Temperature

If any object (not the target) of high temperature is in the scene, and the target emissivity is low, set the reflection temperature as the high temperature to correct the thermography effect.

#### Distance

The distance between the target and the device. You can customize the target distance or select the target distance as **Near**, **Middle**, or **Far**.

#### Humidity

Set the relative humidity of current environment.

#### Optical Transmissivity

Set the optical transmissivity of external optical material (e.g.: germanium window) to improve the temperature measuring accuracy.

### External Optics Temperature

Set temperature of the external optical material (e.g.: germanium window).

3. Return to previous menu to save the settings.

---

#### Note

You can go to **Local Settings** → **Device Settings** → **Device Initialization** → **Measurement Tool Initialization** to initialize the temperature measurement parameters.

---

## 4.1.1 Set Unit

Go to **Local Settings** → **Device Settings** → **Unit** to set the temperature unit and distance unit.

---

#### Note

You can go to **Local Settings** → **Image Settings** → **Display Settings** to enable/disable the temperature display.

---

## 4.2 Adjust Display Temperature Range

Set a temperature section and the palette only works for targets within the temperature section. You can adjust the temperature range.

### Steps

1. Select **Level & Span**  from the main menu.
2. Select **Auto**  or **Manual** .





#### **Auto Adjustment**

Select , and press **OK**. The device adjusts display temperature range according to the actual targets temperature automatically.

#### **Manual Adjustment**

Select , and press **OK**.

There are 2 ways to adjust the range in this mode:

- Adjust the display temperature range based on a selected area. Tap on an interest area of the screen. A circle is displayed around the area, and the palettes readjusts to a temperature range to show as many details of the area as possible.
- Set the upper and lower limits of the temperature range manually.
  - Press  or  to select the upper limit, lower limit, or both. You can also tap on the temperature boxes at the ends of the palette bar to select them.
  - Press  or  adjust the temperature value. You can also tap on the arrows on the right side of the screen to adjust the temperature value.

3. Press  to exit.

### 4.3 Set Temperature Measurement Rule

You can set temperature measurement parameters to improve the accuracy of temperature measurement.

#### Steps

1. Select  from the main menu.
2. Set the point, line, or area rules.

The configured rule numbers are displayed near the rule icon.







Figure 4-1 Temperature Measurement Rule Settings

#### 4.3.1 Set Point Rule

You can set four types of point temperature measurement rules.

Table 4-1 Icon Description

Icon	Description
	Center Point Temperature Measurement
	High-temperature Point Temperature Measurement
	Low-temperature Point Temperature Measurement
	Custom Point Temperature Measurement

The setting methods of center point, high-temperature, and low-temperature point temperature measurement are all the same. Here is the example of setting high-temperature point temperature measurement.



#### Example

Tap  on the interface, the device locates the point of the highest temperature, and displays Max: XX.

## Custom Point Thermography

The device can detect the temperature of a custom point.

### Steps

1. Select .
2. Press .
3. Move the point with the navigation buttons or tap on the touch-screen to select a point.
4. Press .  
The temperature of custom point (e.g. P1) displays P1: XX.
5. Repeat step 1 to 3 to set other custom points.

---











### Note

At most ten custom points supported.

---

## 4.3.2 Set Line Rule

### Steps

1. Select .
2. Press  to generate a default line.
3. Move the line to the required position.
  - Tap the line, and press , , , and  to move the line up/down/left/right.
  - Tap the line on touch-screen and drag it to the required position.
4. Adjust the length of the line.
  - Tap the end of the line, and press , ,  to extend or shorten the line.
  - Tap and drag the end of the line to extend or shorten it.
5. Optional: Tap the line to set the **Emissivity** and **Distance** for the rule.
6. Press .

---

### Note

Only one line is supported.

---

The maximum temperature, minimum temperature, and average temperature of the line display in the top left corner of the screen. The real-time temperature trend chart will display near the line.









### What to do next

Displayed temperature types for the rule are configurable at **Local Settings** → **Thermography Settings** → **Temperature Display**.



### 4.3.3 Set Area Rule

#### Steps

1. Select .
2. Press  to generate a default frame.
3. Press , , , and  to move the frame up/down/left/right.
4. Press  to enlarge the frame, and press  to contract the frame. Or you can drag the corner of the frame on touch-screen to enlarge or contract the frame.
5. Press .  
The maximum temperature, minimum temperature, and average temperature of the framed area are displayed on the left of the screen.
6. Repeat steps to set other areas.

---

#### Note

At most three areas are supported.



---

#### What to do next

Displayed temperature types for the rule are configurable at **Local Settings** → **Thermography Settings** → **Temperature Display**.

### 4.3.4 Delete Rules

#### Delete All Rules

Tap  and press  to clear all temperature rules.

#### Delete One Rule

- In the rule setting mode, tap  and choose the single rule you want to delete.
- In the observation interface, tap on a rule (point, line or frame) and enter the editing mode. Tap **Delete** to delete the rule.

## 4.4 Calculate Area Size

The device can calculate the target size in the area, and display the result over the frame.

#### Steps

1. Go to **Local Settings** → **Device Settings** → **Area Size Calculation**.
2. Enable **Area Size Calculation**.
3. In the live view interface, aim a frame at the target and press the laser button.

---

#### Note

- The frame is the one that you draw in thermography frame rule. See **Set Area Rule** for

instructions. Make sure the lens is parallel to the target when measuring the area size.

---

The target size is displayed over the frame.

## 4.5 Temperature Alarm

When the temperature of targets triggers the set alarm, the device will perform configured actions, such as, flashing the rule frame, making an audible warning, or sending notification to the client software.

### 4.5.1 Set Alarms for Exceptional Temperatures

Alarm actions, such as, audible warning, sending notification to the client software, are triggered when the tested temperature exceeds the set alarm or alert value.

#### Steps

1. Go to **Settings** → **Thermography Settings** → **Alarm Settings**.
2. Enable the function and set the alarm threshold, alert threshold, and audible warning.

#### Alarm Threshold

When the tested temperature exceeds the threshold, the device sends alarm notification to the client software. It beeps if the audible warning is enabled. The frame flashes red if the frame rule is configured.

#### Alert Threshold

When the tested temperature exceeds the threshold, the device sends alert notification to the client software.

#### Audible Warning

The device beeps when target temperature exceeds the alarm threshold.

#### Alarm Capture

The device captures radiometric images when target temperature exceeds the alarm threshold.

#### Min. Alarm Interval

It controls the minimal time interval between two alarm information uploading. It helps reduce repeated and frequent information receiving on the part of APP and client software.

---

#### Note

If the area rules are set to measure temperature, the alarm threshold, alert threshold and audible warning settings only works in the framed areas. Otherwise, the parameters are valid for pixel-to-pixel temperature measurement (whole-screen temperature measurement).

---

## Chapter 5 Route Inspection

In certain situations that require temperature check for many inspect points, you can use the client software to create inspection routes that cover all the points and send a route inspection task to the device. After the device examines the temperatures of the inspect points, it uploads the results to the client software.

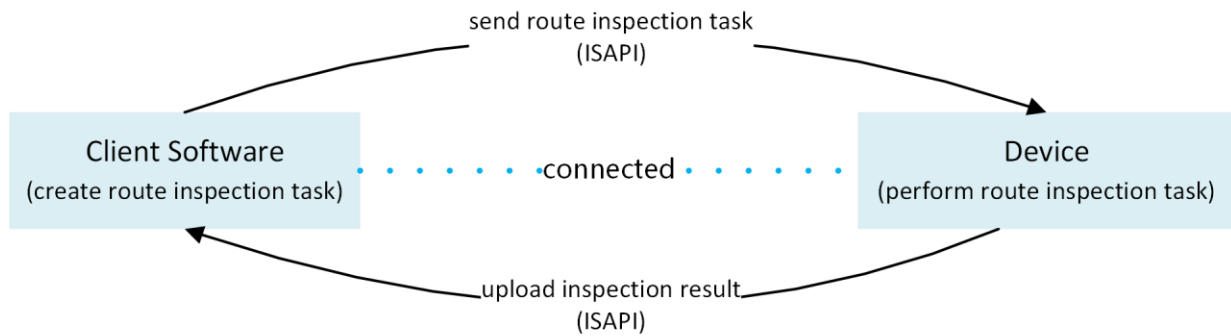

**Figure 5-1 Route Inspection Work Flow**

The device receives the tasks from and uploads the inspection results to the PC client software by its WLAN or Hotspot function.

### 5.1 Create Inspection Route and Send Task to Device

Create the inspection routes on HIKMICRO Inspector. The client should be connected to the device before sending the route inspection task.

#### Before You Start

Download the HIKMICRO Inspector from <http://www.hikmicrotech.com> and install the program to your PC.

The PC should support WLAN function.

#### Steps

1. Open HIKMICRO Inspector.
2. Create inspect points and routes. See the user manual of HIKMICRO Inspector for instructions.
3. Connect your device and PC to the same LAN. Available methods as below:
  - Connect your PC and your device to the same Wi-Fi network. For device Wi-Fi connection, go to **Settings** → **Device Settings** → **WLAN** to select and connect desired Wi-Fi network. See **Connect Device to Wi-Fi** for more instructions.
  - Connect your PC to the device hotspot. Turn on and set up device hotspot by **Settings** → **Device Settings** → **Hotspot**. See **Set Device Hotspot** for more instructions.
4. Click **Device Management** to add your device into the client. See the user manual of HIKMICRO Inspector for instructions.
5. Go to **Task Management** → **Route Management** to select a route and click **Apply to Device**.

### What to do next

Check your device to see if the task is successfully received.

## 5.2 Perform Route Inspection

After receiving inspection tasks from the PC client, you can hold the device and check the inspect points on the route. Upload the results when the inspection is finished.



### Before You Start

- Make sure your device has a memory card installed. See **Appearance** for instructions.
- Connect the device to the PC client, and make sure that your device has received inspection tasks from the PC client. See the user manual of HIKMICRO Inspector for instructions.

### Steps

1. Enter inspection mode to start.

Enter the mode by one of the following ways:

- Tap  at the upper right corner of the screen to enter the inspection route mode.
- Press  to call the menu, and go to **Settings** → **Device Settings** → **Inspection Route Mode** to enable the function.





---

### Note

- When in the inspection route mode, the device file are not accessible.
- When in the inspection route mode, settings of the following function are temporarily not changeable: **Photo Settings, QR Code**.

---

When in the inspection route mode, you can see  displayed at the upper right corner of the screen. You can tap the icon to exit the mode.

2. Select an inspection route task.
  - 1) Tap on live image or press  to call the menu of inspection route mode.
  - 2) Select  and then  to show currently received inspection route tasks.
  - 3) Select a task to start.
3. Select  or press  to see the inspect points that need to be checked in this task and go to the inspect points one by one.
4. Check the temperature of an inspect point and mark the result. Operations are different according to the check-in type and diagnosis type settings of each inspect point.

#### Check-In Type and Diagnosis Type

#### Operation

#### Check-in Required and Manual Diagnosis

1. In the live view interface, pull the main trigger to switch to the optical channel.
2. Aim the scanning frame to the QR code. The device will scan the QR code, and prompt the scanning result.

3. Pull the main trigger again to capture and mark the inspect point image. You can select **Normal**, **Emergency Defect**, **Severe Defect**, **General Defect**, or **Pending** from .

### Check-in Required and Auto Diagnosis

1. In the live view interface, pull the main trigger to switch to the optical channel.
2. Aim the scanning frame to the QR code. The device will scan the QR code, and prompt the scanning result.
3. Pull the main trigger again, then the device captures and automatically marks the inspect point image.

### Check-in Not Required and Manual Diagnosis

1. Aim the device to the inspect point.
2. Pull the main trigger to capture and mark the inspect point image. You can select **Normal**, **Emergency Defect**, **Severe Defect**, **General Defect**, or **Pending** from .

### Check-in Not Required and Auto Diagnosis

Aim the device to the target and pull the main trigger, then the device captures and automatically marks the inspect point image.

5. Save the capture.

After completing the current inspect point check, the device moves on to the next point automatically. Repeat the step to check other points.

6. Press  to see the captured image of every inspect point. Change the status if necessary.

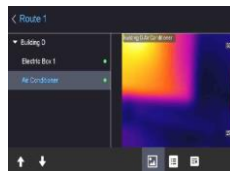

Figure 5-2 Check Inspection Result

### What to do next

Upload the results to the PC client after finishing the route inspection. See the user manual of HIKMICRO Inspector for instructions.

## 5.3 Upload Inspection Result and View Report

Upload the inspection results to the client software for central management and report

generation.

## Before You Start

Connect your device with the PC that has the client software installed. See the step of device connection in **Create Inspection Route and Send Task to Device** for instructions.

## Steps

1. Open HIKMICRO Inspector.
2. Click  and **Task Management** and check desired tasks.
3. Click **Read Inspection Result** to download the results from the device.

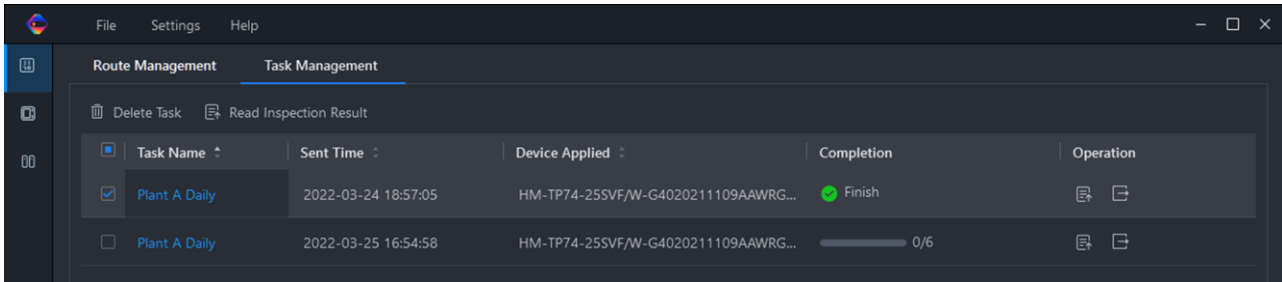

**Figure 5-3 Task Management**

The task status is shown in **Completion**.

4. Click on a finished task name to show result details.

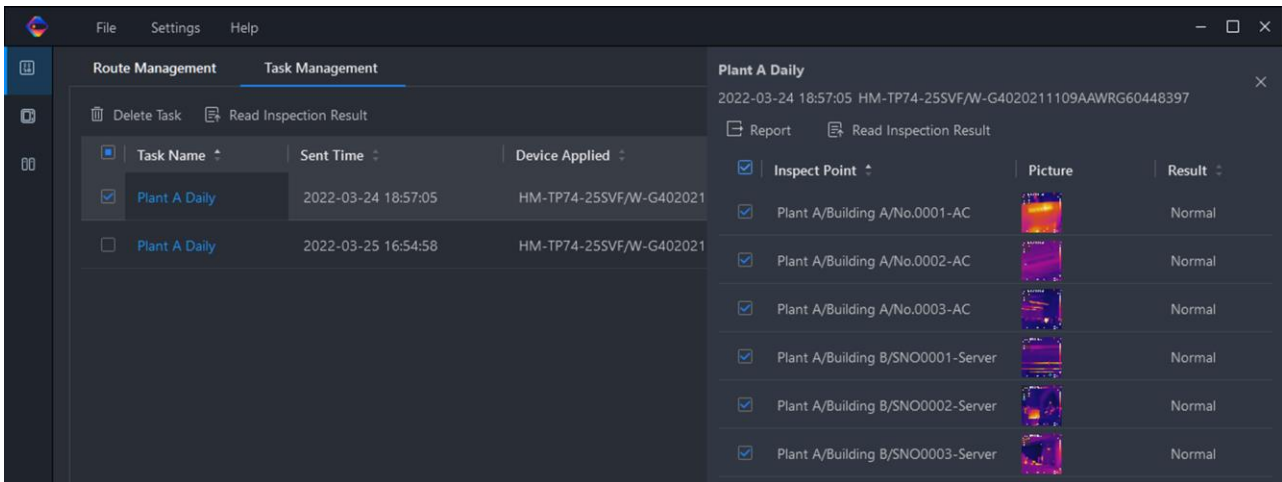

**Figure 5-4 Inspection Results**

5. Optional: Check a task or the desired inspect points and click **Report** for further analysis and report generation in HIKMICRO Analyzer.

## Note

- HIKMICRO Analyzer should be installed in your PC. Download the program from <https://www.hikmicrotech.com/>.
- For the operations instructions in HIKMICRO Analyzer, read the user manual from **Help** → **User Manual**.
- Please keep HIKMICRO Analyzer up-to-date for the best compatibility and user experience.

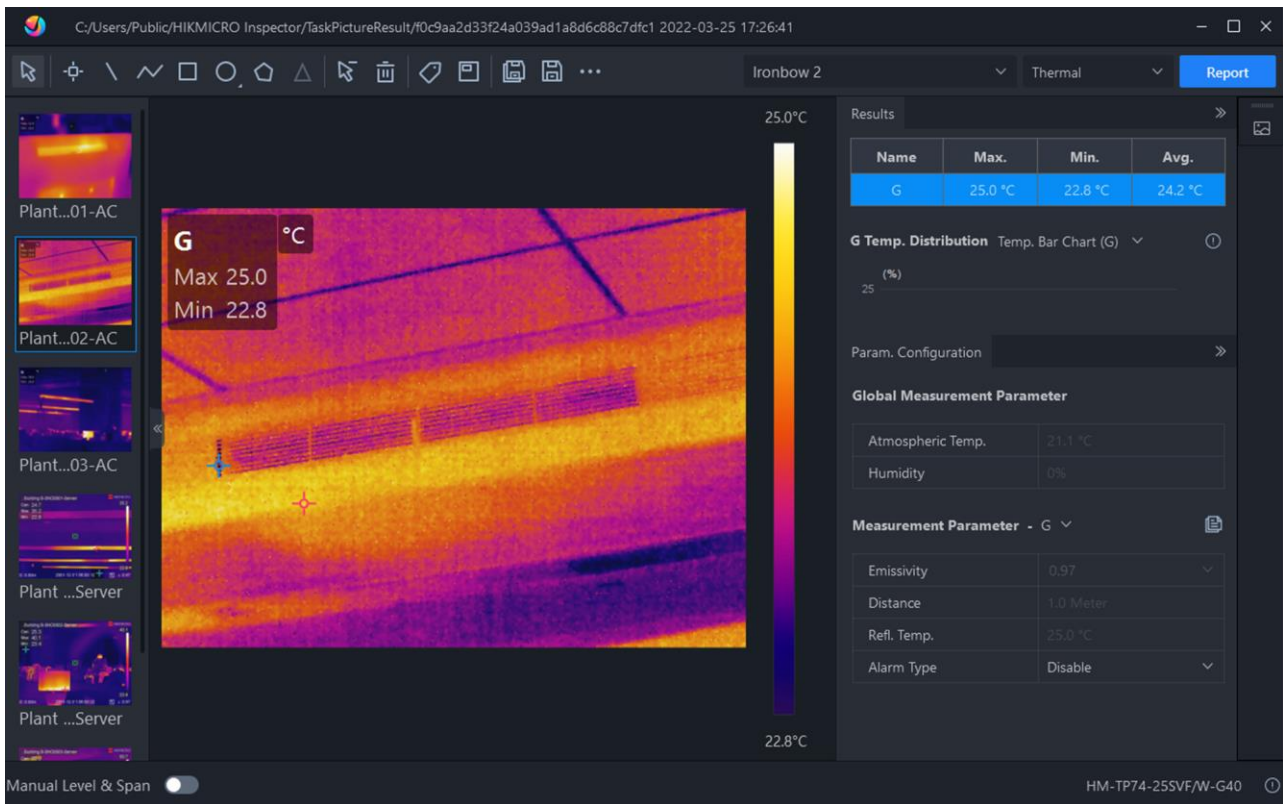

Figure 5-5 Analysis in HIKMICRO Analyzer

## Chapter 6 Picture and Video

Insert memory card into the device, then you can record videos, capture snapshots, and mark and save important data.

---

### Note

- Device does not support capturing or recording when the menu is shown.
- When the device is connected to your PC, it does not support capturing or recording.
- Go to **Local Settings** → **Device Settings** → **Filename Header**, you can set the filename header for capturing or recording to distinguish the files recorded in a specific scene.

Go to **Local Settings** → **Device Settings** → **Device Initialization** to initialize the memory card if needed.

---

### 6.1 Capture Picture

#### Before You Start

- A memory card should be mounted for picture storage.
- Disable QR Code function first.
- Go to **Local Settings** → **Capture Settings** → **Flashlight** to enable flashlight in dark environment.

#### Steps

1. Go to **Local Settings** → **Capture Settings**.
2. Select **Photo Settings** to set the capture mode.

**Single Capture**                      Capture one picture for one time.

**Continuous Capture**            Capture multiple pictures for one time. You can set the amount of pictures.

**Timed Capture**                    Device captures one picture after the specified time interval. You can set the time interval as needed.

3. Optional: Turn on **Super Resolution** if you need to export the captured thermal images and view them on a screen whose resolution is higher than the device.

The super resolution will be 4 times that of the original thermal image.

4. Optional: Set **Visible Image Resolution** for the captured optical image as needed.





5. Press  to exit.

6. In the live view interface, pull the trigger to capture snapshot.

7. The live view freezes and device displays the capture editing interface.

- 1) Tap  to add text remarks. Tap the screen to show the keypad interface, enter the comment and confirm.



- 2) Tap  to add voice remarks. Hold  to start recording and release the button to stop recording.
- 3) Tap  to add thermography rules. Refer to **Set Temperature Measurement Rule** for details.
- 4) Tap  or pull the trigger to save the snapshot.



---

### Note

You can also press  to quit the saving.

---



### Result

Press  or tap  in menu mode to check saved pictures. See **View Local Files** for more information.

## 6.2 Scan QR Code

Device can scan and capture the QR code.

### Steps

1. Press  in live view, and select .
2. Go to **Capture Settings**, and enable **QR Code**.
3. Press  to save and exit.
4. Aim the optical lens at the QR code, and press the main trigger. Then a rectangle shows on the screen and the device scans the QR code automatically.
5. After scanning the QR code successfully, press the main trigger again to capture and save the QR code.

---

### Note

Only supports scanning the QR code with up to 100 characters of text content.

---

## 6.3 Record Video

### Before You Start

- A memory card should be mounted for video storage.
- Go to **Local Settings** → **Capture Settings** → **Flashlight** to enable flashlight in dark environment if you want to record an optical video.

### Steps

1. Go to **Local Settings** → **Capture Settings** → **Video Type** to set the video format.

### Radiometric Video

Radiometric data is attached in videos of this format. They can only be played and further analyzed with HIKMICRO Analyzer.

## Note

- The frame rate of this format is 5 fps.
  - A video clip should be no longer than 10 minutes, and its size should be no larger than 4 GB.
  - When the storage space is smaller than 500 MB, radiometric video recording is not allowed. Accidentally stopped recordings are not saved.
- 

## MP4

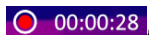
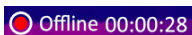

Recorded videos are saved in .mp4 format. These video clips can be played on local device, and any player that support this format (HIKMICRO Analyzer does not support playing this video format.).

2. In the live view interface, hold the trigger to start recording.

The recording signs for radiometric video and MP4 videos are different. When you see , it is recording a MP4 video. When you see , it is recording a radiometric video.

3. When you finish, pull the trigger again to stop recording. The video will be saved automatically and exit.
- 

## Note

You can also press  or  to stop recording.







---

## What to do next

Check the saved videos from  in menu mode. See [View Local Files](#) for more information.

## 6.4 View Local Files

### Steps

1. Select  from the main menu.
2. Press , , , and  to select video clips or snapshots.
3. Press  to view the file.

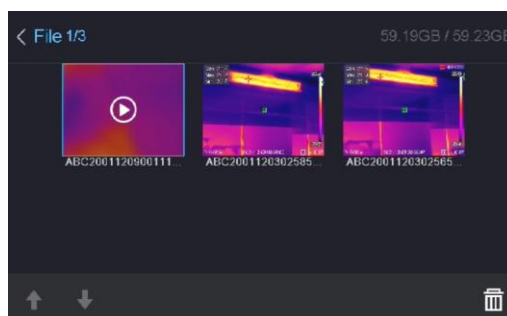





Figure 6-1 View Files

**Table 6-1 File Type and Description**

File Type	Description
Radiometric videos, format .rv	Radiometric videos clips are not supported playing on the device. To display these videos, you should export the videos to HIKMICRO Analyzer for display and analysis.
MP4 videos, format .mp4	Videos of this format can be played on local device, or exported to play by any other supported player. But, this format can not be played by HIKMICRO Analyzer
Radiometric images, format .jpeg	Images can be viewed on local device, or exported and analyzed in HIKMICRO Analyzer.

 **Note**

- Files are arranged in chronological order, with the most recent at the top. If you fails to find the most recently taken snapshots or videos, please check the time and date settings of your device. See **Set Date and Time** for instructions. When you are viewing files, you can switch to other files by tapping  or .
- When you are viewing snapshots with voice notes, You can tap  to play the sound. If you want to listen to the recorded sound in MP4 videos or with snapshots by bluetooth earphones or speakers, refer to **Connect Bluetooth** for instructions.
- For file exporting, see **Export Files** for instructions.
- For file analysis, download HIKMICRO Analyzer from our website <https://www.hikmicrotech.com/>.

## 6.5 Export Files

Connect the device to your PC with supplied cable, you can export the recorded videos and captured snapshots.

 **Note**

Cast screen should be turned off before exporting files. Go to **Local Settings** → **Device Settings** → **Cast Screen** to check the function status.

### Steps

1. Open the cover of cable interface.
2. Connect the device to your PC with cable and open the detected disk.
3. Select and copy the videos or snapshots to PC to view the files.
4. Disconnect the device from your PC.

---

 **Note**

For the first time connection, the driver will be installed automatically.

---

### **What to do next**

You can import the captured snapshots to HIKMICRO Analyzer for further data analysis. See the *User Manual of HIKMICRO Analyzer* (embedded in the client software, **Help** → **User Manual**) for the operation guide.



## Chapter 7 Distance Detection

The laser range finder consists of a laser transmitter and a laser receiver. The device detects the distance to a target by measuring the time it takes for a laser pulse to reach the target and return to the laser receiver. This time is converted to a distance, which is displayed on the screen.

### Before You Start

- It is recommended to use this function in non-glare environment, such as indoor environment.
- It is recommended that the target has good light reflection, such as white paper, cable.

### Steps

1. Press  in live view.
2. Select , and go to **Image Settings** → **Display Settings**.
3. Enable **Distance Value**.
4. Press  to save and exit.
5. In the live view interface, aim the cursor at the target and hold the laser button. Release the laser button to finish distance measurement.  
The distance displays on the screen when distance measurement is finished.

## Chapter 8 Geographic Location Display

Equipped with satellite positioning modules, the device is able to display its longitude and latitude on the live image and in the captured images.

---

### Note

The function is only supported by certain models.

---

Go to **Local Settings** → **Device Settings** → **GPS** to enable the satellite positioning modules, and you can see the location displayed at lower right corner of the screen.



**Figure 8-1 Location Display**

---

### Note

- The satellite module is not able to receive signals when the device is indoor. Place the device in an empty outdoor space to receive signals.
  - In an outdoor space, wait for a moment for the device to display its location.
  - The location information is also attached in captured radiometric images. You can read the location by HIKMICRO Analyzer.
  - Location display is only supported by models with satellite positioning modules.
-

## Chapter 9 Direction Display

Equipped with a compass, the device is able to display its direction on the live image and in the captured images.

---

### Note

The function is supported by certain models.

---

Go to **Local Settings** → **Device Settings** → **Compass** to enable the compass modules, then follow the pop-up instructions to calibrate the compass. See [Calibrate Compass](#) for more information. After successful calibration, you can see the direction displayed at lower right corner of the screen. It is recommended to read the direction when you lay the device horizontally.

To increase the direction accuracy, you can set the magnetic declination correction. See [Magnetic Declination Correction](#) for instructions.

---

### Note

The direction information is also attached in captured radiometric images. You can read the direction by HIKMICRO Analyzer.

---

### 9.1 Calibrate Compass

Compass calibration is a must for correction direction display.

You need to calibrate the compass when you enable the function for the first time or when the compass status shows **Not Calibrated**.

#### Steps

1. Call the calibration guide by the following ways.
  - When you enable compass for the first time, or the compass is magnetically interfered, compass calibration guide pops up.
  - Go to **Local Settings** → **Device Settings** → **Compass** to turn the function off and on again when the status shows **Not Calibrated**.
2. Follow the screen instructions to move and rotate the device.

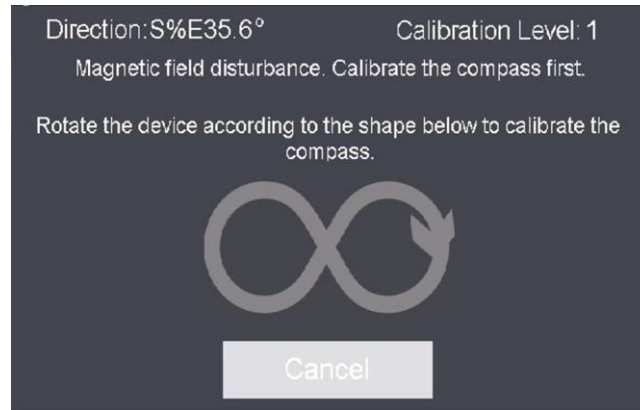

---

### Note

- During calibration, keep moving and rotating the device to make sure that the device faces every possible directions.
  - **Calibration Level** indicates the validity of calibration, higher level means more accurate compass reading. Calibration succeeds when the **Calibration Level** turns to **3**.
- 

3. Stop moving the device when calibration success message pops up.

### Result

Compass status turns to **Calibrated** on the settings page.

## 9.2 Magnetic Declination Correction

Magnetic declination is the angle variation between magnetic north and true north. Adding the magnetic declination to the compass increase the accuracy of direction reading.



Go to **Local Settings** → **Device Settings** → **Compass** → **Magnetic Declination Correction** to add the declination of device location.



## Chapter 10 Connect Bluetooth

You can use the bluetooth headset to play the audio recorded together with the videos and the images.

### Steps

1. Select  from the main menu.
2. Go to **Local Settings** → **Device Settings** → **Bluetooth**.
3. Tap on  to enable the bluetooth.

---



### Note

You can also press  or **OK** to quit pairing.

---

The device will search the nearby enabled bluetooth headsets and pair them automatically.

## Chapter 11 Set LED Light

Go to **Local Settings** → **Device Settings** → **Light Supplement**. Tap  to enable LED light, or press  in the live view to enable/disable the LED light.

## Chapter 12 Cast Device Screen to PC

The device supports casting screen to PC by UVC protocol-based client software or player. You can connect the device to your PC via a type-C cable, and cast the real-time live view of the device to your PC.

### Steps

1. Go to **Local Settings** → **Device Settings** → **Cast Screen** to turn on the function on device.
2. Open the UVC protocol-based client software on your PC.
3. Use a type-C cable to connect your device with PC.

### What to do next

For more instructions about how to cast the screen, please visit our website:

<https://www.hikmicrotech.com/>

## Chapter 13 Connect Device to Wi-Fi

### Steps

1. Go to **Settings** → **Device Settings** → **WLAN**.
2. Tap  to enable Wi-Fi, and the searched Wi-Fi will be listed as below.

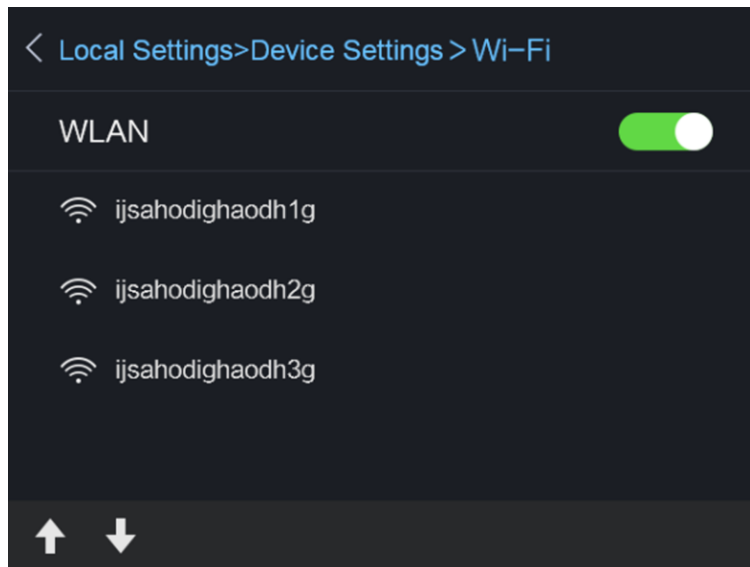

Figure 13-1 Wi-Fi List

3. Select Wi-Fi and enter password.

---

#### **Note**

DO NOT tap **enter** or **space**, or the password may be incorrect.

---

4. Tap **Close** to hide the keypad.
5. Tap **OK**.

---

#### **Note**

It takes about 1 minute at most to connect the device to the selected Wi-Fi. Leaving the Wi-Fi setting page does not interrupt the connection.

---

### Result

A Wi-Fi icon shows on the main interface when the connection is completed.

## Chapter 14 Set Device Hotspot

With the device hotspot, other equipment with Wi-Fi function can join the device for data transmission.

### Steps

1. Go to **Settings** → **Device Settings** → **Hotspot**.
2. Tap  to enable hot spot function.
3. Tap **Set Hot Spot** to set the hot spot name, encryption and password.

---

### Note

- When setting password, DO NOT tap **enter** or **space**, and at least 8 characters, or the password may be incorrect.
  - Tap **Close** to hide the keypad after finishing.
- 

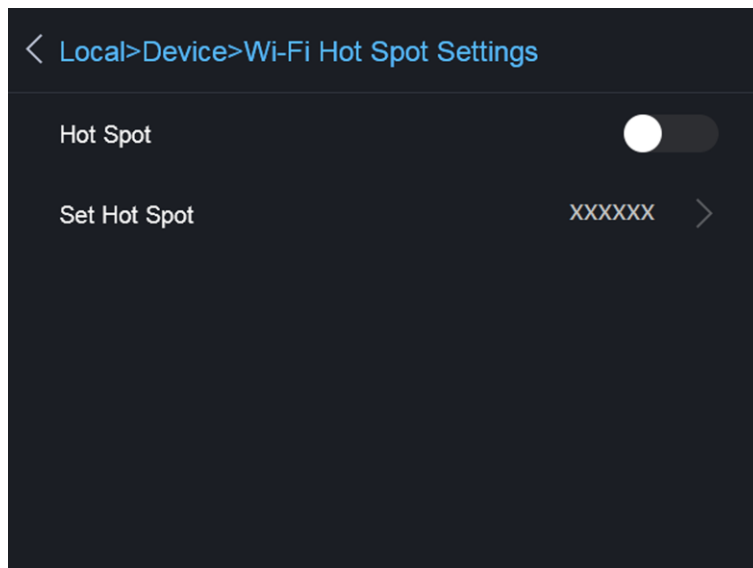

Figure 14-1 Set Hot Spot

## Chapter 15 Thermal View Mobile Client Connection

The device supports both Wi-Fi connection and hot spot. Connect the device to HIKMICRO Viewer, and you can control the device via mobile client.

### 15.1 Connect via Wi-Fi

#### Before You Start

Download and install HIKMICRO Viewer on your phone.

#### Steps

1. Connect your device to a Wi-Fi network. See [\*\*\*Connect Device to Wi-Fi\*\*\*](#) for instructions.
2. Connect your phone to the Wi-Fi network that the device is in.
3. Launch the app and follow the startup wizard to create, and register an account.
4. Search and add the device to the mobile client.

#### Result

You can view the live view, capture snapshots, and record videos via the client.

### 15.2 Connect via Hot Spot

#### Before You Start

Download and install HIKMICRO Viewer on your phone.

#### Steps

1. Turn on the device hop spot and complete hot spot settings. See [\*\*\*Set Device Hotspot\*\*\*](#) for instructions.
2. Connect your phone to the Hot Spot of the device.
3. Launch the app and follow the startup wizard to create, and register an account.
4. Search and add the device to the mobile client.

#### Result

You can view the live view, capture snapshots, and record videos via the client.



## Chapter 16 Image Local Output

You can view the image on the display unit for details with this function.

### Before You Start

- This function is only supported by the models with CVBS out interface or micro HDMI output interface.
- If your device has a micro HDMI output interface, connect the device and a display unit to cast the image. No more settings are required. If your device has CVBS out interface, connect the device and the display unit via a CVBS cable, and set the device according to the steps below.
- Make sure the device is turned off when connecting the cable.

### Steps

1. Go to **Local Settings** → **Image Settings** → **CVBS Output**.
2. Tap  to enable CVBS output.
3. Press  to save and exit.

The display unit show the device image.

## Chapter 17 Maintenance

### 17.1 View Device Information

Go to **Local Settings** → **Device Information** to view the device information.

### 17.2 Set Date and Time

#### Steps

1. Go to **Local Settings** → **Device Settings** → **Time and Date**.
2. Set the date and time.
3. Press  to save and exit.

---

#### Note

Go to **Local Settings** → **Image Settings** → **Display Settings** to enable or disable time and date display.

---

### 17.3 Upgrade Device

#### Steps

1. Connect the device to your PC with cable and open the detected disk.
2. Copy the upgrade file and paste it to the root directory of the device.
3. Disconnect the device from your PC.
4. Reboot the device and then it will upgrade automatically. The upgrading process will be displayed in the main interface.

---

#### Note

After upgrading, the device reboots automatically. You can view the current version in **Local Settings** → **Device Information**.

---

### 17.4 Restore Device

Go to **Local Settings** → **Device Settings** → **Device Initialization** to initialize the device and restore default settings.



## 17.5 Initialize Memory Card

When a memory card is use on the handheld thermal camera for the first time, it needs to be initialized first.

Go to **Local Settings** → **Device Settings** → **Device Initialization** to initialize the memory card.

---

### **Caution**

If there are files in the memory card, make sure that the files has been backed up before memory card initialization. Once the card is initialized, data and files can not be recovered.

---

## 17.6 About Calibration

We recommend you send the device back for calibration once a year, and please contact the local dealer for the information on maintenance points. For more detailed calibration services, please refer to <https://www.hikmicrotech.com/en/calibrationservices/2>.

## Chapter 18 Appendix

### 18.1 Common Material Emissivity Reference

Material	Emissivity
Human Skin	0.98
Printed Circuit Board	0.91
Concrete	0.95
Ceramic	0.92
Rubber	0.95
Paint	0.93
Wood	0.85
Pitch	0.96
Brick	0.95
Sand	0.90
Soil	0.92
Cloth	0.98
Hard Paperboard	0.90
White Paper	0.90
Water	0.96

### 18.2 FAQ

Scan the following QR code to get device common FAQ.



## 18.3 Device Command

Scan the following QR code to get device common serial port commands.

Note that the command list contains the commonly used serial port commands for HIKMICRO thermal cameras.



## 18.4 Device Communication Matrix

Scan the following QR code to get device communication matrix.

Note that the matrix contains all communication ports of HIKMICRO thermal cameras.





**HIKMICRO**

See the World in a New Way