



Food Preparation Machines
Made in Sweden



Vegetable Preparation Machine RG-200

- Slices, dices, shreds, grates, cuts julienne and crimping slices.
- Processes fruit, vegetables, dry bread, cheese, nuts, mushrooms, etc.
- Table top machine made for commercial use and long life.
- High capacity. Processes up to 700 portions/day and 7 kg/minute.



RG-200



Size that matters

RG-200 is designed to suit the kitchen with smaller volumes but who needs the quality and power of a large professional vegetable preparation machine. The size makes the machine suitable to use directly on a kitchen workbench. The leaning design means that the feed cylinder is always positioned at the right angle making it is easy to top up.

Safe and quick top ups

Thanks to the automatic start and stop function the machine stops as soon as the pusher plate is swung aside. When it is swung back the machine restarts and you can continue working. The RG-200 also has a full moon cylinder that can hold larger quantities and whole products. Features like these are a clear advantage, particularly when larger volumes are involved.

Double safety against unprotected cutting tools

If the feed cylinder is removed the power is cut. Thanks to this double security there is no risk of the machine starting with an unprotected cutting tool.

Developed for the best hygiene

The RG-200 is manufactured solely from hygiene certified material. The machine has smooth surfaces, rounded edges and has no unnecessary recesses where food might penetrate and get stuck.

Easy cleaning

For quick cleaning are all loose parts simple to remove for easy rinsing of the machine. The feed cylinder is removable and can be cleaned under running water.

Only the best material

Machine base, feed cylinder and pusher plate are all made of robust metal. Only top quality stainless steel is used to manufacture the cutting tool knife blades.

Lightweight and easy to move

The relatively small size of the machine gives several advantages. It does not take up a lot of space in the kitchen. You can use it as a table top machine. And it is easy to move, something which is helped by the generously sized handle on the back.

Highest possible reliability

The powerful motor has a high starting and running torque and powers the direct-driven cutting tool. No belts or intermediate connections. The power from the motor goes via a maintenance free gear drive. This makes the RG-200 an exceptionally reliable machine – irrespective of the products you are preparing.

Cutting tools with complete register

Our wide range of cutting tools means the RG-200 can handle every conceivable task. You choose the cutting tool you need to make you even more efficient in the kitchen. The RG-200 slices, dices, shreds, grates, makes juliennes and crimping slices – everything from firm to soft products. The knife blades and grating plates are replaceable. As a result you do not need to buy new cutting tools.

Always perfect cutting results

The rotation speed of the cutting tools is optimised for cutting fine and even slices as efficiently as possible. The knife blades are purposely sharpened to avoid inertia or the edge breaking off.



Accessories



Machine Table



Container Trolley



Pipe Insert for thin vegetables



Angle cut Feed head



















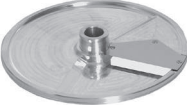





Wall rack

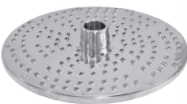

Brush

High quality cutting tools for best results

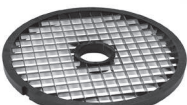
All cutting tools are dishwasher safe. • = Stainless steel

	Slicer • 0.5, 1, 1.5, 2, 3, 4, 5, 6, 7, 8, 9, 10 mm.	Are designed to slice firm and soft vegetables, fruits, mushrooms etc. Dices when combined with a suitable Dicing Grid. Cut French fries in combination with French Fry Grid.	
	Standard Slicer 20 mm.	Are designed to slice firm products, such as root vegetables etc. Dices when combined with a suitable Dicing Grid.	
	Fine Cut Slicer 15 mm.	Are designed to slice firm and soft vegetables, fruits, mushrooms etc. Dices when combined with a suitable Dicing Grid.	
	Soft Slicer 8, 10, 12, 15 mm.	Are designed to slice soft vegetables, fruits, mushrooms etc. Preferably used when dicing soft products, in combination with a suitable Dicing Grid.	
	Crimping Slicer • 2, 3, 4, 5, 6 mm.	Cut decorative rippled slices of beetroot, cucumber, carrots, etc.	
	Julienne Cutter • 2x2, 2x6, 3x3, 4x4, 6x6, 8x8, 10x10 mm.	Cut julienne of firm products for soups, salads, stews, decorations etc. Suitable to cut slightly curved French fries.	
	Grater/Shredder • 1.5, 2, 3, 4.5, 6, 8, 10 mm.	Grates carrots and cabbage for raw salads. Grates nuts, almonds and dry bread. Grater 6 or 8 mm is commonly used for grating cheese for pizza and when shredding cabbage.	
	Fine Grater •	For finely grating products, from hard/dry cheeses, raw potatoes for Swedish potato pancakes and bread for making breadcrumbs.	
	Hard Cheese Grater •	Ideal for grating hard cheese such as parmesan. Produces a somewhat coarser grate than the Fine Grater, Extra fine.	
	Fine Grater, Extra fine •	Grates products very finely, such as black radish grated for purée and potatoes for mashing.	
	Dicing Grid 6x6, 8x8, 10x10, 12x12, 15x15, 20x20 mm.	Are designed to cut dices in combination with a suitable type of slicer. Dice both hard and soft vegetables, fruits etc.	

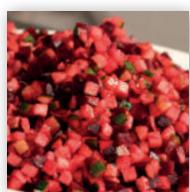
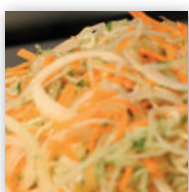
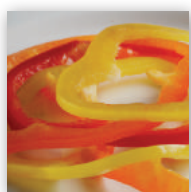
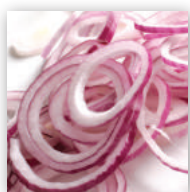

Take a look at result- and inspiration videos at our homepage, hallde.com ►





Vegetable Preparation Machine RG-200

- Large full moon shaped feed cylinder that can take most items whole.
- Direct driven cutting tools from a strong heavy duty motor with planetary gear transmission.
- Leaning design reduces stress on shoulders and back when the machine is being refilled.
- Angle top Feed head as an accessory for cutting angle shaped slices. Good for Asian wok dishes or for different types of soup.
- Detachable support wall enables easy piling of tomatoes, onions, bell peppers etc. for oriented slicing or to fit larger products whole such as lettuce or cabbage.
- Table top model that can be used on a kitchen workbench.

Machine

- Motor: 0.25 kW. One-speed. 100 V, single phase, 50-60 Hz. 110-120 V, single phase, 60 Hz. 220 V, single phase, 50 Hz. 230-240 V, single phase, 50 Hz. 230 V, three phase, 50 Hz. 400 V, three phase, 50 Hz. 440 V, three phase, 60 Hz.
- Transmission: Planetary gearing.
- Safety system: Two safety switches.
- Degree of protection machine: IP44.
- Degree of protection push buttons: IP65.
- Power supply socket: Earthed, single phase, 10 A.
- Fuse: 10 A, delayed action fuse.
- Sound level LpA (EN31201): 73 dBA.
- Magnetic field: Less than 0.5 microtesla.

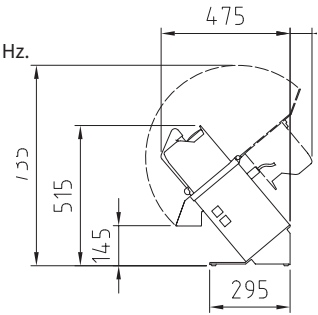

Materials

- Machine housing: Anodized and polished aluminium alloy.
- Ejector plate: Acetal
- Cutting tool discs: Stainless steel/ Aluminium/ Fibreglass reinforced polyamide
- Cutting tool knife blades: Stainless knife steel.
- Machine table: Stainless steel.
- Container: Polycarbonate.

Feeder

- Feed cylinder: Volume 3 litre. Height 185 mm. Diameter 170 mm.
- Feed tube with internal diameter 56 mm.

Cutting tools

- Diameter: 185 mm.
- Speed: 350 rpm (50 Hz), 420 rpm (60 Hz).

Type of preparation

- Slices, dices, grates, shreds, cuts julienne and crimping slices.
- Processes vegetables, fruit, dry bread, cheese, nuts, mushrooms, etc.

Users

- Restaurants, shop kitchens, diet kitchens, retirement homes, hospitals, schools, fast food outlets, catering, day care centres, salad bars, pizzerias, ships, etc.

Net weights

- Machine: 18 kg.
- Cutting plates: 0.5 kg.

Standards

- Directive: Visit hallde.com. Select product and "Certificate".

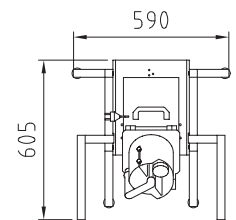
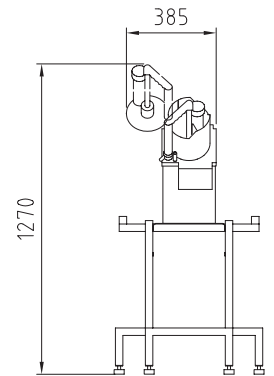
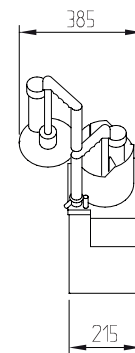

Food Preparation Machines
Made in Sweden

Available Australia wide from

FSM

21-23 Agosta Drive, Laverton North, Victoria 3026
Tel: (03) 9368 2300
www.fsm-pl.com.au sales@fsm-pl.com.au

Office and warehouse facilities in Melbourne, Sydney, Adelaide, Brisbane & Perth - Service Australia Wide

AB Hallde Maskiner - P.O. Box 1165 SE-164 26 Kista Sweden
• Phone: +46 8 587 730 00 • Fax: +46 8 587 730 30 • hallde.com • info@hallde.com