



# DYNACO D-311

**Gravity  
driven**

low friction technology



inside door

# DYNACO D-311

The Dynaco D-311 LF is designed for inside applications. It requires little space and protects your environment against drafts, humidity, dust and dirt. Operating speed and superior sealing properties improve your traffic flows and provide employee comfort, environmental control and savings on energy costs.

The patented «LF» (Low Friction) technology, combined with a frequency inverter driven motor, assures a smooth operation.

- **OPENING SPEED:**  
Up to 2,0 m/s.
- **SUPERIOR SEAL:**  
The patented side guides and «BEAD» technology allow energy savings.
- **CRASH FORGIVING AND SELF-REINSERTING WITHOUT INTERVENTION:**  
The curtain automatically reinserts itself when dislodged. No repair costs, no production down time.
- **USER SAFETY:**  
Flexible curtain without rigid elements.
- **COMFORT OF USE:**  
DYNACO wireless detector at the bottom.
- **ADVANCED DRIVE:**  
Frequency driven motor and encoder for smooth operation and reliability. Wearable elements are reduced to a minimum.
- **DYNALOGIC CONTROL BOX:**  
User-friendly control box with self-diagnosis.
- **CONFORM TO EN13241-1**

Printable curtain



Low friction side guide

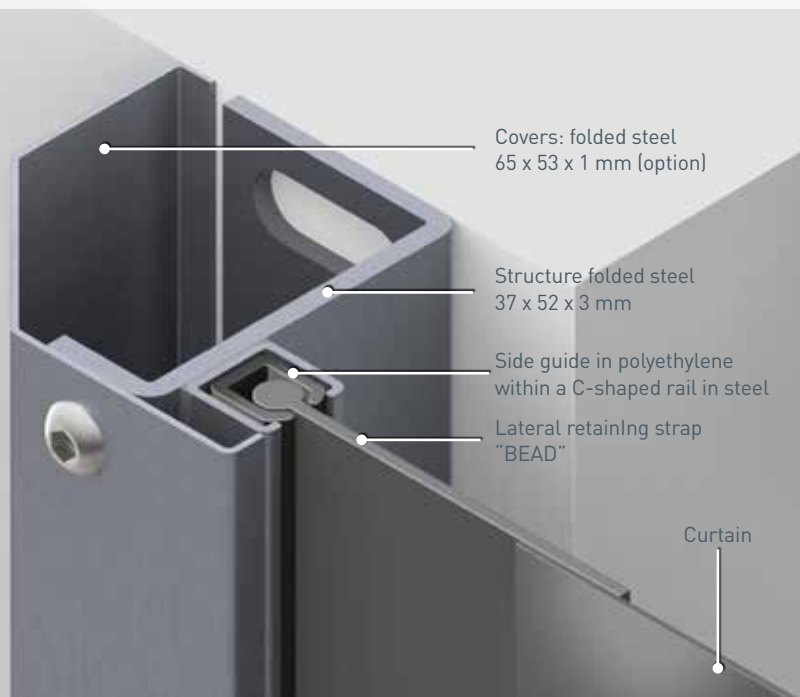

# Gravity driven

low friction technology



inside door

























## EN13241-1 STANDARDS

Standard	Ref.	Test acc.	Results
Water permeability	EN 12425	EN 12489	Class 2
Wind load	EN 12424	EN 12444	Class 1*
Wind permeability	EN 12426	EN 12427	Class 1**
Safe openings	EN 12453	EN 12445	Pass
Mechanical resistance	EN 12604	EN 12605	Pass
Unintended movements	EN 12604	EN 12605	Pass
Thermal transmittance	EN 12428	EN 12428	6,02 W/m <sup>2</sup> K
Performance (cycles)	EN 12604	EN 12605	1.000.000

\* Interior applications only

\*\* Valid for a door of 3500 x 3500mm

## CHARACTERISTICS

<b>Max. dimensions</b>	W 4.000 mm x H 4.000 mm																
<b>Opening speed</b> <b>Closing speed</b>	up to 1,2 m/s (optional 2,0 m/s) 0,5 m/s																
<b>Structure</b>	Folded steel 37 x 52 x 3 mm, galvanised before cutting and folding. Option: stainless steel																
<b>Drum</b>	Steel - Ø 102 x 2 mm.																
<b>Side guides</b>	Reinforced polyethylene (PE-UHMW1000)																
<b>Motor</b>	2 poles, without brake. Power 0,75 kW. IP rating: IP 65																
<b>Control box</b>	DYNALOGIC provided with: Circuit breaker, general divider, adjustable timer, push button for opening and reset and emergency stop. IP rating: IP 54. Frequency inverter.																
<b>Standard detectors</b>	Infrared barrier: 300 mm from the floor. Wireless DYNACO detector (WDD) DBD: correct unwinding detector																
<b>Power supply</b> <b>Frequency</b>	Single phase 230 V - 14 A. Frequency: 50-60 Hz																
<b>Advised operating temperature</b>	+ 5 °C up to + 40 °C																
<b>Available colours</b> comparable with:	<table border="0"> <tr> <td>Yellow RAL1003</td> <td></td> <td>Green RAL6005</td> <td></td> </tr> <tr> <td>Orange RAL2004</td> <td></td> <td>Grey RAL7035</td> <td></td> </tr> <tr> <td>Red RAL3000</td> <td></td> <td>White RAL9010</td> <td></td> </tr> <tr> <td>Blue RAL5002</td> <td></td> <td>Black RAL9005</td> <td></td> </tr> </table>	Yellow RAL1003		Green RAL6005		Orange RAL2004		Grey RAL7035		Red RAL3000		White RAL9010		Blue RAL5002		Black RAL9005	
Yellow RAL1003		Green RAL6005															
Orange RAL2004		Grey RAL7035															
Red RAL3000		White RAL9010															
Blue RAL5002		Black RAL9005															
(Actual colours may deviate. Colour samples available upon request)																	

Easy to clean



Reintroduction block<sup>PT</sup>



## Dimensions and installation requirements Dynaco D-311

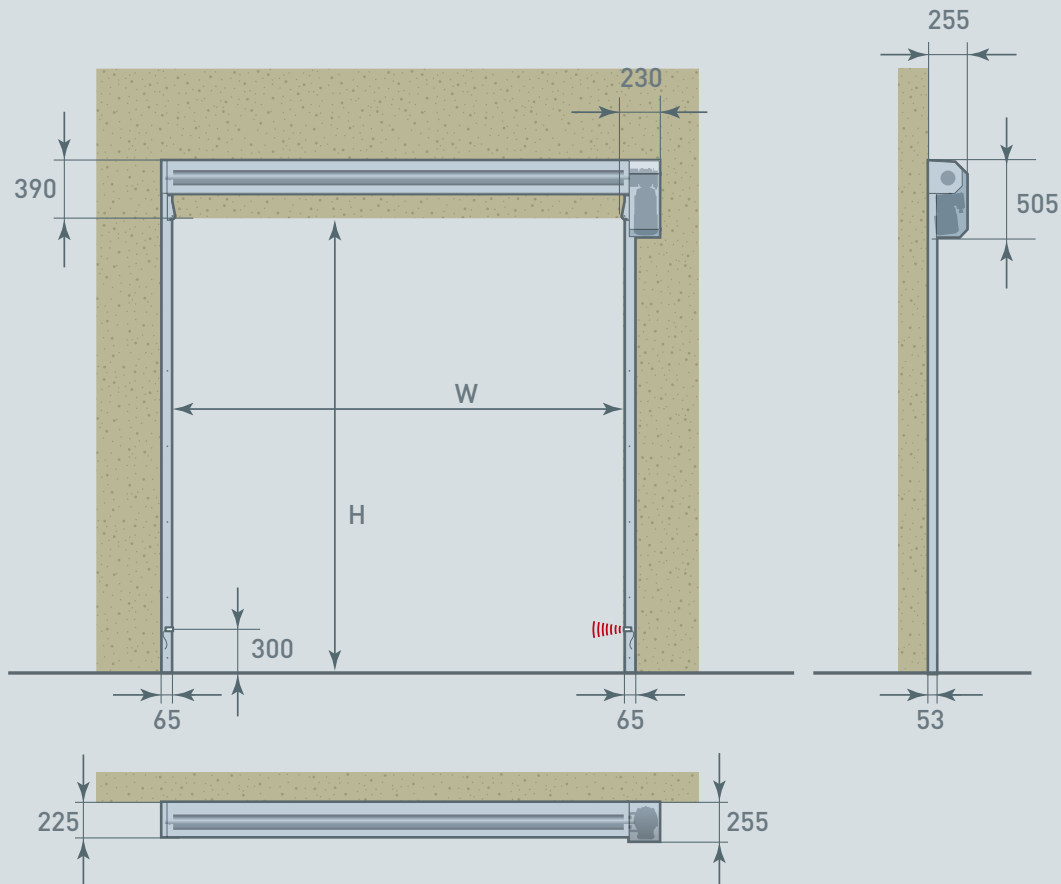

All indicated dimensions are based on exact width and height dimensions only. The space necessary for mounting and maintenance has to be provided.

REMARK: Based on the risk analysis of the environment, extra push buttons, detectors and covers might be required.



ENTREMATIc BELGIUM NV  
Waverstraat 21  
B-9310 Moorsel-Aalst (Belgium)  
Tel. +32 53 72 98 98  
Fax. +32 53 72 98 50  
info.dynaco.eu@entrematic.com  
www.dynacodoor.com

### About Dynaco

Founded in 1987, the Dynaco brand has a strong heritage and a wealth of expertise in high performance doors. Dynaco is committed to achieving excellence in quality and performance through a certified and dedicated network of partners, providing outstanding service to customers worldwide. Furthermore we trust our USA division and our licensed partners in Russia, Japan, China, Vietnam and Brazil to deliver on our customer promises. Dynaco is part of Entrematic—the home to some of the world's most innovative and leading brands within the entrance automation industry. The comprehensive range of product brands includes Ditec, Normstahl and em/Entrematic.