

# Whatever you have in mind.



your ideas – our solutions

## Coating Technology

**alco**<sup>®</sup>  
food-machines

11.11.2021



Welcome to the world of

**alco**

## Our company delivers **quality from conviction**

As a family business, it's our aspiration to go beyond expectations, advise every client individually, and develop the **best solutions** together.

Count on a partner you can trust, an employer who's there for you, a company that knows what it stands for.

## **Reliability, trust, connection**

alco is characterized by constant further **development, reliability, and flexibility** towards our clients and a connection to our roots.

Founded as a family business over 40 years ago, we've stayed true to ourselves to this day: Direct communication at eye level and the goal to extensively and optimally meet client requests, have made us what we are today: a **strong partner in the food processing industry**.

Our employees, clients, and end users notice that – thanks to us providing innovative solutions that are individually tailored to your needs!

# Machines that fit your business

It takes more than one step to make finished products. With our **convenience technology**, all processing steps required for forming to flattening, cutting, and coating to frying, cooking, pasteurization, fermentation, and cooling can be completed automatically.

1 forming

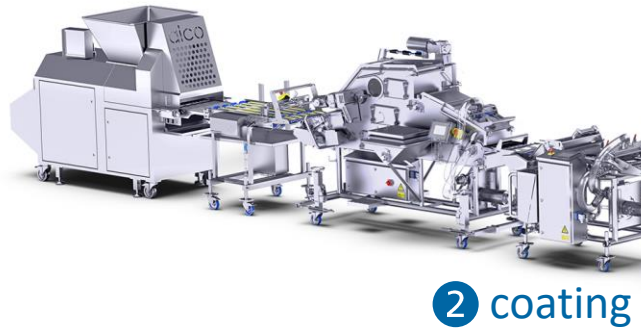

3 frying

4 cooking/roasting

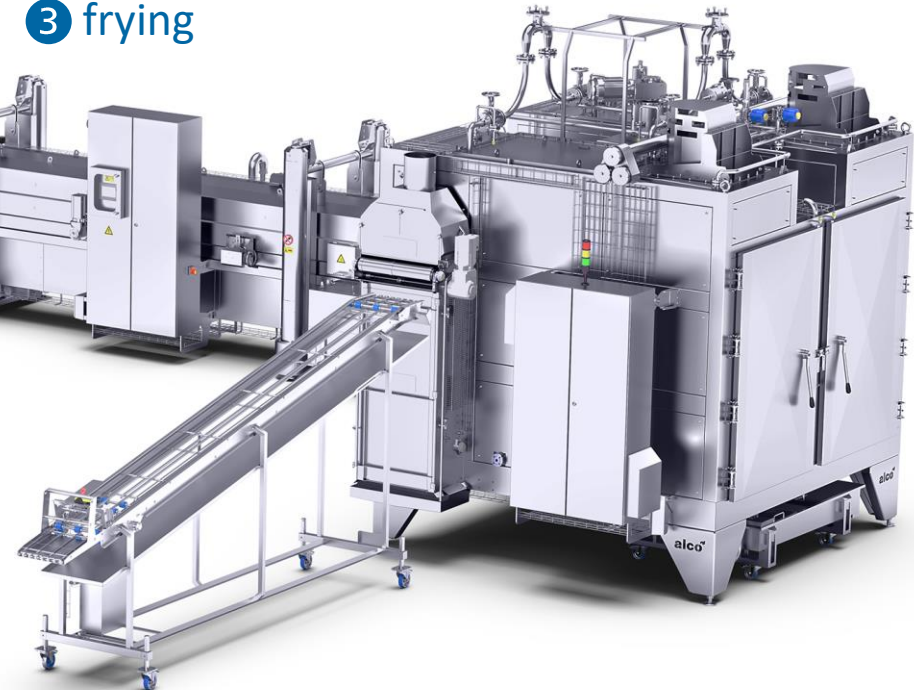

# Your idea is unique. So are our solutions.



## Meat processing

Good meat processing is a question of the right machine.

Whether juicy burger patties, crispy schnitzel, or stakes with grill-like flavor:

We'll help you out.



## Poultry processing

Poultry is as versatile as our processing machines.

We know how you can optimally process grilled chicken breast, chicken nuggets or crispy thighs.



## Vegetables processing

With vegetables, anything is imaginable. We make it possible.

Classic hash browns, Mediterranean stir-fried vegetables or floured onion rings:

Let us show you what we can do.



## Fish processing

We have the matching machine for your individual fish dish.

Cook fish filets especially tender, roast the batter to a crisp or apply specific grill patterns to the product surface.



## Plant-based food processing

Plant-based food is tasty in any shape, with lots of delicious flavor.

Vegetarian burgers, roasted vegetables or veggie gyros: plant-based substitutes can be processed with also easily and professionally.

# Your idea is unique. So are our solutions.



## Sauces & stews processing

We've got the machine for stews, sauces and ready meals.

**Our HotCook is a true all-rounder: Stews, sauces and ready meals are its specialty.**

**You'll be impressed.**



## Dough processing

Dough offers so many possibilities, and our machines do handle it.

**Crusty pizza, browned pretzels or lye sticks? Even when processing dough products, it pays using alco machines.**



## Milk & cheese processing

Cheesy or what? We can do cheese internationally.

**Camembert, mozzarella sticks or grated cheese: Our plants will guarantee qualitative processing of your products.**



## Sweets processing

Sugary and sweet is always a good choice: Sweets for every taste.

**Pies, wine gum and Berlin pastries are just some of the sweets that our food processing machines can handle.**



## Pet food processing

Believe us: even pets watch for good flavor and texture..

**Processing dog bones, wet food or chew sticks is made easy with the alco convenience technology.**

**Have a look yourself!**



# Preduster ABM

**Customized** in every detail

**Our systems are always a mirror image of your needs.**

Our coating machines are **completely designed, engineered, customized and built** by our specialists at alco's headquarter in Bad Iburg, Germany, and in close consultation with our customers, guaranteeing **performance above regular expectations.**

**Get an insight** into what makes an alco Preduster **special and popular** among many food processing companies around the world.

# Fine in taste

## Working principle

Optimal coating with minimal material input: fine media such as fine-grained flour, spices, powder and sugar can be applied evenly and precisely regulated to your product.

Our **preduster ABM** allows for ideal processing of fine coating media. Two belt systems guarantee a complete and uniform coating. A lower belt guides the product through a media bed and at the same time the upper belt generates the necessary sprinkling from above onto the product to be coated.

Via adjustable pressure, vibration and blow-off systems, your products thus receive exactly the coating you intended.

## Perfectly suitable for

Application of dry rubs to BBQ meats, floured fish filets, predusted convenience food, seafood, pastries and candy



# Perfect coating and optimum hold

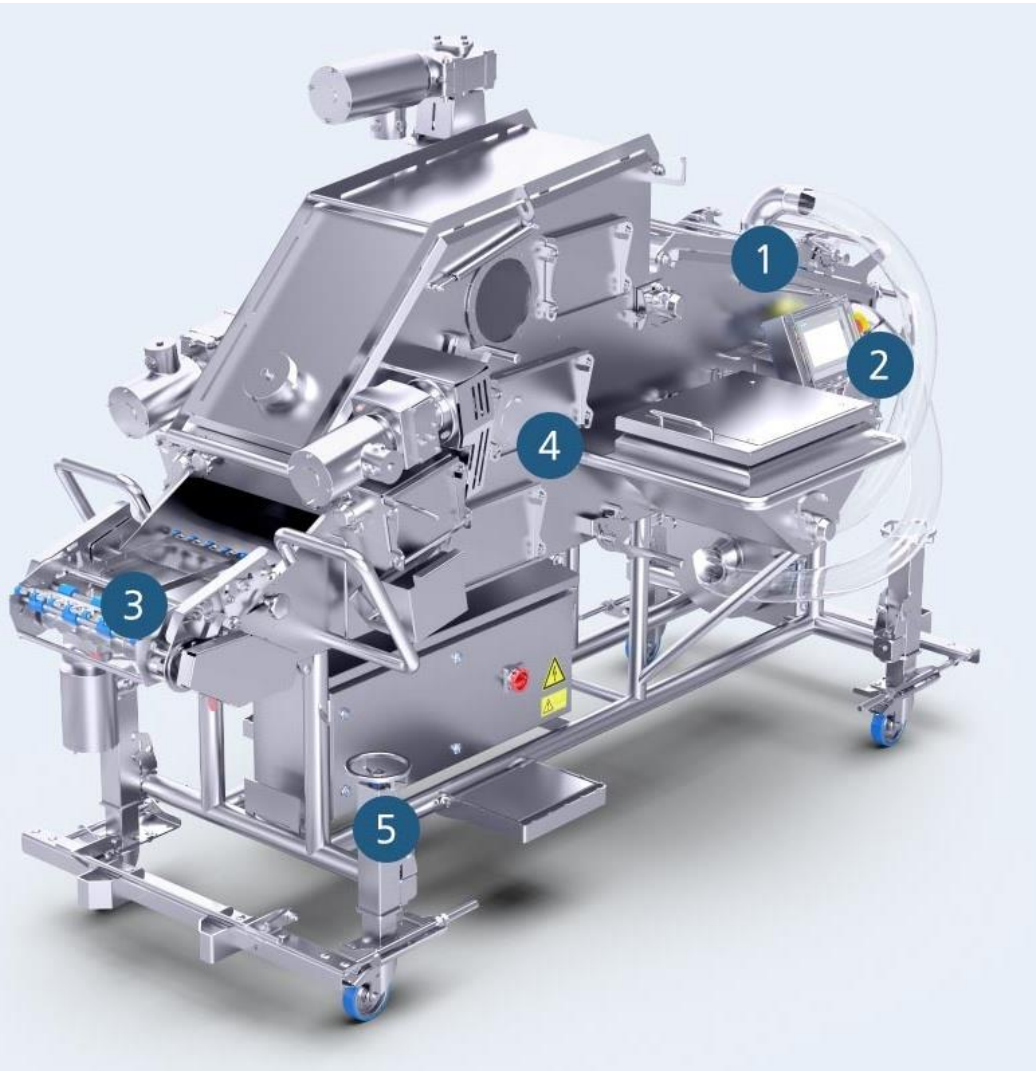

## Key Features

### 1: Air knife

removes excess material from the top of products via an adjustable blower system with additionally integrated return system.

### 2: PLC control

controls the plant in a smart and user-friendly way via a touch panel with functions like recipe management, etc.

## Optional

### 3: High-speed product belt

allows for belt speeds of up to 29 m/min via a top performance stainless steel drive.

### 4: Vibrating plate

used for coarse coating material to be pressed onto the product for optimal coating and to eliminate void spots.

### 5: Spindle height adjustment

sets the height of the entire machine by means of a handwheel.





# Easy to operate and to maintain

## Benefits

- Continuously adjustable production speed
- Particular suitability for all coating materials of fine grain
- Conveyor system with material return and minimal dust generation
- Adjustable amounts of coatings to be applied
- Adjustable vibration and pressing devices for achieving the optimal coating result
- Perfect product transfer through a pivotal outlet belt
- Made entirely of stainless steel and food-approved high-quality plastics
- Easy-to-clean design, easy to empty the material

**Watch YouTube-Video for more insights**

Preduster ABM

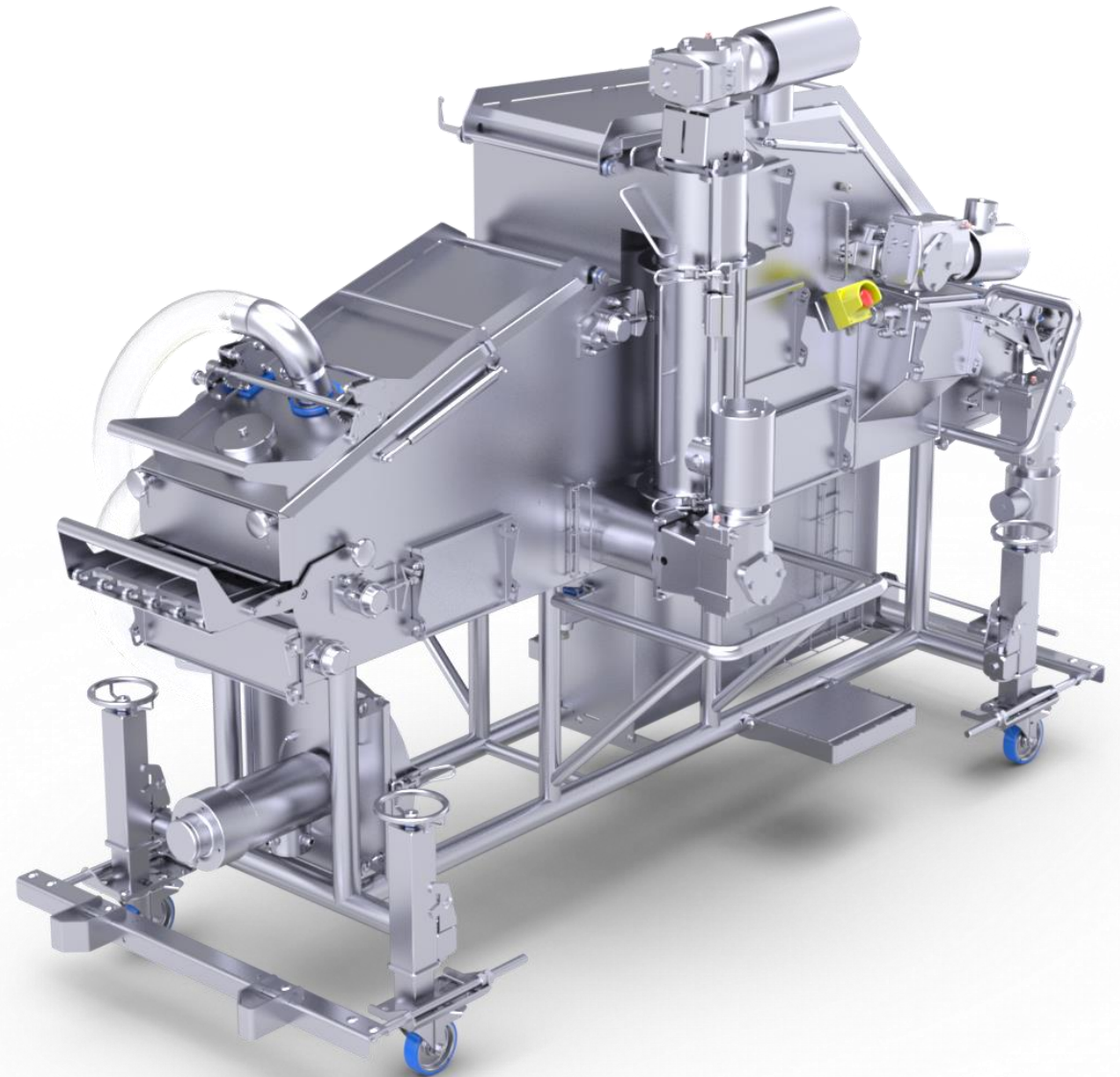

# Preduster ABM: Insights on processing



## Conveyor system

Continuously adjustable production speed with material return system and minimal dust generation already integrated in the standard version.



## Choose your product

Rely on the preduster ABM simply in any situation: whether fine flour, powder, spices or even sugar.



## Follow-up devices

For the realization of the optimal coating result, adjustable vibration and pressure devices can be added as well as dust sucking units.



## Individual adjustments

Adjustable application amount can be easily controlled by hand and without additional tools.

## Preduster ABM: Exemplary products



### Spices

Speaking of the BBQ season, the preduster ABM is exactly the right choice to pick. Spiced pork, turkey breast or others: it's up to you!



### Powder

Of course, coating with very fine powder should not be forgotten. Easy to apply and to process!

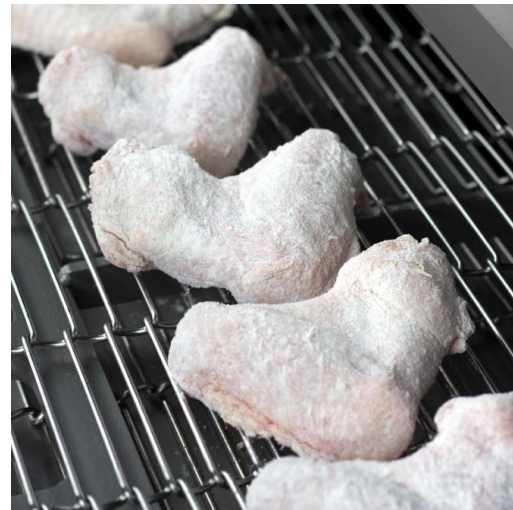

### Flour

Apply flour to your products previously to applying batter and your results will become a great deal better than before.



### Sugar

Cover your pastry or sweets with all kinds of sugars for the perfect taste, while producing on an industrial scale.

# Additional devices for a fully automated production process

## Flour Feeder APZ M

The alco flour feeder is suitable for almost all types of standard flours, spices or sugars, equipped with **high-quality stainless-steel drives** and is delivered including connecting elements for the pre-duster.

The coating material is gently fed by a feed screw into the upper hopper of the pre-duster. An additional horizontal feed screw, mounted at the bottom of the hopper, ensures a continuous and even transportation of the material.

## Dustfree Cyclone PRO

The alco dust extraction system Dustfree Cyclone PRO is used to continuously remove excessive dust from alco pre-dusters and **ensures an almost dust free working environment.**

It is creating subatmospheric pressure within the machine, which whirls up all the dust. In the next step, this dust gets sucked out and collected in a separate collection tank for reuse, **increasing yields and sustainability in your business.**

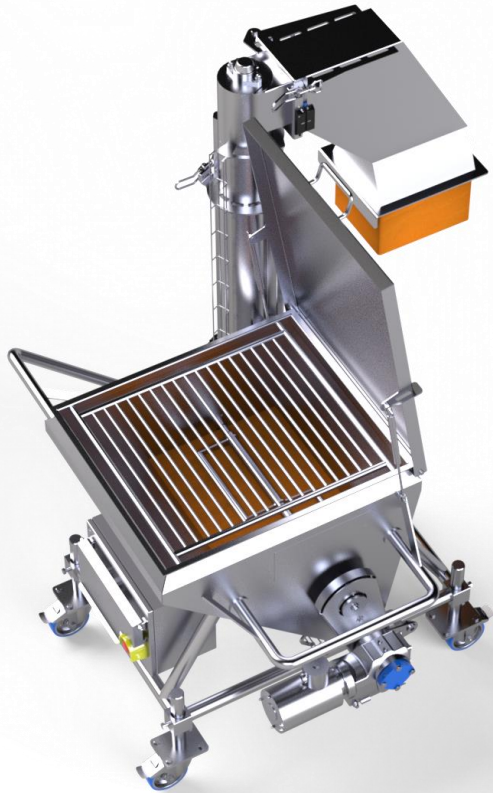

## Giving you the possibility to do more

Whether for smaller businesses or for large-scale production industry. Using the alco coating line, you'll get the appropriate application technology for your product. We'd also be happy to develop a completely individual solution for your product idea.

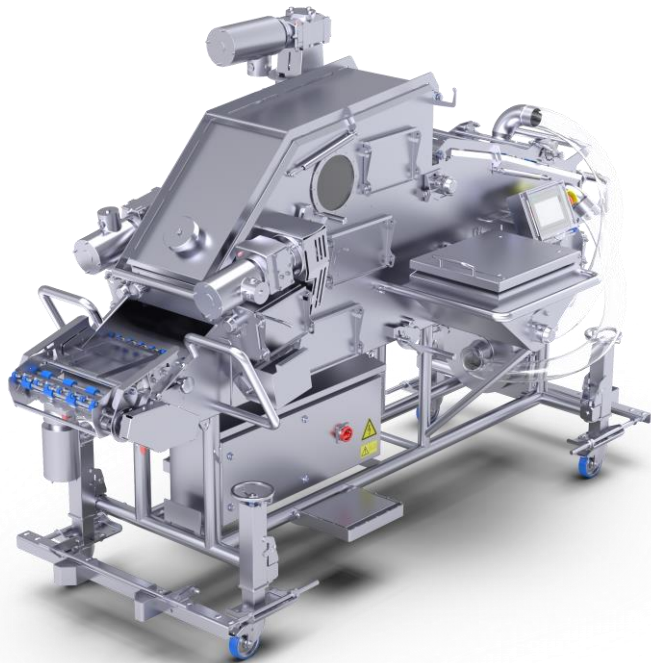

**Preduster  
ABM PRO**



**Battering machine  
APN PRO**



**Breeding machine  
APT PRO**

# Get in touch with our team

## Let's develop a solution together

Because we are in close contact with our customers, we do better understand their **individual requirements**.

As a family business we know how important direct and timely communication is.

In other words, you can always **speak to the person responsible** – including the management.



**No matter what your question is, we will help you**

**Alco-food-machines GmbH & Co. KG**

Kreienbrink 3 + 5  
49186 Bad Iburg  
Germany  
Phone: +49 (0) 5403 79 33 – 0  
Mail: [info@alco-food.com](mailto:info@alco-food.com)

[www.alco-food.com](http://www.alco-food.com)

24h service hotline:  
+49 (0) 151 – 51 42 90 20

# Follow us & get to know alco

## We're helping you out with all you need to know about alco

Whether it is social media, our magazine “appetizer” or our monthly newsletter – you’ll always stay up to date.

Follow us for the latest news on our machines, revealing behind-the-scenes stories, machine highlights and more interesting stuff!

Simply try and see!

Follow us on social media, watch our videos on YouTube, subscribe to our newsletter or download our appetizer: Just click on the icon – it’s that simple.

