

Recos[®]

Ulna Shortening and
Radius Reconstruction System



In the field of hand surgery we not only offer you solutions for standard restorations, but also products for unusual and difficult situations. We therefore regard ourselves as being a true highly specialized partner in all matters relating to hand surgery with our intelligent system solutions.

Recos®

Ulna Shortening and Radius Reconstruction System

Radial fractures are frequently followed by postoperative malalignment that can lead to loss of strength as well as pain. Moreover, the length ratio between the ulna and the radius might have been adversely affected by the intervention, although such dysbalance may also be a genetic condition.

Surgical radius reconstruction and ulna shortening can both be achieved by plate osteosynthesis.

With Recos®, we have succeeded in uniting these two corrective osteotomies in a single system. The plates are fixed using our proven smartDrive® screws. Only a handful of instruments are required for this application.

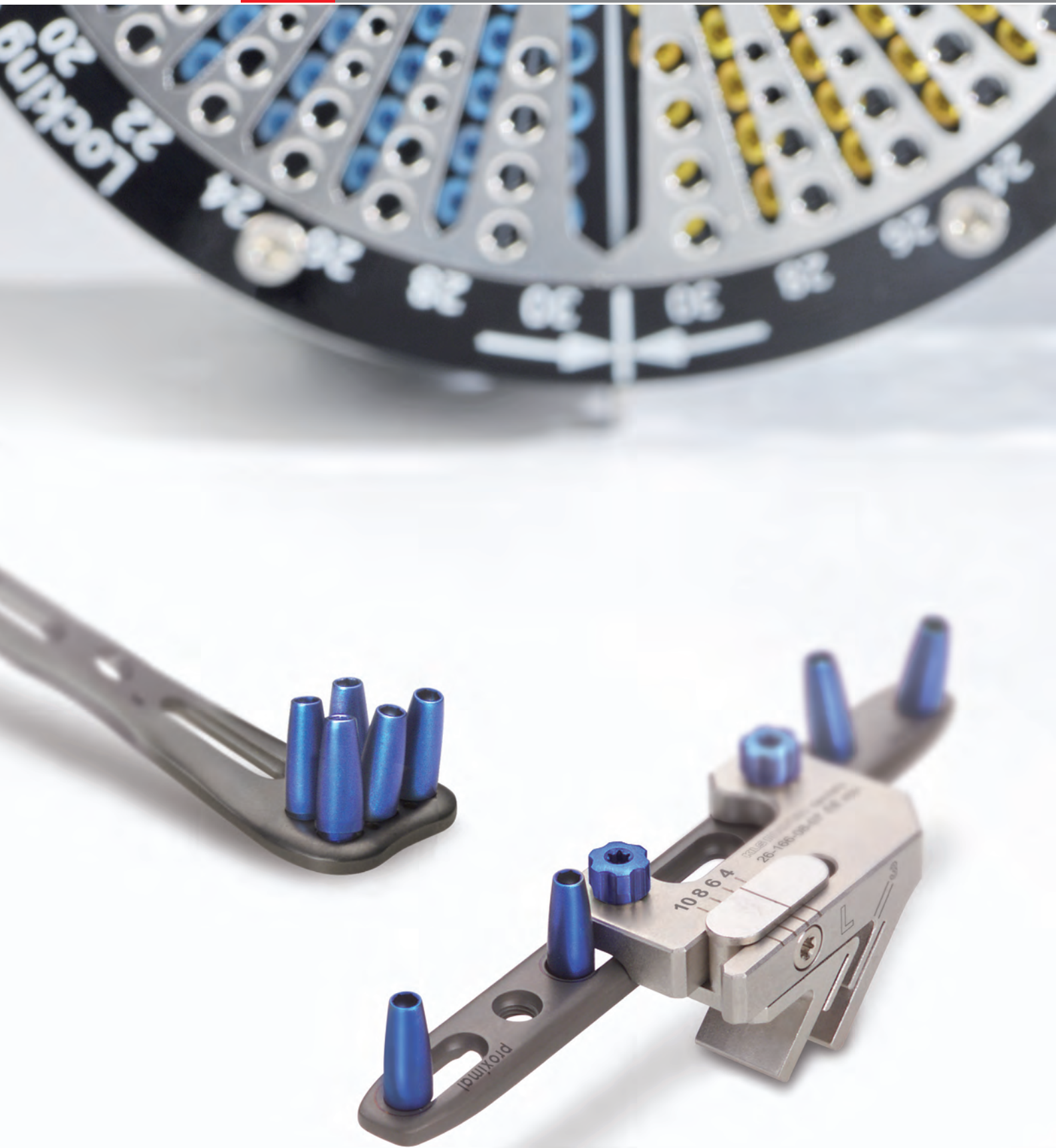

Table of contents

	Pages
Recos® – product features	6-9
Indications and surgical techniques	10-29
■ Ulna shortening	
Treatment with a palmar 7-hole plate	10-21
■ Radius reconstruction	
Treatment with a palmar watershed-line plate	22-29
The product range	
■ Recos® implants	30-35
■ Recos® instruments	36-41
■ Recos® storage system	42-43

Feature, Function and Benefit



The Recos® plates come in an anatomical design for best possible reconstruction results. For example, the distal holes of the radius reconstruction plate have been arranged so that, thanks to the high stability achieved by the plate, no bone chip is usually required any more. In the case of the ulna shortening plate, the combination of angled distal holes and elongated proximal holes allows you to anchor the system securely in the bone and achieve easy and rotation-stable closure of the osteotomy gap at the same time. All Recos® plates are finished with the Dotize® surface coating to achieve, among other things, maximum stability with a minimized plate geometry.

Our range of smartDrive® screws provides you with standard as well as locking screws featuring double threads to cut the screw-in time by half. Besides, all screws come with an atraumatic tip. The offer is rounded off by screws with a diameter of 2.5 mm and 3.0 mm, which are available in 1-mm increments across the crucial range of lengths.

All screws are color-coded for easy use:

Blue: locking smartDrive® screws

Golden: standard smartDrive® screws

Recos® implants

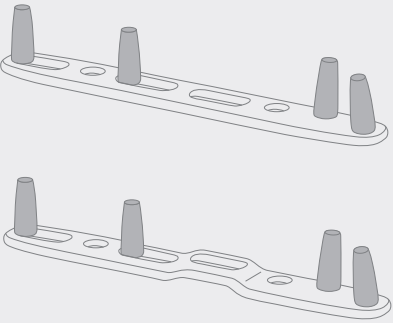
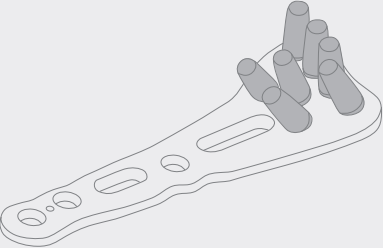
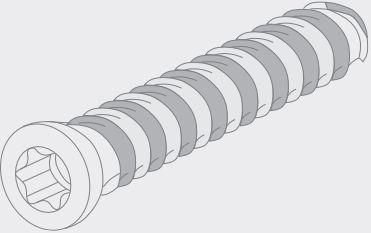
	Features	Benefits
<p>Recos® Ulna shortening plate</p> 	<ul style="list-style-type: none"> ■ Pre-angled distal screw holes ■ Two elongated holes for closing the osteotomy gap ■ Color-coded drill sleeves ■ Bridge plate with recess in the osteotomy zone 	<ul style="list-style-type: none"> ■ Best possible anchorage in the bone ■ Standardized, secure closure of osteotomy gaps up to 10 mm ■ Unambiguous use of the 2.0-mm smartDrive® core hole drill for smartDrive® screws Ø 2.5 mm ■ No contractions between saw blade and plate, safe transection of the periosteum
<p>Recos® Radius reconstruction plate</p> 	<ul style="list-style-type: none"> ■ Anatomical, atraumatic plate geometry ■ Plate design and screw hole angulation specially adapted to the needs of radial corrections ■ Watershed-line concept ■ Color-coded drill sleeves 	<ul style="list-style-type: none"> ■ Best possible embedding in soft tissue ■ Optimized distal reduction and support after the osteotomy thanks to ideal screw positioning ■ Enables extremely distal plate positioning ■ Unambiguous use of the 2.0-mm smartDrive® core hole drill for smartDrive® screws Ø 2.5 mm
<p>smartDrive® screws</p> 	<ul style="list-style-type: none"> ■ Atraumatic screw tip ■ Atraumatic screw head ■ Double thread, self-tapping ■ T8 with self-retaining function 	<ul style="list-style-type: none"> ■ Secure and soft tissue-friendly bicortical anchorage ■ Maximum range of angulation without causing any soft tissue irritation ■ Cuts screw-in time by 50% ■ Easy screw pick-up, screw-in, tightening or removal

Feature, Function and Benefit



The KLS Martin Group is committed to providing users with instruments that can be handled most easily and efficiently. Therefore, the reconstruction system comprises just a handful of instruments. No more is required because this instrumentation has been specially adapted to the specific needs of reconstruction.

In addition to easy handling, the requirements of sterile processing were given top priority in designing the storage system.

Recos® instruments and storage system

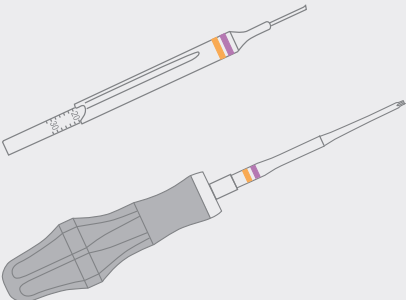
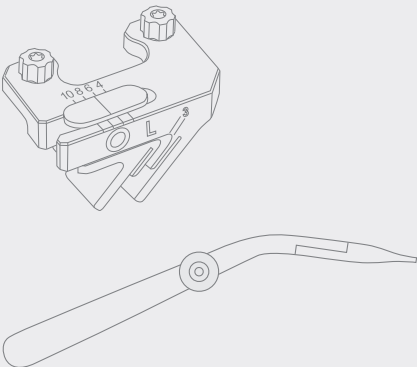
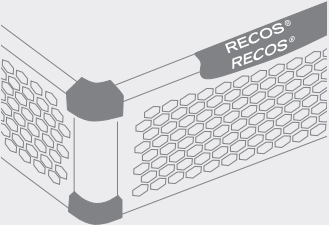
	Features	Benefits
Instruments 	<ul style="list-style-type: none">■ Color-coded instruments<ul style="list-style-type: none">■ smartDrive® Ø 2.5 mm (purple)■ smartDrive® Ø 3.0 mm (orange)■ Single-part instruments with ergonomically shaped silicone handles	<ul style="list-style-type: none">■ For easy identification of the respective instruments■ Good tactile feedback, no parts that could get lost, no play in the coupling
Instruments for ulna shortening 	<ul style="list-style-type: none">■ Plate can be fitted with side-specific saw guides that are infinitely adjustable across a range of 3–10 mm■ Angled compression forceps with diamond-coated pin	<ul style="list-style-type: none">■ Enables an exactly parallel osteotomy to prevent correction loss■ Facilitates closing the osteotomy gap and allows maintaining the compression during screw insertion
Storage 	<ul style="list-style-type: none">■ Stainless steel storage tray in honeycomb design combined with high-performance plastic■ The instruments are arranged in the sequence of use during the surgical procedure	<ul style="list-style-type: none">■ High stability, but low weight■ Good rinsing results due to large openings■ No water residues■ For easy and efficient instrumentation

Step by Step to optimal Fixation

Indications

Recos® implants are used for correcting posttraumatic or genetic malalignment and/or differences in length of the radius or ulna.



Ulna shortening

- Ulnar impaction syndrome



Radius reconstruction

- Palmar corrective osteotomy following malunited radial fracture



Surgical Techniques

Ulna shortening

Treatment with palmar 7-hole plate
Prof. Krimmer, Dr. Leixnering

Pages 12-21

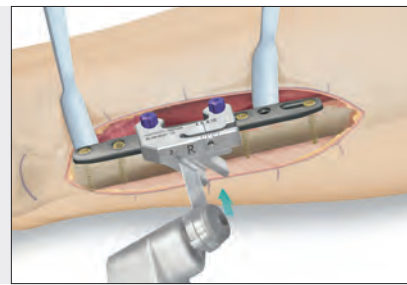

Radius reconstruction

Treatment with a palmar watershed-line plate

Pages 22-29

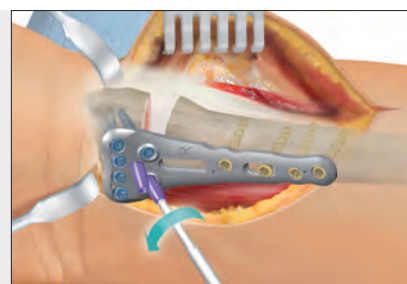

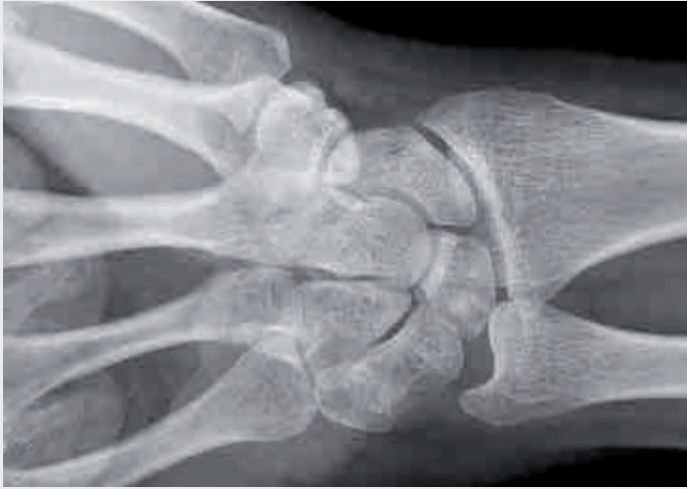

Preoperative planning

The ulnar impaction syndrome should be assessed using standard X-rays taken in the A/P and lateral planes, with the wrist in neutral position. It is recommended to take an additional X-ray under load with the fist closed against resistance.

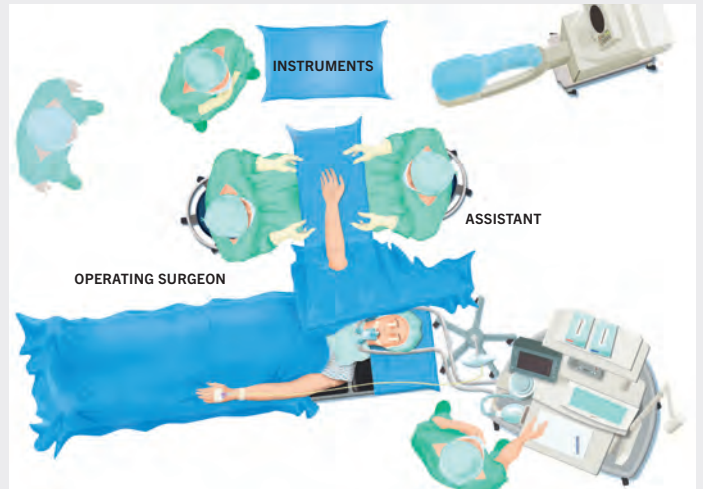

Patient positioning

The patient is placed on the back. The hand that requires surgery is placed on the extension table in full supination position of the forearm and under tourniquet control.

Alternately, before the operation commences the X-ray image converter can be covered with sterile drapes and positioned opposite the operating surgeon so it no longer has to be repositioned between the surgical steps. Once the exact setting has been selected it is thus maintained and reduces the radiation dose for the patient and operating surgeon. For certain indications the use of a horizontal hand extension device can be helpful.

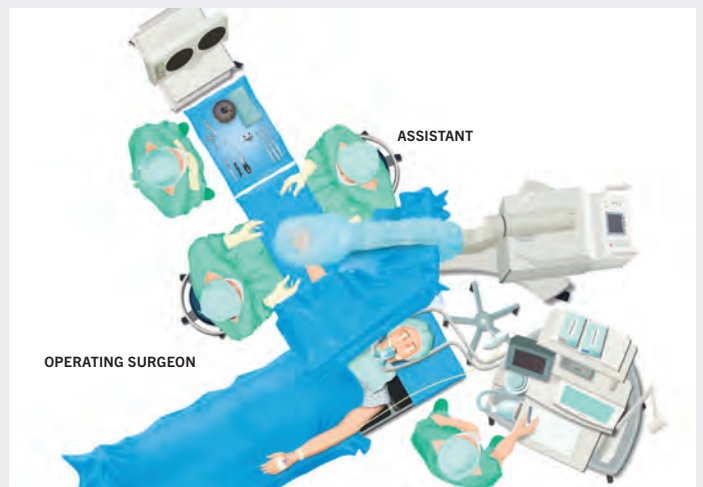

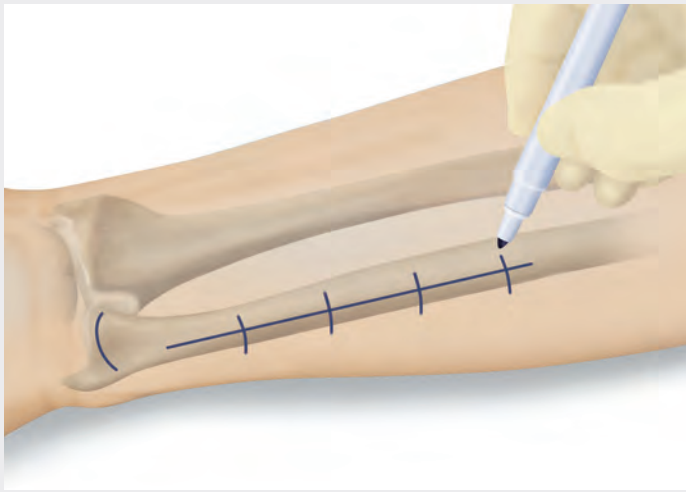

1. Ulnopalmar approach

A skin incision with a length of approx. 9-11 cm is made along the distal ulna. The ulnopalmar approach provides for secure postoperative soft tissue coverage of the plate.

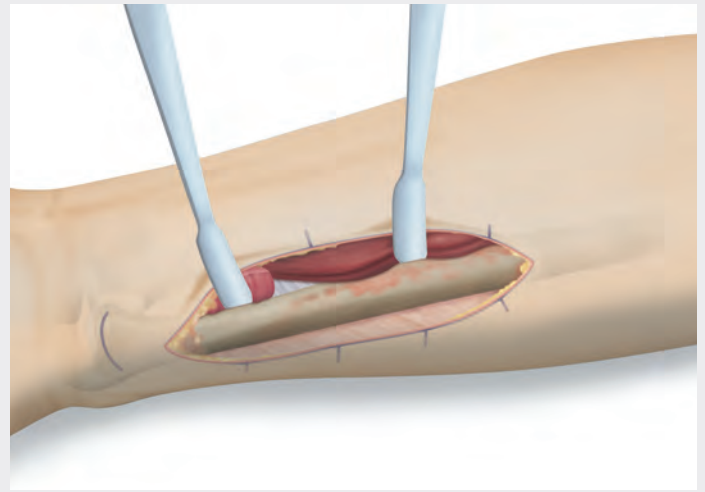

2. Exposure of the ulna

The incision is continued between the flexor and extensor muscles through the intermuscular septum. This is followed by exposure of the ulna, with the quadratus pronator muscle being carefully pushed off the ulna on the distal side.

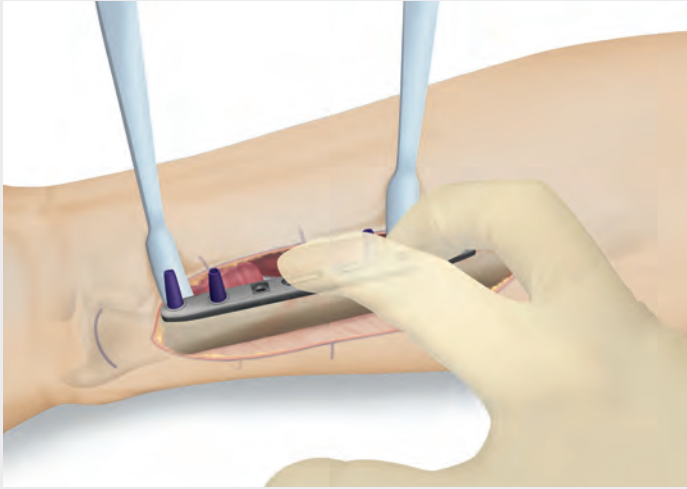

3. Positioning the plate

The plate is placed as far distally as possible, just below the ulnar head, at the inner edge of the ulna on the palmar side of the available surface. The plate is lettered (distal/proximal) for secure fixation.

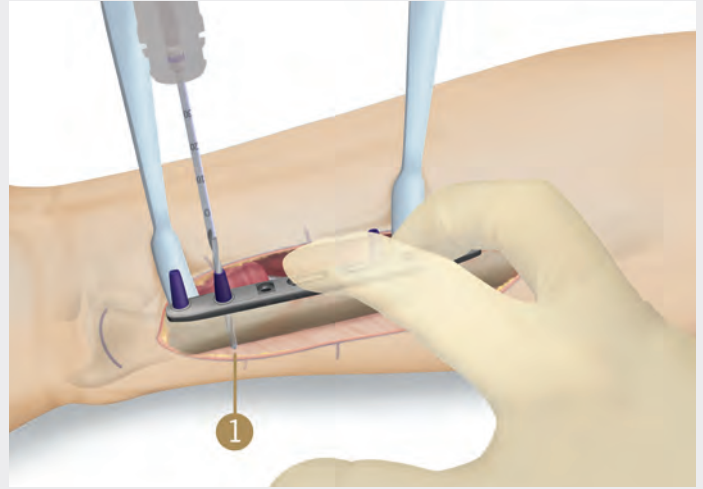

4. Drilling holes

The first core hole (\varnothing 2.0 mm) is drilled for a smartDrive® standard screw \varnothing 2.5 mm as illustrated (1). To ensure safe and easy drilling, the screw holes to be filled initially are already provided with drill sleeves that match the screw diameter of 2.5 mm (purple).



Core hole drill
AO fitting
 \varnothing 2.0 mm

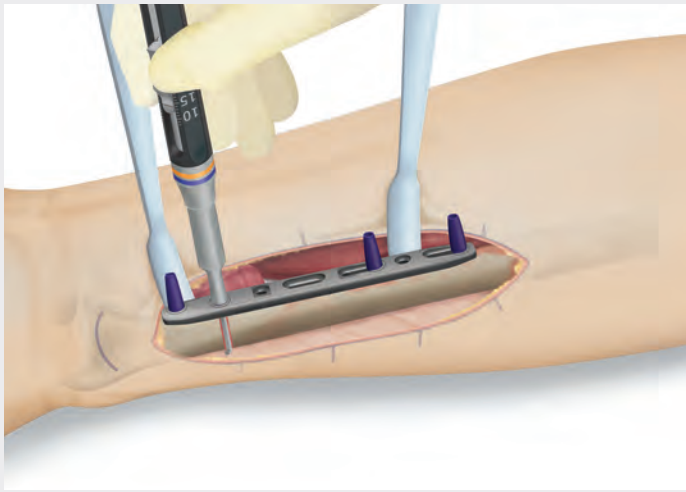

5. Determining screw length

Prior to determining the length of the screw, the premounted drill sleeves must be removed using the screwdriver.

The correct screw length is determined with the depth gauge. This is done with the plate applied to the bone.

Note:

Depending on individual preference, users can choose between the classic and the single-hand depth gauge.

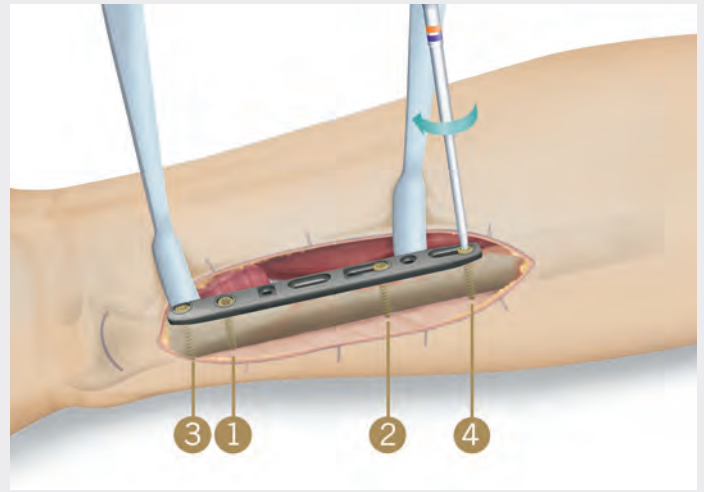

6. Inserting the screws

To fix the plate to the bone, the first four holes are filled with 2.5-mm smartDrive® standard screws of the measured length.

We recommend inserting the screws in the sequence shown above.

Note:

If bone quality is inferior, 3.0 mm dia. smartDrive® screws can also be used. In such a case, use one of the 3.0 drill guides, or alternately the sterile-packed screw-on 3.0 drill sleeves.



Depth gauge
single-hand
principle



Depth gauge
AO principle



T8 screwdriver



T8 screwdriver

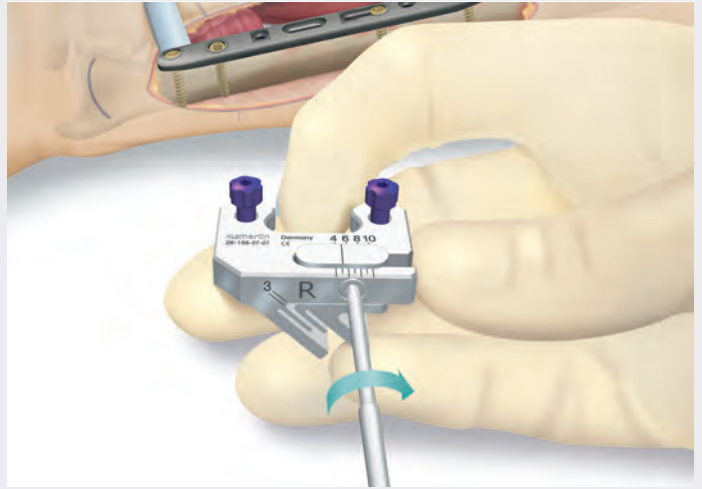
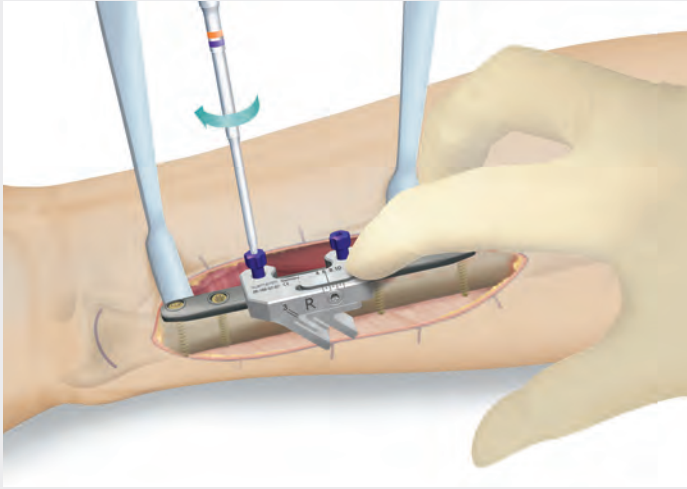

7a. Mounting the saw guide

The side-specific saw guide is mounted according to the marking provided on the plate, using the third distal hole and the distal end of the central elongated hole. To facilitate the process, the screwdriver can be used.

Note:

First, the distal screw is lightly driven into the circular hole but not tightened. As a result, the proximal screw can find its way in the elongated hole more easily. As soon as the two screws have gripped, first the proximal screw and then the distal screw can be finally tightened.

7b. Mounting the saw guide

The desired shortening can be set continuously on the saw guide in advance using the screwdriver. The set value is exactly identical with the actual shortening to be achieved.



T8 screwdriver



Saw guides



T8 screwdriver



Saw guides

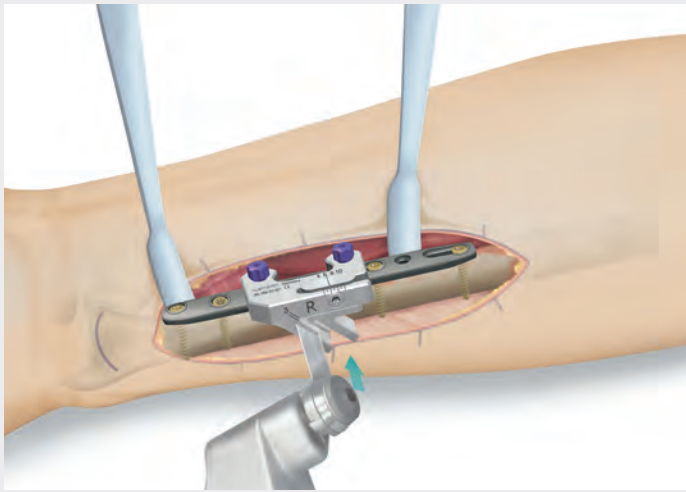

8. Osteotomy

The saw guide ensures a parallel osteotomy directly below the distal elongated hole.

To ensure a safe and precise osteotomy as defined, the sawblade must have the following dimensions:

- Cutting width (thickness): max. 0.65 mm
- Width of working blade: 15 mm
- Length: 35 - 40 mm

It is recommended to cut through the bone but leaving the palmar-side cortical bone directly underneath the plate intact for the time being.

Note:

To achieve best results, a powerful motor system and a new sawblade should always be used.

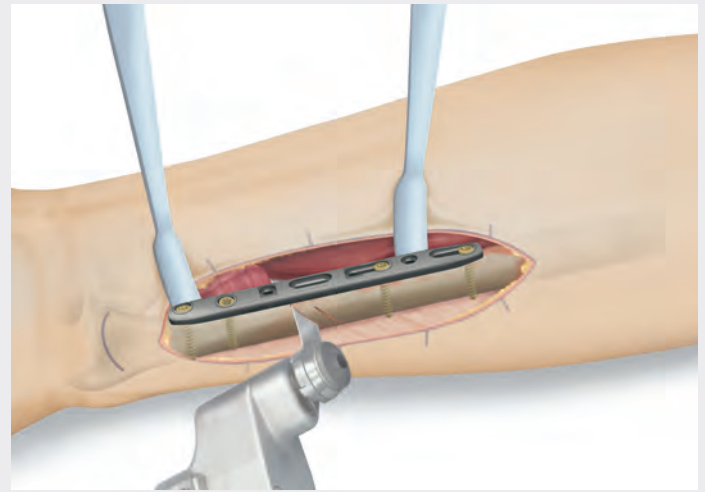

9. Final osteotomy

The final osteotomy is performed under visual control after removing the saw guide.

To perform the osteotomy without contractions between the saw blade and the mounted plate and to safely transect the periosteum, the Recos® bridge plate (26-166-75-09) can be used, which has a recess in the osteotomy zone.

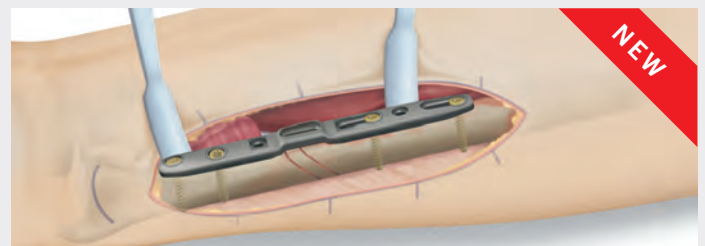

Saw guides

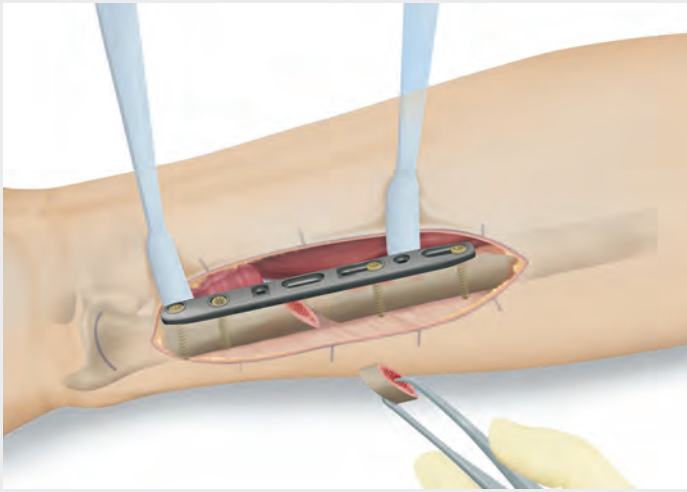

10. Removing the bone chip

The corticocancellous bone chip can now be removed with a pair of forceps.

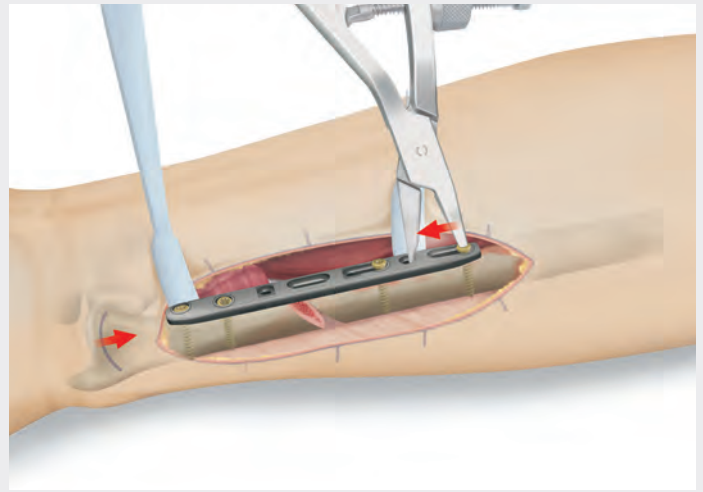

11a. Closing the osteotomy

To close the osteotomy gap, the two proximal standard screws are loosened by half a turn and the compression forceps are then applied.

Compression forceps are available in two versions left and right. This prevents collision with the screwdriver when tightening the screws.

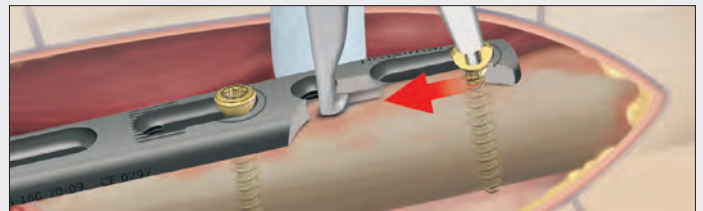

When applying the forceps, the hook engages with the groove of the proximal elongated hole while the diamond-coated pin engages with the head of the screw inserted into the proximal gliding hole.



Compression forceps

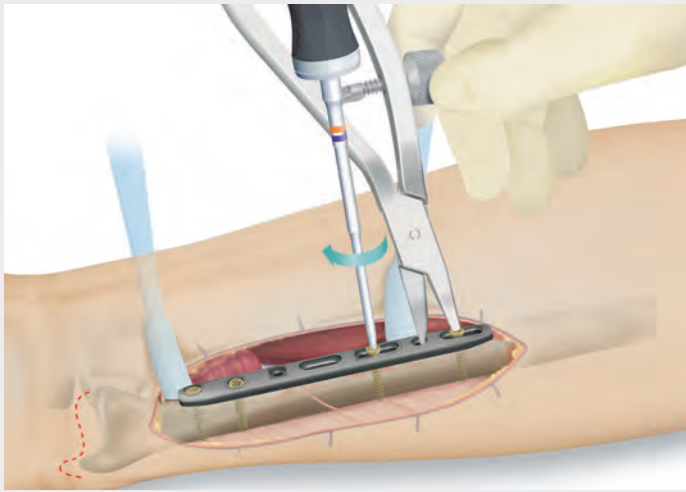

11b. Closing the osteotomy

Once the osteotomy gap has been closed with the compression forceps, the final position is fixed with the knurled screw.

Now the standard screw in the second proximal elongated hole can be securely tightened while leaving the compression forceps in place (see illustration).

If the lag screw technique (see 12) is used to compress the osteotomy gap, the standard screw in the second proximal elongated hole is tightened just a little.

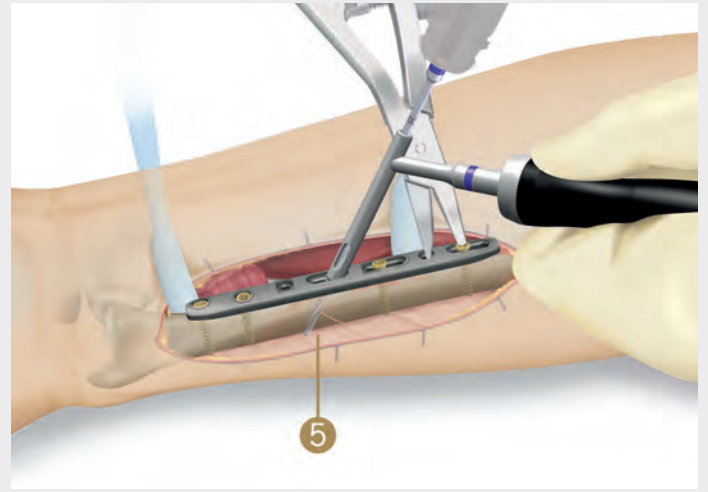

12a. Implantation of a lag screw

The distal elongated hole (5) can be filled with a lag screw.

This requires a hole to be drilled orthogonally to the osteotomy gap using the 2.0-mm smartDrive® core hole drill.

The smartDrive® gliding hole drill Ø 2.5 mm is then used to drill all the way to the osteotomy line.



Compression forceps



T8 screwdriver



Core hole drill
AO fitting
Ø 2.0 mm



Gliding hole drill
AO fitting
Ø 2.5 mm



Compression forceps

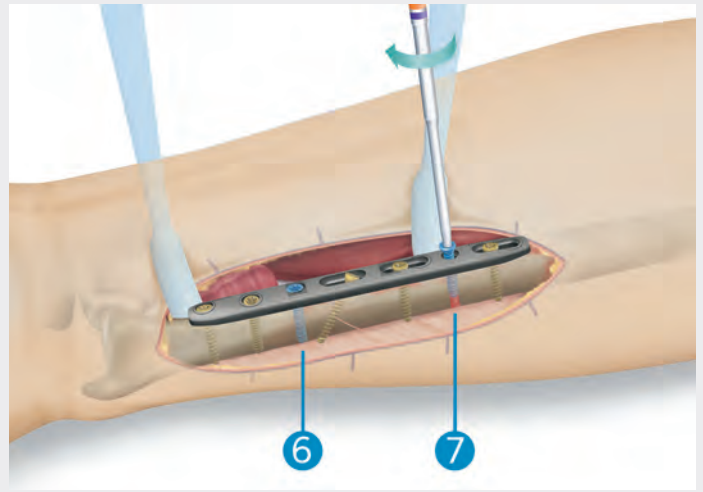
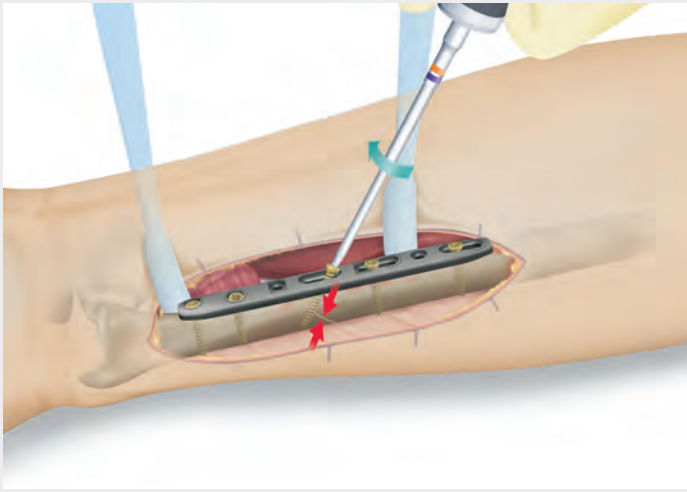

12b. Implantation of a lag screw

A 2.5-mm smartDrive® standard screw can now be implanted as a lag screw.

Immediately afterwards, the screws of the proximal elongated holes are tightened.

Note:

Screw tightening is done from inside to outside, starting with the one closest to the osteotomy.

13. Final fixation

To ensure multidirectional stabilization, the two remaining holes (6, 7) are now filled with standard or locking smartDrive® screws. Locking screws are usually used (see illustration).



T8 screwdriver



T8 screwdriver

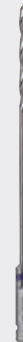

Core hole drill
AO fitting
Ø 2.0 mm

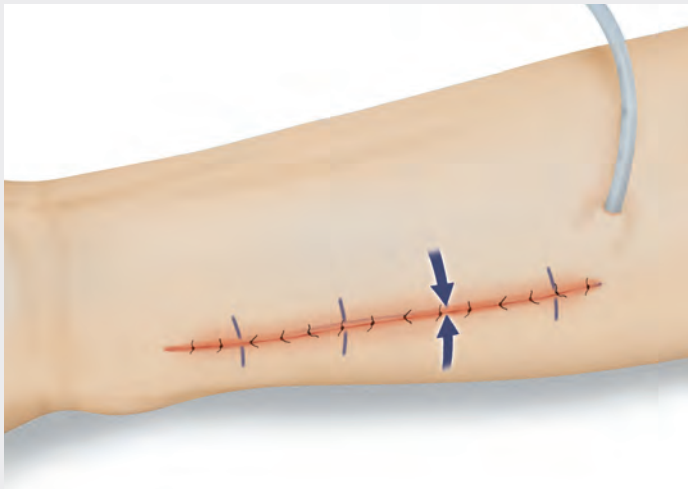

14. Closing the wound

Following wound irrigation and cleaning, the capsular and ligamentous structures are carefully restored.

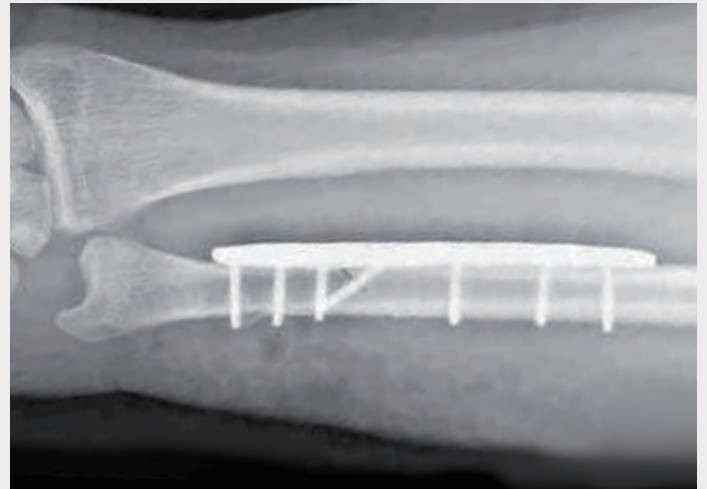

Postoperative treatment

Following skin closure, a final X-ray is taken.

After that a sterile dressing and a dorsal forearm splint can be applied for 4 weeks.

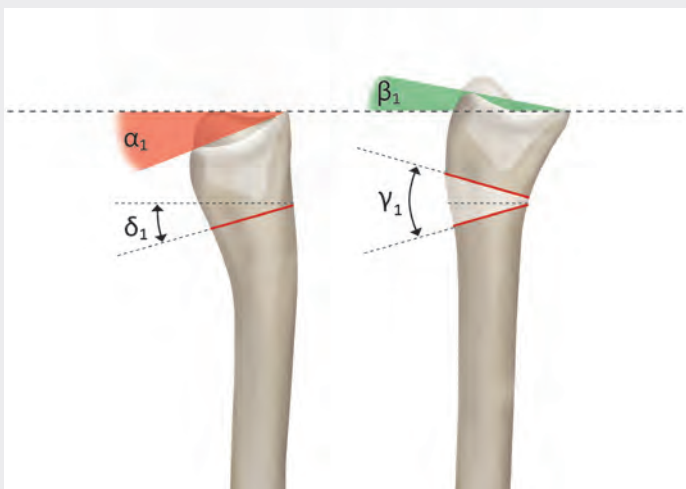
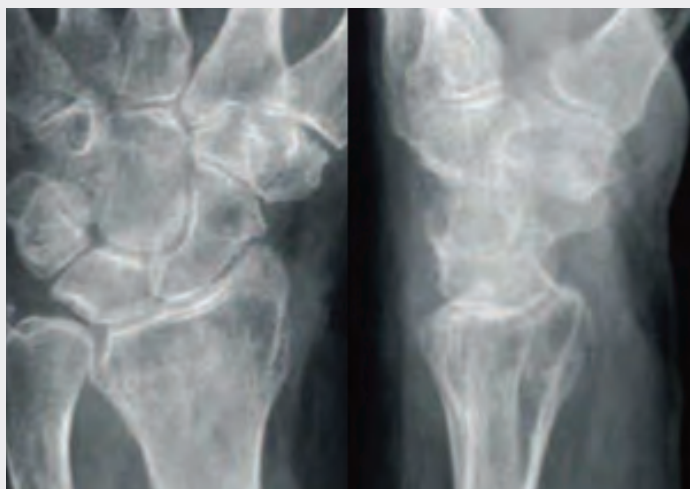

1. Preoperative planning for correction osteotomy

Healed distal radius fracture with posterior displacement

Radiographic example of distal fracture of the radius with shortening and posterior displacement. Note the clearly evident erosion of the lunate resulting from the traumatic ulnar impaction syndrome.

2. Correction of the posterior displacement

Dorsopalmar angle		
Present situation:	α_1	-22°
Objective:	β_1	10°
→ angle of correction:	γ_1	32°
→ angle bisector:	δ_1	16°

To determine the desired position of the joint take the posterior displacement of the radial joint surface from the lateral radiograph and compare it with its palmar inclination on the healthy side. The angle of correction (here: 32°) is the sum of the posterior displacement and the desired palmar inclination. It is best if the planned osteotomy angle (here: 16°) corresponds with the bisector of the correction angle. If possible, the osteotomy should follow the course of the original fracture line.

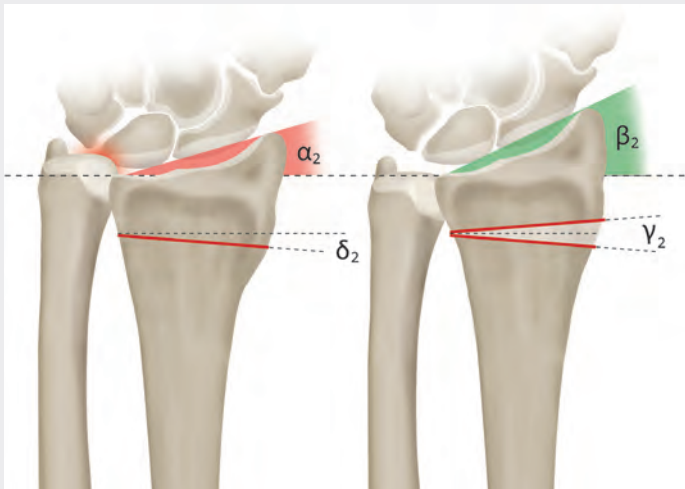

3. Correcting the ulnar inclination

Ulnar inclination

Present situation:	α_2	16°
Objective:	β_2	25°
→ angle of correction:	γ_2	9°
→ angle bisector:	δ_2	4.5°

Take the desired ulnar inclination from the contralateral AP radiograph.

The angle of correction is the difference between the desired ulnar inclination and the flattened ulnar inclination on the injured side.

Here, too, the planned osteotomy angle best corresponds with the bisector of the correction angle.

In case of a bone graft its ulnar height is given by the ulnar variance (distance AB).

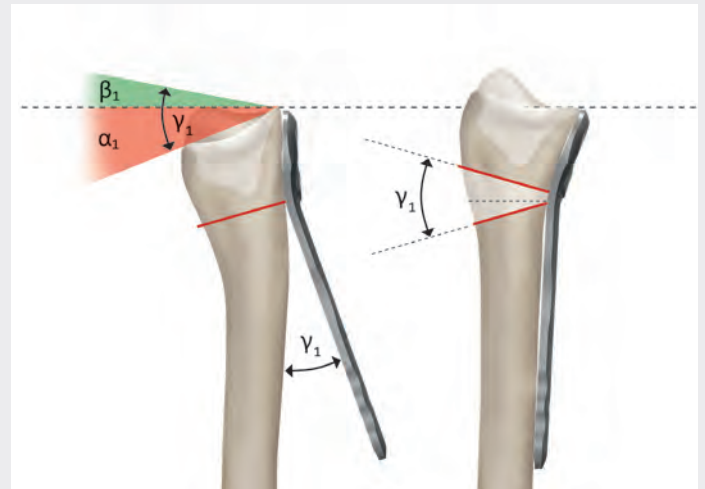

4. Implementing the planning

After distal fixation press the proximal shaft of the plate against the radius, thereby reducing the osteotomy.

Originally, the angle between the proximal shaft of the plate and the radial shaft is identical with the angle of displacement. Once the osteotomy opens to the desired joint position, the shaft of the plate will fully contact the radial shaft.

At the same time correct the ulnar inclination by aligning the shaft of the plate with the radial shaft. Under fluoroscopy check the correct adjustment of the radial length.

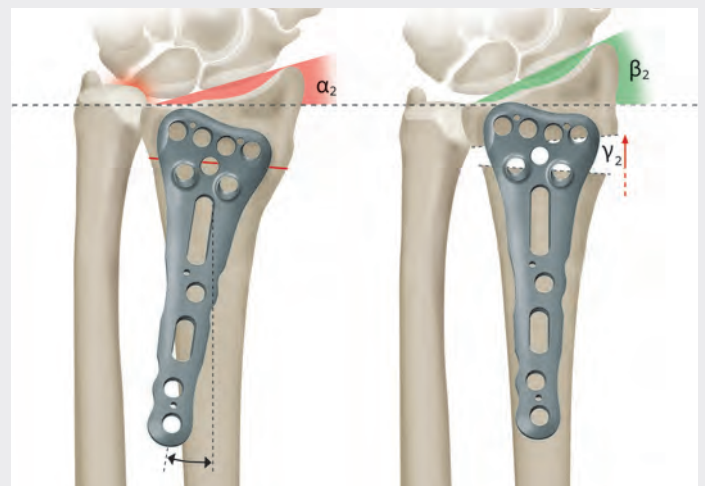
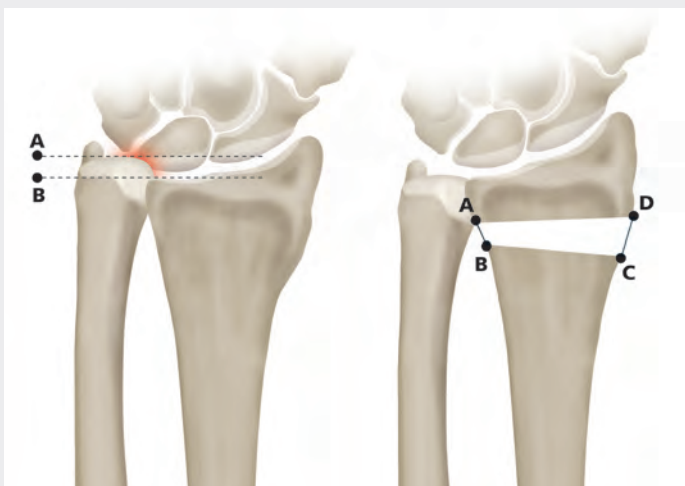

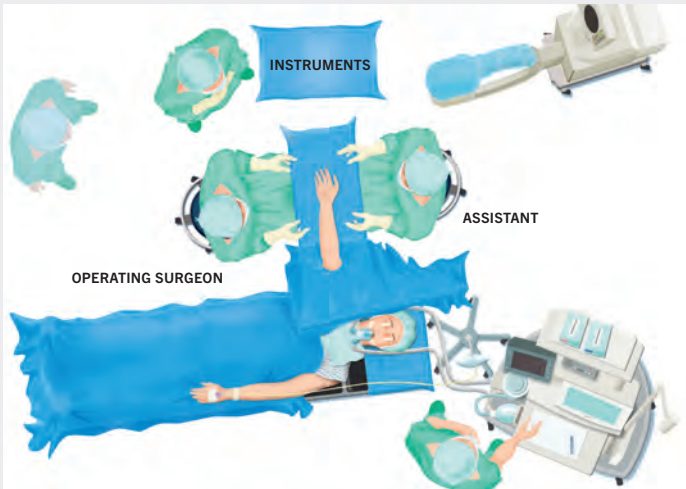

5. Positioning the patient

The patient is positioned supine on the operating table. Position the hand to be operated on on the extension table with the lower arm supine and apply a pneumatic tourniquet to the upper arm for arterial occlusion of the upper limb.

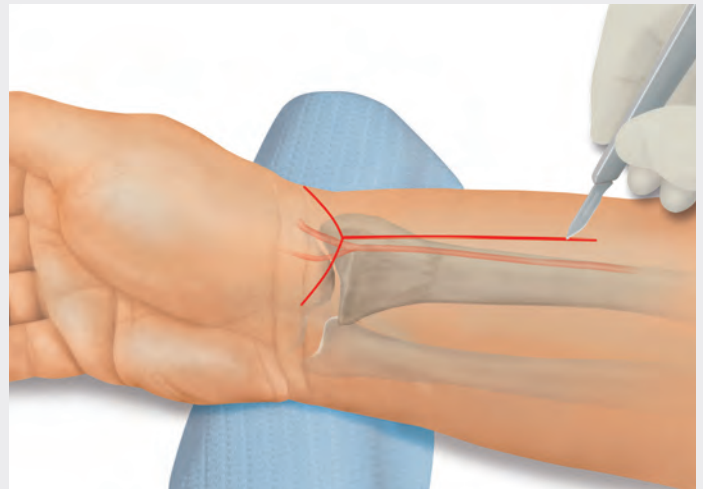

6. Radiopalmar access

Make a Y-shaped skin incision of about 7 cm over the distal radius. While its longitudinal axis should be over the radial artery, its ulnar branch should just reach the rasceta, with the radial branch reaching the second extensor tendon compartment.

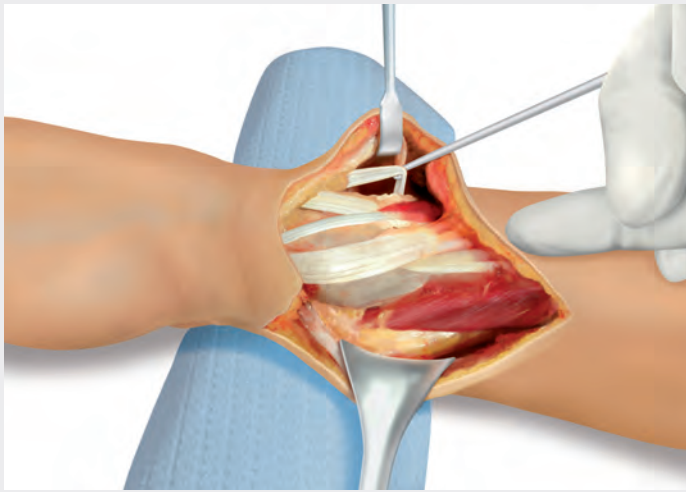

7. Dissection

Carry the dissection dorsal to the third extensor tendon compartment. Leave the branches of the superficial ramus of the radial nerve within the subcutaneous tissue.

Split open the first extensor tendon compartment and any subcompartments – if present – and partially or completely free the brachioradial tendon. Also open the second and third extensor tendon compartment.

After opening the third extensor tendon compartment elevate the extensor pollicis longus tendon.

Dissect the radial artery and its concomitant veins such that they can be retracted ulnad. Bluntly dissect the flexor carpi radialis, flexor pollicis longus and any other muscles off the pronator quadratus, and with Langenbeck retractors retract them ulnad together with the radial artery. This frees up the pronator quadratus muscle.

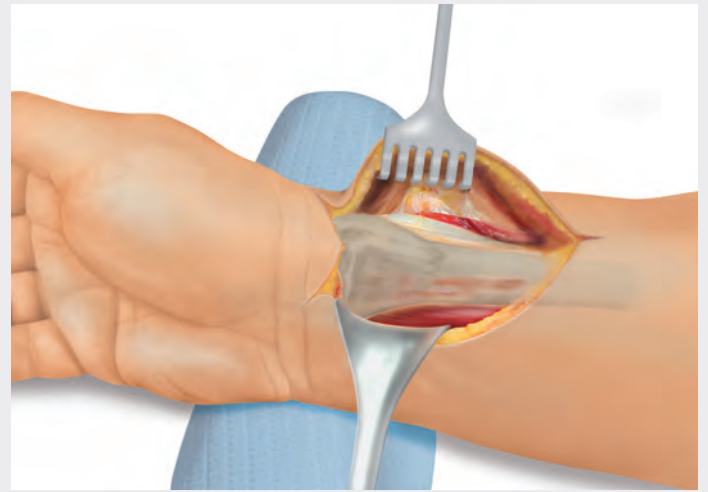

8. Exposing the radius

Once the distal palmar radius has been exposed, bluntly dissect the pronator quadratus muscle ulnad off the radius.

Incise the pronator quadratus at its radial margin and bluntly dissect it off the distal radius.

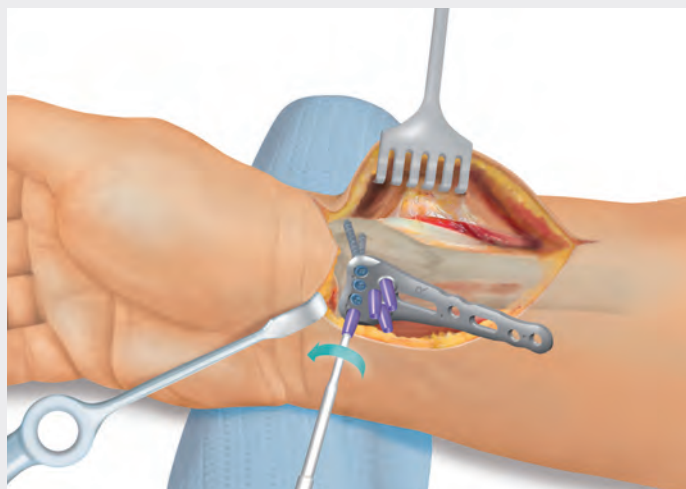
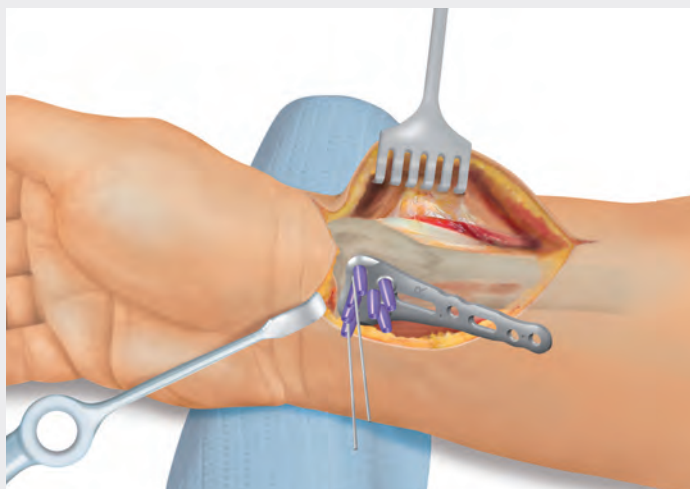

9. Positioning the plate

Position the plate distad of the planned osteotomy and once aligned fixate it with temporary Kirschner wires through the distal holes. Align the plate according to the preoperative planning. The shaft of the plate will not contact the radius. Check the plate position by fluoroscopy.

The temporary fixation with Kirschner wires allows easy correction of the plate position whenever needed.

First fixate the distal row of plate holes with screws (see fig. 10).

10. Distal plate fixation

Drill the first core holes (Ø 2.0 mm) for the fixed-angle smartDrive® screws (Ø 2.5 mm) and measure the screw length. For safe drilling and keeping the initial alignment drill the distal holes with drill guides matching the 2.5 mm screw diameter (violet).

Check with fluoroscopy.

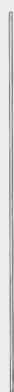

Recos® K-wire,
Ø 1.2 mm, 120 mm



Core hole drill
AO fitting
Ø 2.0 mm



Depth gauge
single-hand
principle



Depth gauge
AO principle



Screwdriver T8

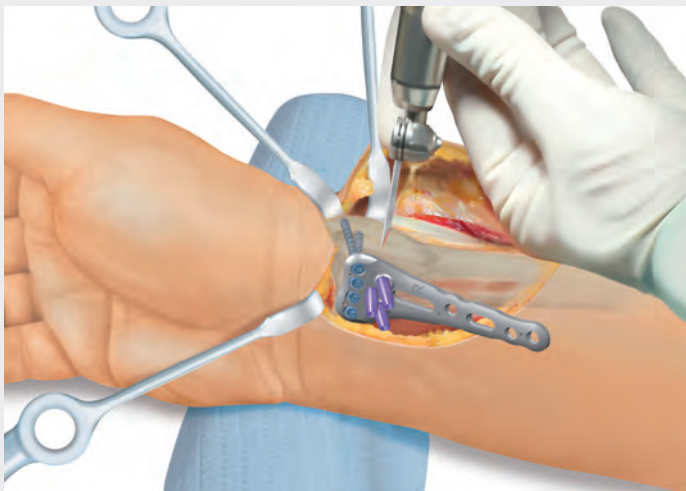

11. Performing the osteotomy

After inserting all screws in the first distal row mark the site of the planned osteotomy. It should be as close to the original fracture as possible, but at most at the level of the second distal row of screws.

It is best to perform the osteotomy with the oscillating saw in both planes along the bisector of the planned angle of correction.

In most cases it is possible to osteotomize with the distal plate in contact with and fixated to the bone. Otherwise remove the plate for the osteotomy or loosen the distal screws so that the plate can be sufficiently elevated off the radius. By using the present distal screw holes when refixating the plate, this will avoid any loss of correction.

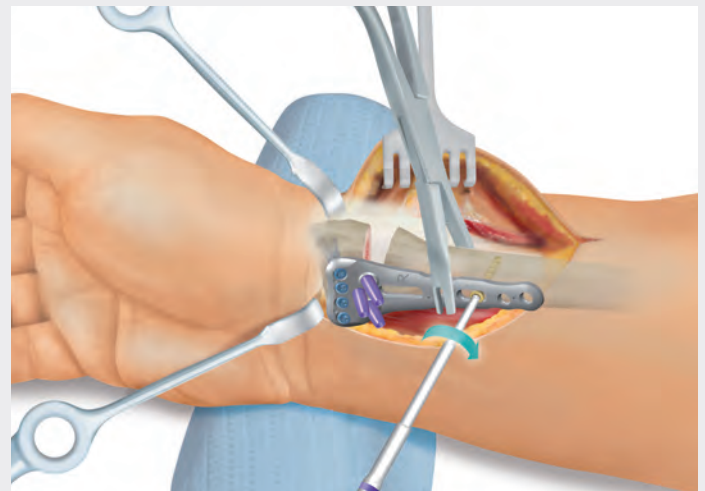

12. Repositioning the plate shaft and setting the radial length

Open the osteotomy gap with a distractor as in pseudarthrosis, position the shaft of the plate in contact with the radial shaft and temporarily secure it to the latter with two plate holding forceps. Now set the length of the radius.

After correctly positioning the plate along the long axis insert and lightly tighten a standard smartDrive® screw in the proximal slotted hole. The screw should be centered in the slotted hole. This allows for fine tuning the radial length.



Core hole drill
AO fitting
Ø 2.0 mm



Depth gauge
single-hand
principle



Depth gauge
AO principle



T8 screwdriver

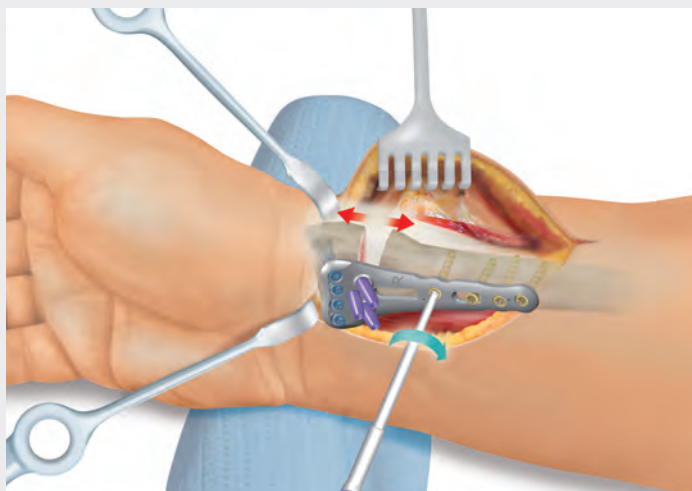

13. Fixating the plate on the radial shaft

Once the correction has been completed fixate the plate to the radial shaft with standard smartDrive® screws.

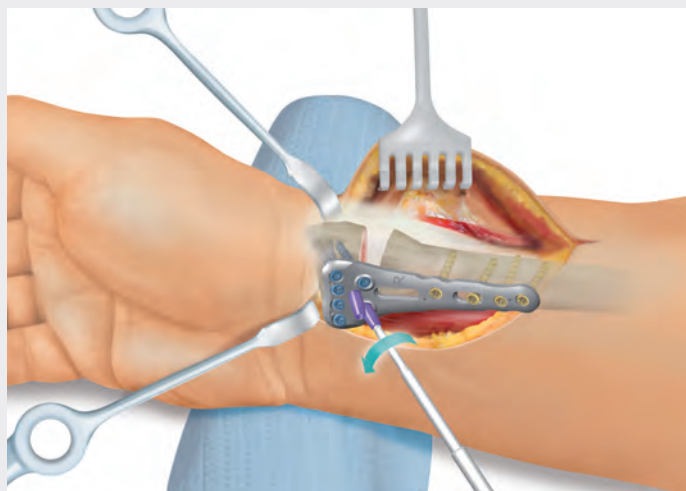

14. Inserting the second row of screws

Now insert fixed-angle smartDrive® screws into the second distal row of holes.

The prealignment of these screw holes is such that they run from superopalmar to inferoposterior, with the screw tips precisely at the posterior aspect of the distal radial fragment because this will buttress the latter even more.

Optional: Bone graft transplantation

Harvest any optional bicortical bone chips, e.g., from the iliac crest, with the large iliac crest mill (23-190-06-07).



Core hole drill
AO fitting
Ø 2.0 mm

Depth gauge
single-hand
principle

Depth gauge
AO principle

Screwdriver T8



Core hole drill
AO fitting
Ø 2.0 mm

Depth gauge
single-hand
principle

Depth gauge
AO principle

Screwdriver T8

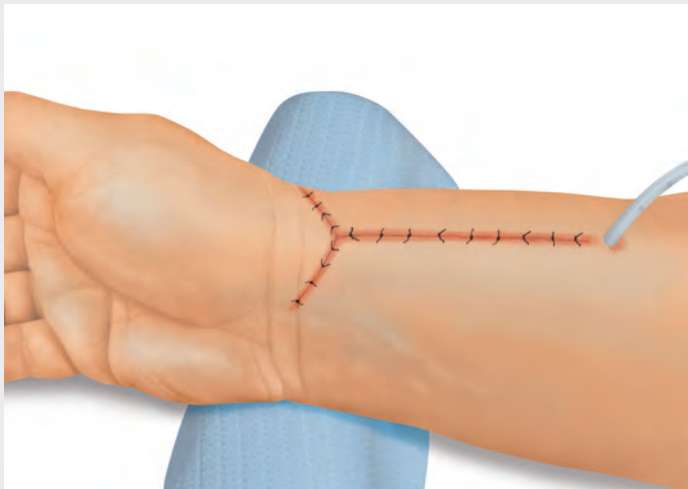

15. Wound closure

If so desired, readapt the pronator quadratus muscle over the plate to minimize any contact with the flexor tendons and muscles. After lavage and check for hemostasis place a stab wound Redon suction drain and close the wound with subcutaneous sutures and atraumatic skin sutures. Cover the closed wound with a sterile dressing and immobilize the lower arm and wrist with a cast also including the ulna.

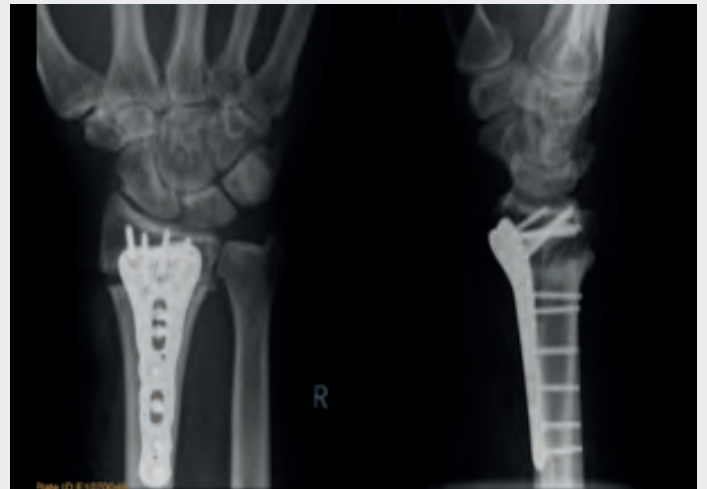

OR documentation

Once the correction has been completed document the result in the OR by fluoroscopy.

Recos® Implants Palmar Ulna Shortening Plates

Recos® ulna shortening 7-hole, short

Length 80 mm
Width 10 mm

Recos® ulna shortening 7-hole, long

Length 90 mm
Width 10 mm



1/1



1/1



Plates

26-166-60-09

 = 1.9/3.2 mm



Templates

26-066-60-09

26-166-70-09

 = 1.9/3.2 mm

26-066-70-09

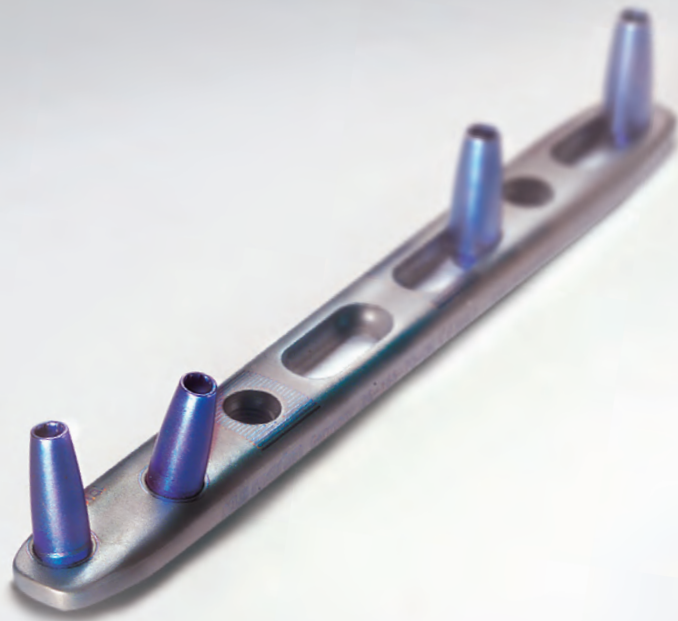

Icon explanations

Screw diameter 2.5 mm

Titanium

Titanium, Dotize®

Packing unit

Multidirectional locking screw hole

Plate profile

STERILE Implants in sterile packaging

Templates for a reliable choice of implants in sterile packaging

**Recos® ulna shortening
7-hole, bridge plate, short**

Length 80 mm
Width 10 mm

**Recos® ulna shortening
7-hole, bridge plate, long**

Length 90 mm
Width 10 mm

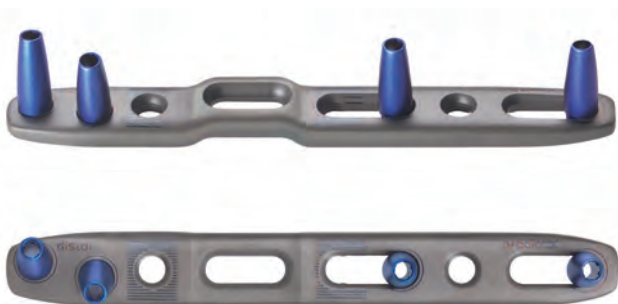

$\frac{1}{1}$

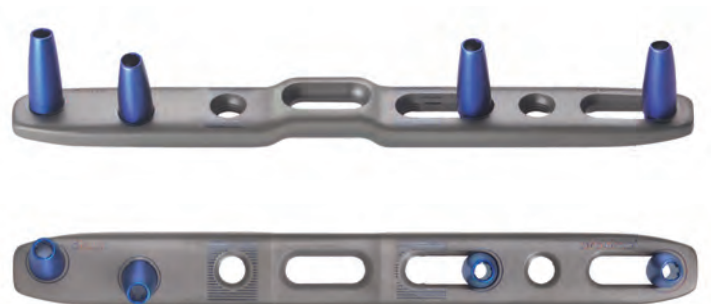

$\frac{1}{1}$



Plates

26-166-65-09

= 1.9/3.2 mm



Templates

26-066-60-09

26-166-75-09

= 1.9/3.2 mm

26-066-70-09

Recos® Implants Palmar Radius Reconstruction Plates

Recos® radius reconstruction 3/2-hole

Length 70 mm

Width 21 mm



Plates

26-166-42-09

= 2.5 mm



Templates

26-066-42-09

26-166-43-09

= 2.5 mm

26-066-43-09

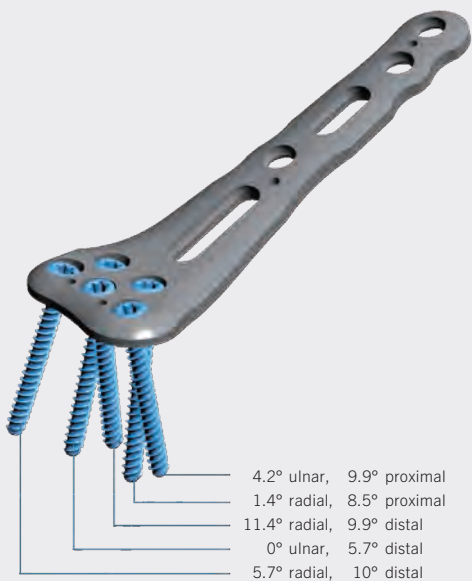

4.2° ulnar, 9.9° proximal
 1.4° radial, 8.5° proximal
 11.4° radial, 9.9° distal
 0° ulnar, 5.7° distal
 5.7° radial, 10° distal

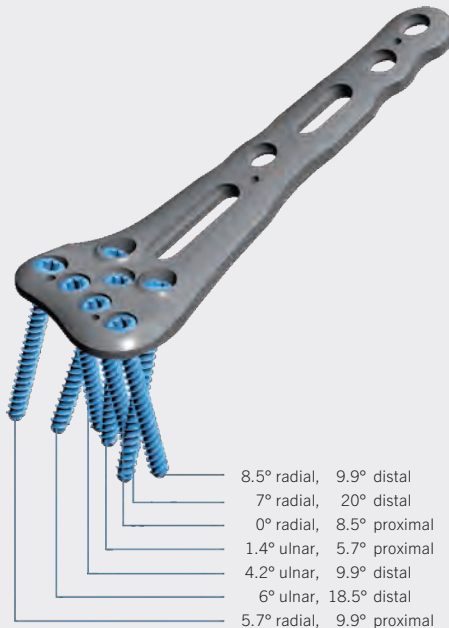

8.5° radial, 9.9° distal
 7° radial, 20° distal
 0° radial, 8.5° proximal
 1.4° ulnar, 5.7° proximal
 4.2° ulnar, 9.9° distal
 6° ulnar, 18.5° distal
 5.7° radial, 9.9° proximal

Icon explanations

- Screw diameter 2.5 mm
- Titanium
- Titanium, Dotize®
- Packing unit
- Multidirectional locking screw hole
- Plate profile

STERILE ↓ Implants in sterile packaging

▭ Templates for a reliable choice of implants in sterile packaging

**Recos® radius reconstruction
 4/3-hole**

Length 70 mm
 Width 24 mm



1/1



1/1



Plates

26-166-40-09

= 2.5 mm



Templates

26-066-40-09

26-166-41-09

= 2.5 mm

26-066-41-09

Recos® Implants Screws

Screws
Multidirectional locking screw
Ø 2.5 mm





1/1

Length	Item No.	STERILE R
8 mm	26-905-08-09	26-905-08-71
9 mm	26-905-09-09	26-905-09-71
10 mm	26-905-10-09	26-905-10-71
11 mm	26-905-11-09	26-905-11-71
12 mm	26-905-12-09	26-905-12-71
13 mm	26-905-13-09	26-905-13-71
14 mm	26-905-14-09	26-905-14-71
15 mm	26-905-15-09	26-905-15-71
16 mm	26-905-16-09	26-905-16-71
17 mm	26-905-17-09	26-905-17-71
18 mm	26-905-18-09	26-905-18-71
19 mm	26-905-19-09	26-905-19-71
20 mm	26-905-20-09	26-905-20-71
22 mm	26-905-22-09	26-905-22-71
24 mm	26-905-24-09	26-905-24-71
26 mm	26-905-26-09	26-905-26-71
28 mm	26-905-28-09	26-905-28-71
30 mm	26-905-30-09	26-905-30-71

Screws
Standard cortical screw
Ø 2.5 mm









1/1

Length	Item No.	STERILE R
8 mm	26-906-08-09	26-906-08-71
9 mm	26-906-09-09	26-906-09-71
10 mm	26-906-10-09	26-906-10-71
11 mm	26-906-11-09	26-906-11-71
12 mm	26-906-12-09	26-906-12-71
13 mm	26-906-13-09	26-906-13-71
14 mm	26-906-14-09	26-906-14-71
15 mm	26-906-15-09	26-906-15-71
16 mm	26-906-16-09	26-906-16-71
17 mm	26-906-17-09	26-906-17-71
18 mm	26-906-18-09	26-906-18-71
19 mm	26-906-19-09	26-906-19-71
20 mm	26-906-20-09	26-906-20-71
22 mm	26-906-22-09	26-906-22-71
24 mm	26-906-24-09	26-906-24-71
26 mm	26-906-26-09	26-906-26-71
28 mm	26-906-28-09	26-906-28-71
30 mm	26-906-30-09	26-906-30-71



Icon explanations

-  Screw diameter 2.5 mm
-  Screw diameter 3.0 mm
-  Titanium
-  T-Drive
-  Packing unit

STERILE  Implants in sterile packaging

Screws

Multidirectional locking screw

Ø 3.0 mm

-  
-  



Length	Item No.
8 mm	26-908-08-09
9 mm	26-908-09-09
10 mm	26-908-10-09
11 mm	26-908-11-09
12 mm	26-908-12-09
13 mm	26-908-13-09
14 mm	26-908-14-09
15 mm	26-908-15-09
16 mm	26-908-16-09
17 mm	26-908-17-09
18 mm	26-908-18-09
19 mm	26-908-19-09
20 mm	26-908-20-09
22 mm	26-908-22-09
24 mm	26-908-24-09
26 mm	26-908-26-09
28 mm	26-908-28-09
30 mm	26-908-30-09

Screws

Standard cortical screw

Ø 3.0 mm

-  
-  



Length	Item No.
8 mm	26-909-08-09
9 mm	26-909-09-09
10 mm	26-909-10-09
11 mm	26-909-11-09
12 mm	26-909-12-09
13 mm	26-909-13-09
14 mm	26-909-14-09
15 mm	26-909-15-09
16 mm	26-909-16-09
17 mm	26-909-17-09
18 mm	26-909-18-09
19 mm	26-909-19-09
20 mm	26-909-20-09
22 mm	26-909-22-09
24 mm	26-909-24-09
26 mm	26-909-26-09
28 mm	26-909-28-09
30 mm	26-909-30-09

Recos® Instruments

Standard instruments



26-166-25-07
Drill guide
classic
13.5 cm / 5 1/4"



26-166-27-07
Drill guide
monoaxial
13.5 cm / 5 1/4"



26-950-20-07
Core hole drill
AO fitting
Ø 2.0 mm
11 cm / 4 1/4"









26-166-21-07
Depth gauge
single-hand principle
15 cm / 5 3/4"





Icon explanations

-  Screw diameter 2.5 mm
-  Screw diameter 3.0 mm
-  Steel
-  Silicone
-  T-Drive
-  Packing unit

Standard instruments



1/2

26-166-18-07
T8 screwdriver
18 cm / 7"



1/2

26-166-13-07
K-wire dispenser
Ø 1.2 mm
17.5 cm / 6 3/4"



1/2

22-627-12-05
K-wires
Ø 1.2 mm
12 cm / 4 3/4"



Recos® Instruments

Special instruments for ulna shortening

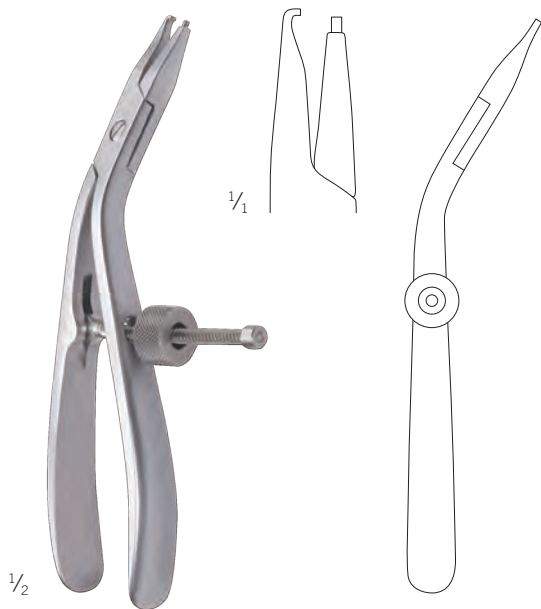

26-166-11-07
Compression forceps
left
15 cm / 6"

St 1 unit(s)

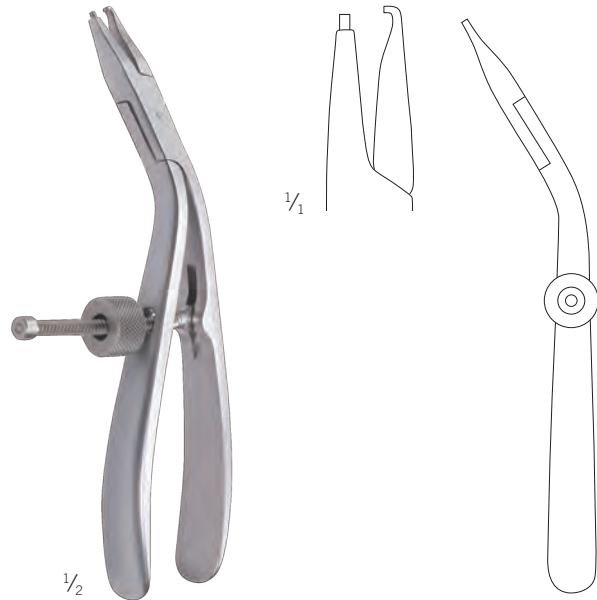





26-166-10-07
Compression forceps
right
15 cm / 6"

St 1 unit(s)



Picture shows left-side ulna / left-side compression forceps

Icon explanations

-  Steel
-  Titanium
-  T-Drive
-  Packing unit
-  Packing unit

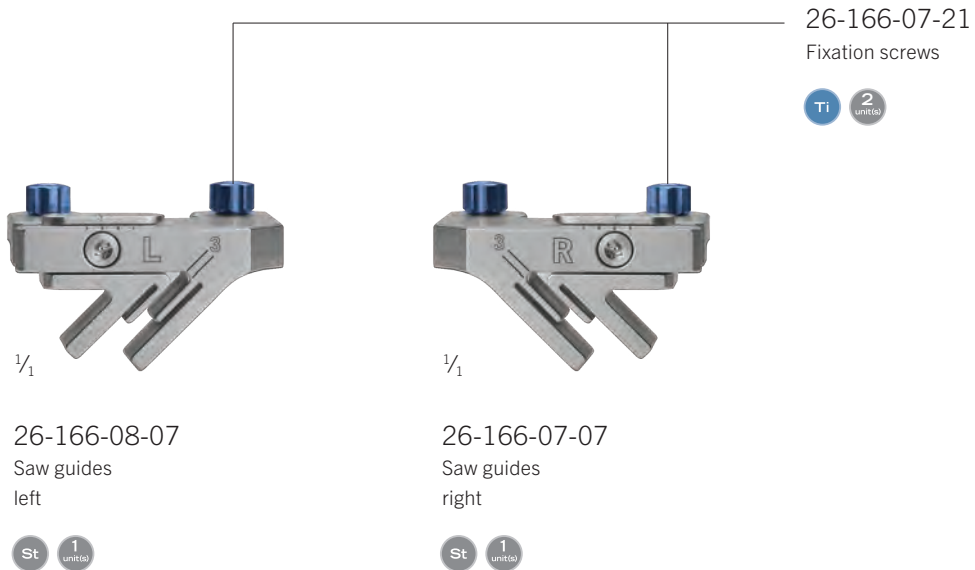

Recos® Instruments

Optional Instruments



1/2

26-166-20-07
Depth gauge
AO principle
15 cm / 5 3/4"



1/2

26-166-30-07
Drill guide
classic
13.5 cm / 5 1/4"



1/2

26-166-32-07
Drill guide
mono
13.5 cm / 5 1/4"



1/1

26-166-33-71
Drill sleeves 3.0

STERILE ↓









1/2

26-166-19-07
T8 screwdriver
rotary
19 cm / 7 1/2"







Icon explanations

-  Screw diameter 2.5 mm
-  Screw diameter 3.0 mm
-  Titanium, Dotize*
-  Steel
-  Silicone
-  T-Drive
-  Packing unit

STERILE  Implants in sterile packaging

Drill bits / sawblades



Screw	Ø	Non-sterile	STERILE 
smartDrive®	2.5 mm 		
Core hole	2.0 mm	26-950-20-07	26-950-21-07
Gliding hole	2.5 mm	26-950-25-07	26-950-26-07
smartDrive®	3.0 mm 		
Core hole	2.5 mm	26-950-30-07	26-950-30-71
Gliding hole	3.0 mm	26-950-31-07	26-950-31-71

Fitting	STERILE 
A0	26-166-15-71
Stryker	26-166-16-71
madriMed	26-166-17-71

Recos[®] Storage System

The Recos[®] storage system consists of various modules.

All instruments that are absolutely imperative for a surgery are stored separately in the instrument tray.

Optional instruments such as the instrument set required for smartDrive[®] screws Ø 3.0 mm can also be stored separately in the storage cage.

The double-sided circular screw rack additionally provides the opportunity to store locking and standard screws with a diameter of 3.0 mm. The circular screw rack can be stocked individually.



Storage system

55-910-10-04 Storage set consisting of:
lid, instrument insert, storage cage, circular screw rack Ø 2.5 mm, single-sided

55-910-11-04 Storage set consisting of:
lid, instrument insert, storage cage, circular screw rack Ø 2.5/3.0 mm, double-sided



55-910-59-04
Lid

1
units(s)



55-910-13-04
Instrument insert
for storage system

1
units(s)



55-910-14-04
Storage cage

1
units(s)



55-910-39-04
smartDrive® Ø 2.5 mm
circular screw rack,
single-sided

1
units(s)



55-910-12-04
smartDrive® Ø 2.5/3.0 mm
circular screw rack,
double-sided

1
units(s)

Template storage

55-910-30-04 Storage set consisting of: storage ring, tag right

55-910-31-04 Storage set consisting of: storage ring, tag left



55-910-30-04
Storage ring,
tag right

1
units(s)



55-910-31-04
Storage ring,
tag left

1
units(s)

KLS Martin Group

KLS Martin Australia Pty Ltd.

Sydney · Australia
Tel. +61 2 9439 5316
australia@klsmartin.com

KLS Martin do Brasil Ltda.

São Paulo · Brazil
Tel. +55 11 3554 2299
brazil@klsmartin.com

KLS Martin Medical (Shanghai) International Trading Co. Ltd.

Shanghai · China
Tel. +86 21 5820 6251
china@klsmartin.com

KLS Martin India Pvt Ltd.

Chennai · India
Tel. +91 44 66 442 300
india@klsmartin.com

Martin Italia S.r.l.

Milan · Italy
Tel. +39 039 605 67 31
italia@klsmartin.com

Nippon Martin K.K.

Tokyo · Japan
Tel. +81 3 3814 1431
nippon@klsmartin.com

KLS Martin SE Asia Sdn. Bhd.

Penang · Malaysia
Tel. +604 505 7838
malaysia@klsmartin.com

KLS Martin de México S.A. de C.V.

Mexico City · Mexico
mexico@klsmartin.com

Martin Nederland/Marned B.V.

Huizen · The Netherlands
Tel. +31 35 523 45 38
nederland@klsmartin.com

Gebrüder Martin GmbH & Co. KG

Moscow · Russia
Tel. +7 499 792-76-19
russia@klsmartin.com

KLS Martin Taiwan Ltd.

Taipei · Taiwan
Tel. +886 2 2325 3169
taiwan@klsmartin.com

Gebrüder Martin GmbH & Co. KG

Dubai · United Arab Emirates
Tel. +971 4 454 16 55
middleeast@klsmartin.com

KLS Martin UK Ltd.

London · United Kingdom
Tel. +44 1189 000 570
uk@klsmartin.com

KLS Martin LP

Jacksonville · Florida, USA
Tel. +1 904 641 77 46
usa@klsmartin.com

Gebrüder Martin GmbH & Co. KG

A company of the KLS Martin Group

KLS Martin Platz 1 · 78532 Tuttlingen · Germany
P.O. Box 60 · 78501 Tuttlingen · Germany
Tel. +49 7461 706-0 · Fax +49 7461 706-193
info@klsmartin.com · www.klsmartin.com

