

ORWAK FLEX 4240

FLEX

COMPACT GENERAL WASTE IN 240 L BINS IN OUR NEW WASTE COMPACTOR FLEX 4240!

It is a robust and reliable machine with a compact and lightweight design. Thanks to the small footprint, it takes up little floor space. The 4240 is easy, safe and convenient to use! The multiple-chamber unit offers a top-loading setup, while the single-chamber version is based on the principle "Roll in! Compact! Roll out!".



Safety



Orwak benefits

MORE PRODUCTIVE USE OF TIME

Less time spent on waste handling, more time for your core activities!

MORE SPACE & ORDER

Our balers rapidly minimizes the space the waste takes up, keeping aisles free and tidy.

LESS COSTS, MORE VALUE

More compaction = less waste volume to transport. Fewer transports required results in lower transportation costs and reduced CO₂ emissions. Sorting at source yields a higher quality of waste material for recycling.



Why Orwak Flex?

- + Versatile compaction for many different application areas
- + Hygienic and safe compaction and disposal of mixed or hazardous waste
- + Special solutions for special needs

ORWAK FLEX 4240

Smart in-bin compaction solution

ORWAK FLEX 4240 IS OPTIMIZED FOR:

SEMI-DRY WASTE

+ General waste

Best suited for dry or semi-dry waste destined for landfill or incineration

ORWAK FLEX 4240 is an in-bin waste compactor for standard two-wheeled 240 L bins.

IDEAL FOR GENERAL WASTE

The 4240 is perfect for the hotel and restaurant sector, where general waste needs to be disposed of in waste bins. The in-bin compactor provides impressive volume reduction, contributing to valuable space-saving and a more profitable waste management.

SAFE AND USER-FRIENDLY

Model 4240 is user-friendly! The multi-chamber version is a convenient top-loading installation, while the single-chamber version has an easy wheel-in, wheel-out operation. Safety and quality are our hallmarks and the compactor provides maximum personal safety both for the operator and those in the immediate vicinity. A bin indicator assures that the machine can only start, when the bin is in the right position.



Designed to fit the standard 240 Liter bins in the market.

SMART DESIGN - EASILY EXTENDABLE

The 4240 is a robust and stable machine that, thanks to its compact design, occupies little floor space. A good finish and easy access make cleaning quick and simple.

The compactor is easily extended with additional chambers. The front door on the single-chamber unit is then replaced by an apron for effortless movement of the press head from one chamber to the next.

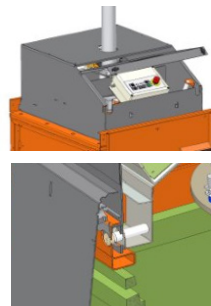

Full protection and no access to moving parts: safety switches on the hatch and the front door/apron



The single-chamber unit with swing door



The multiple-chamber unit equipped with an apron with two handles

DIMENSIONS & SPECIFICATIONS

DIMENSIONS ORWAK FLEX 4240

A	B	C	D	TRANSPORT HEIGHT
Single: 2275 mm	Single: 750 mm	Single: 920 mm	Single: 1515 mm	Single: 2100 mm
Double: 2275 mm	Double: 1475 mm	Double: 990 mm		Double: 2100 mm

MACHINE WEIGHT

TOTAL WEIGHT	PRESS UNIT	SINGLE STAND
Single: 220 kg	Single: 120 kg	Single: 100 kg
Double: 320 kg	Double: 120 kg	Double: 100 kg

TECHNICAL SPECIFICATIONS

BIN SIZE	CYCLE TIME	PRESS FORCE	NOISE LEVEL	PROTECTION CLASS	OPERATING POWER
240 L	29 secs	1.5 ton, 15 kN	62.3 db (A)	IP 55	1 x 230 V, 50 Hz, 10 A or 3 x 200 V, 50/60 Hz, 10 A

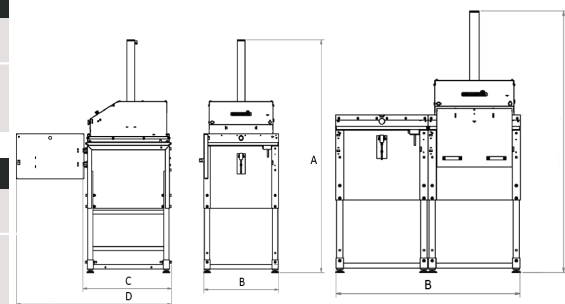

We reserve the right to make changes to specifications without prior notice. Bale/bag/bin weights are dependent upon material type.