



DYNACO
High Performance Doors



DYNACO M3

ALL WEATHER

Push-Pull
gear driven technology



outside door

DYNACO M3 ALL WEATHER

The Dynaco M3 All Weather is specifically designed for large sized outside applications with intensive use and subjected to extreme wind loads. It protects your facilities against wind, rain, snow, dirt and extreme temperatures.

Operating speed and perfect sealing improve your traffic flows and provide employee comfort, environmental control and savings on energy costs. Fully self-reinserting, the Dynaco M3 All Weather will automatically reinsert itself in its side guides when the curtain is accidentally hit.

- **PATENTED “PUSH PULL” TECHNOLOGY:**
Unique door drive system.
- **SUPERIOR SEAL, WIND RESISTANT:**
Patented side frame assembly. Neither blade nor brush systems. Up to wind load class 4.
- **CRASH FORGIVING AND SELF-REINSERTING WITHOUT INTERVENTION:**
The curtain automatically reinserts itself when dislodged. No repair costs, no production down time.
- **USER SAFETY:**
Flexible curtain without rigid elements.
- **COMFORT OF USE:**
DYNACO wireless detector at the bottom.
- **ADVANCED DRIVE:**
Frequency driven motor and encoder for smooth operation. Wearable elements are reduced to a minimum.
- **DYNALOGIC CONTROL BOX:**
User-friendly control box with self-diagnosis.
- **CONFORM TO EN13241-1**

“PUSH-PULL^{PT}” Drive Technology

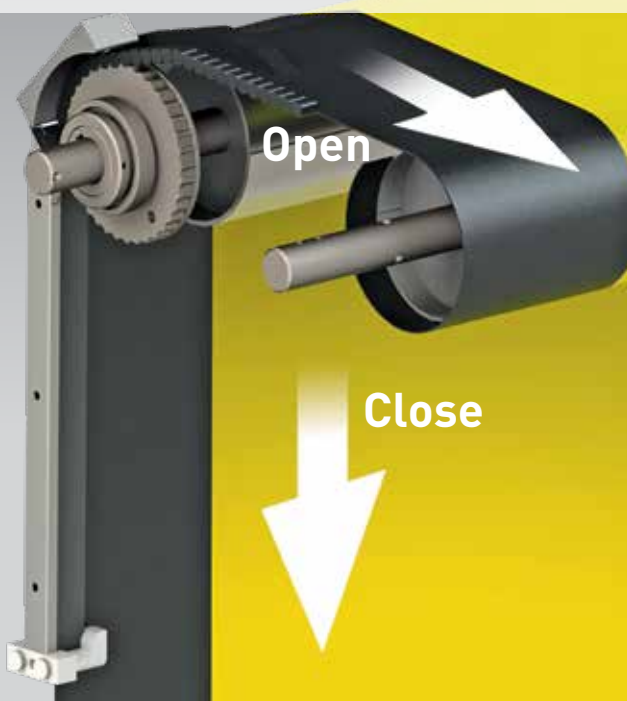

Side reinforcement





























EN13241-1 STANDARDS

Standard	Ref.	Test acc.	Results
Water permeability	EN 12425	EN 12489	Class 1
Wind load	EN 12424	EN 12444	Class 3*
Wind permeability	EN 12426	EN 12427	Class 1**
Safe openings	EN 12453	EN 12445	Pass
Mechanical resistance	EN 12604	EN 12605	Pass
Unintended movements	EN 12604	EN 12605	Pass
Thermal transmittance	EN 12428	EN 12428	6,02 W/m ² K
Performance (cycles)	EN 12604	EN 12605	750.000

* The indicated class for wind resistance applies for maximum dimensions. For doors up to W 6.000mm x H 5.500mm: Class 4

** Valid for a door of 3500 x 3500mm

CHARACTERISTICS

Max. dimensions	W 8.000 mm x H 5.500 mm																
Opening speed Closing speed	Up to 1,4 m/s (W< 7500mm) - 0,8 m/s (W≥7500mm) 0,6 m/s (W<7500mm) - 0,4 m/s (W≥7500mm)																
Structure	Galvanised steel: 100 x 50 x 3 mm.																
Drum	Steel - Ø 140 x 4 mm.																
Side guides	Reinforced polyethylene (PE-UHMW1000), on springs. Side guides reinforced over the total height.																
Motor	4 poles, without brake. Power: 1,5 kW. IP rating: IP65.																
Control box	DYNALOGIC provided with: Circuit breaker, general divider, adjustable timer, push button for opening and reset and emergency stop. IP rating: IP54. Frequency inverter.																
Standard detectors	Infrared barrier: 300 mm from the floor. Wireless DYNACO detector (WDD).																
Power supply Frequency	Single phase 230V - 16 A Frequency: 50-60 Hz																
Available colours comparable with:	<table border="0"> <tr> <td>Yellow RAL1003</td> <td></td> <td>Green RAL6005</td> <td></td> </tr> <tr> <td>Orange RAL2004</td> <td></td> <td>Grey RAL7035</td> <td></td> </tr> <tr> <td>Red RAL3000</td> <td></td> <td>White RAL9010</td> <td></td> </tr> <tr> <td>Blue RAL5002</td> <td></td> <td>Black RAL9005</td> <td></td> </tr> </table>	Yellow RAL1003		Green RAL6005		Orange RAL2004		Grey RAL7035		Red RAL3000		White RAL9010		Blue RAL5002		Black RAL9005	
Yellow RAL1003		Green RAL6005															
Orange RAL2004		Grey RAL7035															
Red RAL3000		White RAL9010															
Blue RAL5002		Black RAL9005															
(Actual colours may deviate. Colour samples available upon request)																	

Side guide and lateral driving strap view

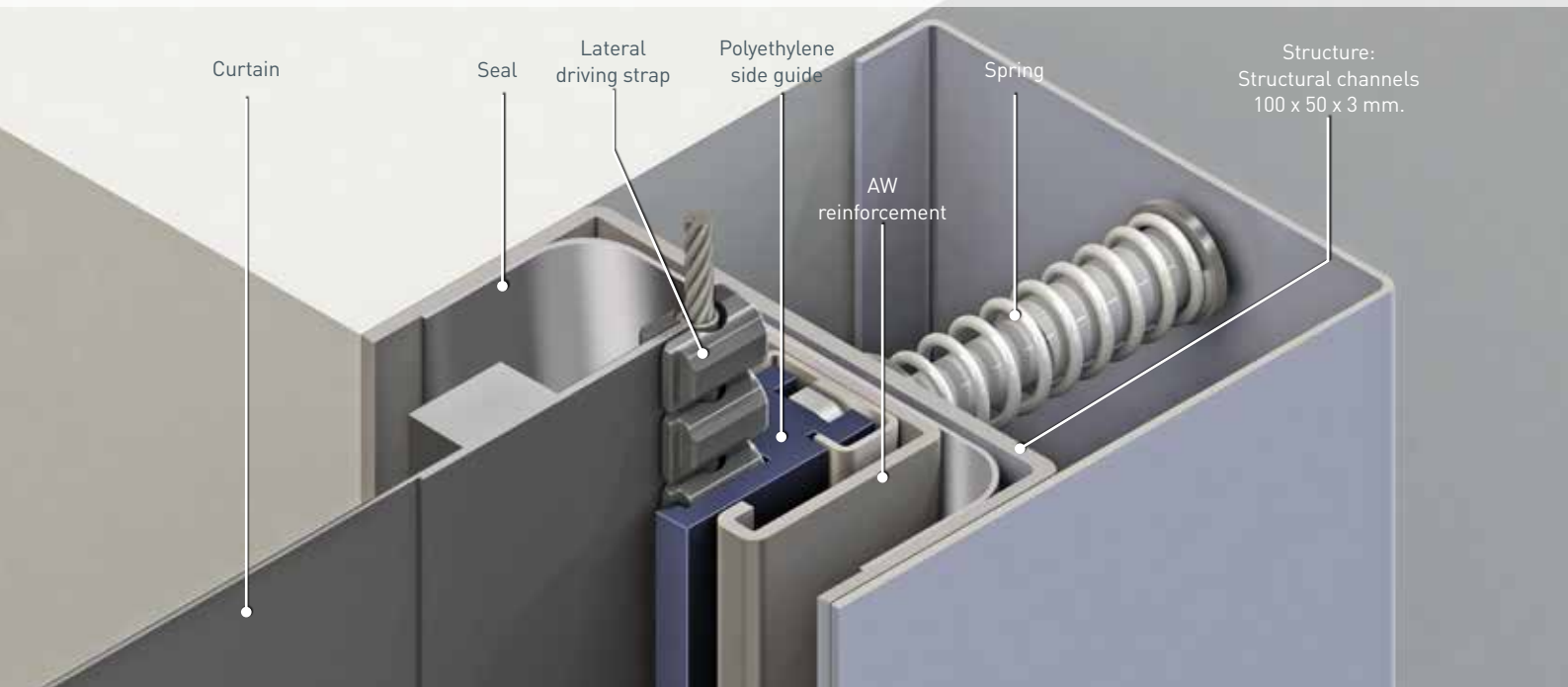

Dimensions and installation requirements Dynaco M3 All Weather

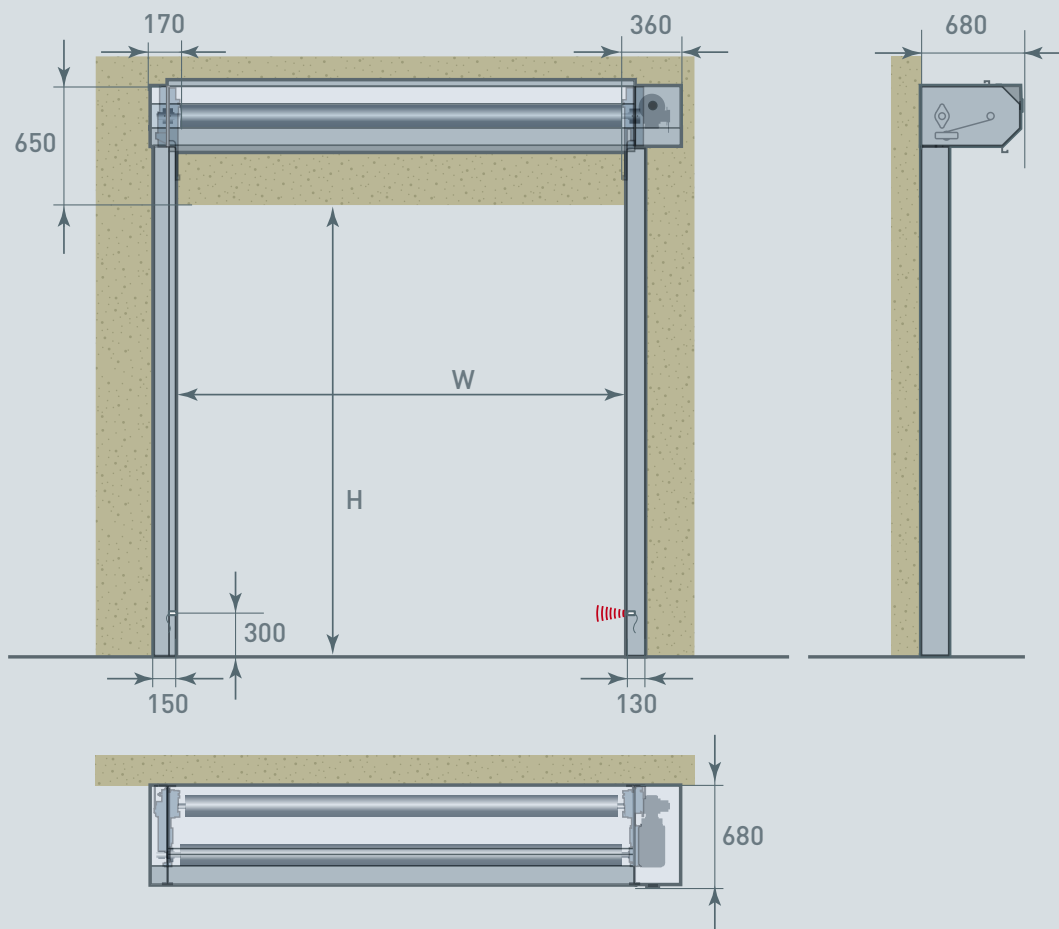

All indicated dimensions are net: the space necessary for mounting and maintenance has to be provided. Remark: drum cover available for doors up to 5900mm wide.

REMARK: Based on the risk analysis of the environment, extra push buttons, detectors and covers might be required.



ENTREMATIc BELGIUM NV
 Waverstraat 21
 B-9310 Moorsel-Aalst (Belgium)
 Tel. +32 53 72 98 98
 Fax. +32 53 72 98 50
 info.dynaco.eu@entrematic.com
 www.dynacodoor.com

About Dynaco

Founded in 1987, the Dynaco brand has a strong heritage and a wealth of expertise in high performance doors. Dynaco is committed to achieving excellence in quality and performance through a certified and dedicated network of partners, providing outstanding service to customers worldwide. Furthermore we trust our USA division and our licensed partners in Russia, Japan, China, Vietnam and Brazil to deliver on our customer promises. Dynaco is part of Entrematic—the home to some of the world's most innovative and leading brands within the entrance automation industry. The comprehensive range of product brands includes Ditec, Normstahl and em/Entrematic.