

01/2023

Mod: LKS/3M

Production code: CR1663520



iPronti

(Bordeaux)

HIGH SPEED OVEN.
ALL IN ONE. COMBI WAVE / HIGH SPEED OVEN.
STANDARD models

TOTAL PLUG & PLAY
DESIGNED FOR USE ANYWHERE

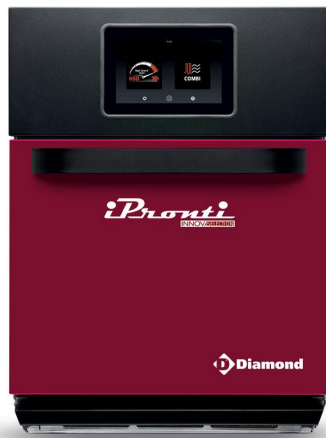

ALL IN ONE



High Speed Oven
Speed in its purest form so you don't keep
your customers waiting.



Combi Wave
Maximum flexibility
in the preparation stages.

AN ALL-AROUND PERFORMER FOR YOUR BUSINESS



High Speed Oven

An operating mode that simultaneously uses convection, microwave and impingement modes, with temperatures from 100°C to 300°C.



Fast Cooking System

Rely on Diamond's know-how by using the automatic, tried-and-tested recipes for high-speed cooking in High Speed Oven mode.



Combi Wave

In Combi Wave mode, iPronti can be used as a convection oven with temperatures from 30°C to 300°C, as a microwave oven with power up to 2000W or with a combination of the two cooking methods to achieve results that always exceed expectations.



Microwave Cooking System

Rely on Diamond's know-how by using the automatic, tried-and-tested recipes for cooking in Combi Wave mode.



Connected

iPronti connects free-of-charge to a portal via the standard- supply Wi-Fi and ethernet features giving you a 4.0 kitchen.



IPX3

General data

Base dimensions (W x D)	mm [inch]	426 x 510 [16.8 x 20.1]	Weight - Net / Gross	kg [lbs]	63 / 75 [139 / 165,4]
External dimensions (W x D x H)	mm [inch]	467 x 609 x 630 [18.4 x 24 x 24.8]	Cooking chamber dimensions (W x D x H)	mm [inch]	310 x 320 x 180 [12.2 x 12.6 x 7]
Maximum external dimensions (W x D x H)	mm [inch]	467 x 657 x 630 [18.4 x 25.9 x 24.8]	Capacity	lt [ft ³]	17,9 [0.64]
Dimensions with packing (W x D x H)	mm [inch]	600 x 800 x 800 [23.6 x 31.5 x 31.5]	Volume	m ³ [ft ³]	0,20 [7.06]



Power supply

Total electric power	kW	3,6	Power supply voltage	V	1N-AC 230 V
Impingement	kW	3	Frequency	H	50 Hz
Microwave	kW	1	Electric connection type		CEE 7 / 7 Schuko 
Consumption	A	16	Cable length	mt [ft]	2 [6.5]

Cooking modes

High Speed Oven		°C [°F]	100 - 300 [212 - 572]
Combi Wave	Convection	°C [°F]	30 - 300 [86 - 572]
	Microwave	W	1000

OPTIONAL ELECTRIC CONFIGURATION, WITHOUT EXTRA CHARGE - TO BE REQUESTED WHEN ORDERING OVEN

Models	Total electric power		Power Output		Power supply voltage	Electric connection type (Plug included)		Cable length (Included)	Option code
			Impingement	Microwave					
	kW	A	kW	kW		mt.			
iPronti	3,6	16	3	1	1N-AC 230 V - 50Hz	IEC 309		2	On request
	3,6	18	3	1	1N-AC 208 V - 60Hz	Not included		2	On request
	3,6	16	3	1	1N-AC 240 V - 60Hz	Not included		2	On request
	3	13	3	1	1N-AC 230 V - 50Hz	BS1363/A		2	On request
	3,3	15	3	1	1N-AC 230 V - 50Hz	A53112		2	On request

COOKING METHODS

- Programmable mode: possibility of programming and storing a recipe with its cooking procedures in automatic sequence.

High Speed Oven

- FCS (Fast Cooking System) automatic cooking system for Italian and international recipes, including the history, ingredients, cooking accessories, method and automatic cooking program.
- Manual mode with instant start.

Combi Wave

- MCS (Microwave Cooking System) automatic cooking system for Italian and international recipes, including the history, ingredients, cooking accessories, procedure and automatic cooking program.
- Manual mode with three instant start cooking methods: convection, microwave or combined convection + microwave.

WI-FI/ETHERNET CONNECTIVITY

- Recipe creation including ingredients with procedure and photo.
- Direct access by iPronti to the recipe database with download option (patented).
- Synchronisation of multiple iPronti ovens connected to the same account (patented).
- HACCP Monitoring.
- Remote diagnosis through a portal by the Service Center.
- Automatic software update notification system.
- Possibility to download recipes from a portal based on country.
- Automatic software updates on multiple devices simultaneously.

OPERATION

- 7" LCD colour screen, high definition, capacitive, with "Touch Screen" functions.
- Display that can be configured based on the needs of the user, bringing forward the programmes used most.
- Automatic cooking with "One Touch" start.
- Organisation of recipes in folders with preview, giving each folder its own name.
- Possibility of preheating the cooking chamber up to 300°C.
- Automatic resumption of cooking in case of a power failure.
- Rapid cooling of the cooking chamber with open door.
- User interface with a choice of 29 languages.
- There are numerous recipes available in iPronti and a growing number of alternative ones are available via access to a portal. Each recipe has been tested to guarantee best results.
- iPronti coach. Virtual assistant that provides advice on using iPronti and informs when maintenance is needed.

CONTROL MECHANISMS

Automatic fan speed for High Speed Oven mode.

Possibility of choosing the fan speed in Combi Wave mode.

USB connection to download HACCP data, update software and upload/download cooking recipes.

CONSTRUCTION

Made of stainless steel.

1-mm-thick AISI 304 stainless steel, diamond-patterned oven with wide radius fully rounded edges for optimal air flow and easy cleaning.

Perfectly smooth oven chamber.

Integrated catalyst filter for operation without hood.

Pull-down door with ergonomic handle.

The door slides under the oven cooking surface, allowing the food to be removed safely without the risk of burns.

Possibility of choosing the external colour.

SAFETY DEVICES

- Door open/closed electronic sensor.
- Self-diagnosis with smart error viewing.
- Max 65°C external temperature on the door panel.
- Compliant with the IEC60335-1, IEC60335-2-90 and EMC international standards.

CLEANING AND MAINTENANCE

- iBox, special removable and washable oven box.
- Easy external cleaning thanks to the perfectly smooth surfaces and IPX3 protection rating against water spray.

INSTALLATION & ENVIRONMENT

- 100% recyclable packaging.
 - Product recycling rate: 90%.
 - Certifications: Quality ISO 9001 / Safety ISO 45001 / Environment ISO 14001.
-

STANDARD EQUIPMENT

- COOKING PLATE
- ALUMINIUM PEEL (190 X 330)
- iBox WASHABLE BOX
- ADESIVE LINING FOR THE INSIDE OF THE DOOR (320 X 192)
- WI-FI CONNECTION
- ETHERNET CONNECTION
- USB CONNECTION
- POWER CABLE (2 MT.)
- PLUG (ONLY FOR 50 HZ)

MULTIPACK - TO BE REQUESTED WHEN ORDERING

- **MPACK:** MULTIPACK PACKAGING - 6 PCS MIXED IN A SINGLE PACKAGE (1200 X 800 X 2170 H - 415 KG - 2,08 M³)

EXTRA ACCESSORIES THAT CAN BE INSTALLED FOLLOWING PURCHASE



- **AK-TL1:** TEFLON TRAY - SMOOTH - 2 PCS. (140 X 286 X 19 H)
- **AK-TL1/2 :** TEFLON TRAY - SMOOTH - 2 PCS. (286 X 286 X 19 H)
- **AK-TP1:** TEFLON TRAY - PERFORATED - 2 PCS. (140 X 286 X 19 H)
- **AK-TP1/2 :** TEFLON TRAY - PERFORATED - 2 PCS. (286 X 286 X 19 H)
- **AK-R1:** GRILL PLATE - RIFLED. NON-STICK HEAT INPUT PLATE - ALUMINIUM ALLOY (286 X 300 X 11 H)
- **AK-PP:** STONE PLATE (280 X 280 X 15 H)
- **AK-PM:** ALUMINIUM PEEL (190 X 330)
- **AK-SSP:** UPPER SHELF REST (467 X 555 X 66 H)
- **AK-PRF:** REAR COVER PANEL (560 X 465 X 100 H)
- **AK-WB:** iPronti WASHABLE BOX. SPECIAL REMOVABLE, NON-STICK, WASHABLE TEFLON OVEN BOX. (305 X 322 X 180 H)
- **AK-SV:** STACKING KIT
- **AK-CL1:** - LIQUID OVEN DETERGENT - CAPACITY 1 L. - PACK OF 6 PCS.

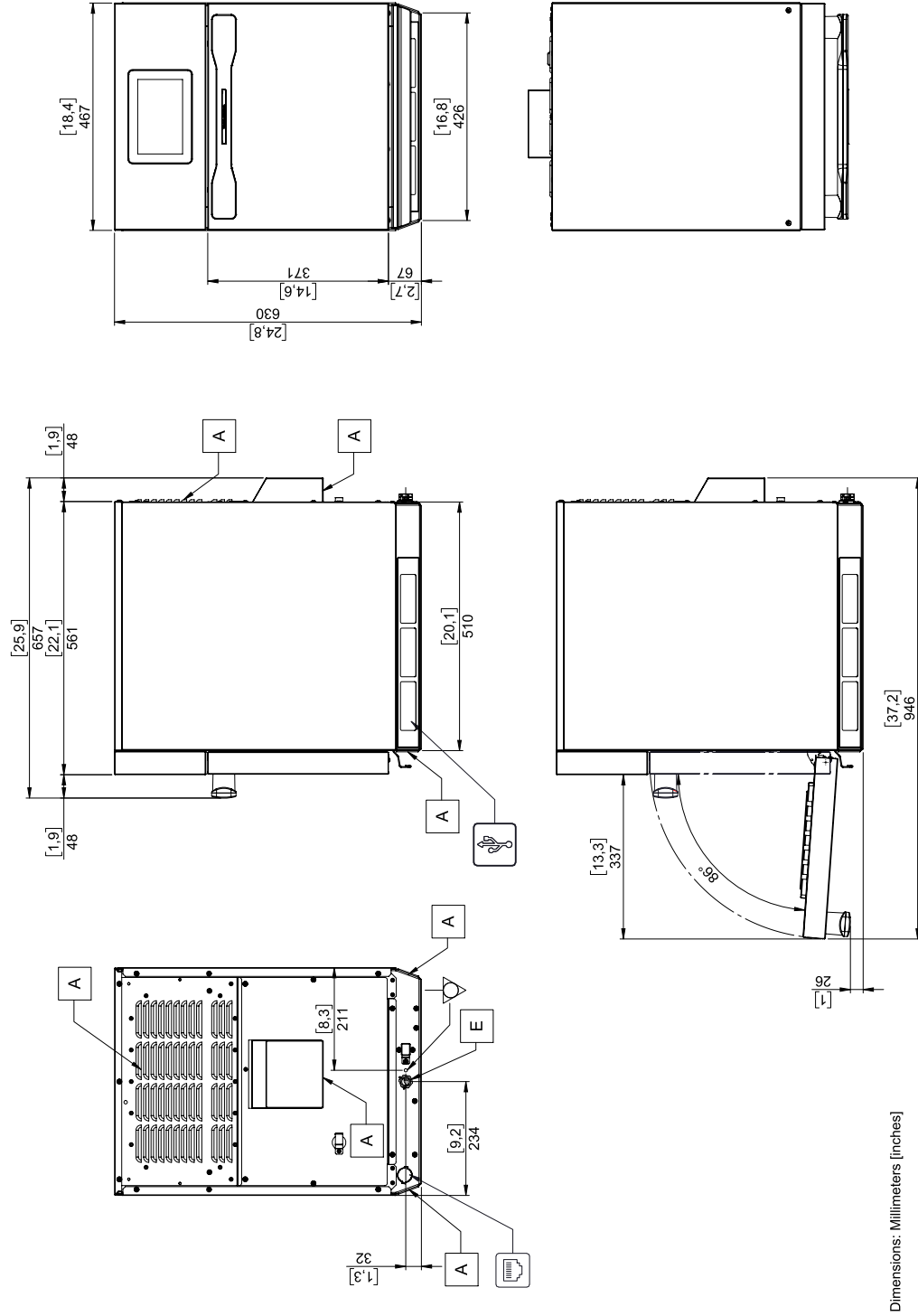

iCompact

iPronti, featuring a base just 51 cm deep and 42,6 cm wide, can be positioned in conventional spaces such as behind counters in bars, bistros, service stations and fast-food chains.



A	Technical compartment cooling air intake
E	Electric power supply cable inlet
	Ethernet connection
	USB connection

The data reported in this document is to be considered non-binding. The company reserves the right to make changes at any time, without prior notice.