

KOBELCO

Performance  Design

SK 85MSR

- Bucket capacity:
0.22–0.28 m³
- Engine power:
53.7 kW/2,100 min⁻¹
- Operating weight:
8,400–8,800 kg





sk85MSR



Performance Design

SK85MSR of KOBELCO has realised a completely new value by harmonising PERFORMANCE – greater efficiency and productivity with an increased power and speed and DESIGN – operator-based operability and comfort, refusing to accept any compromises. In pursuit of unique and matchless machines which are unforgettable once you use them, KOBELCO will continue to rise to meet every challenge.

THE ULTIMATE IN SIMPLE AND ELEGANT DESIGN

Our pursuit of functional beauty and aesthetic sense produced a new interior design.

Jog dial

This jog dial integrates multiple functions to realise simple operations. Even with gloved hands, the operator can set various machine conditions without stress.

LED backlights

The switches and dials have LED backlights – they provide a bright, clear view in the dark and set a luxurious mood.







UNFORGETTABLE COMFORT

① Air suspension seat

A GRAMMER seat is installed as standard equipment, which achieves excellent shock absorption and superior ride comfort.

② Air conditioner blowing from the rear

Air is blown against the operator's waist and the back of their head, offering more comfortable operation.

③ Lever angles allow for comfortable operations

The operator can move the levers horizontally without twisting their wrist, which reduces the fatigue caused by the operations.



④ LED door light

The LED interior light automatically turns on when the door is opened or when the ignition is set to OFF. This ensures easy entry and exit at nighttime.



KOBELCO

ECO

04:33



SETTING MENU



PICTURE OF CAMERA



CLOCK SETTING



SCREEN BRIGHTNESS



MAINTENANCE



CONSUMPTION

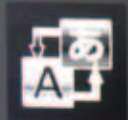

LANGUAGE SELECTION



AVERAGE FUEL CONSUMPTION 4L/h
OPERABLE TIME 12 h

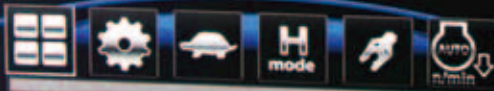

FLOW RATE 128 L/min

A WIDER VIEW BRINGS A WIDER RANGE OF USE

10-inch colour monitor (the largest in the industry)

The easy-to-operate menu screen facilitates reading of important information. Images from the built-in cameras can be checked on the large screen, which helps secure safety. In addition, each icon has become easy to recognise. A password is required when starting the engine for greater security.

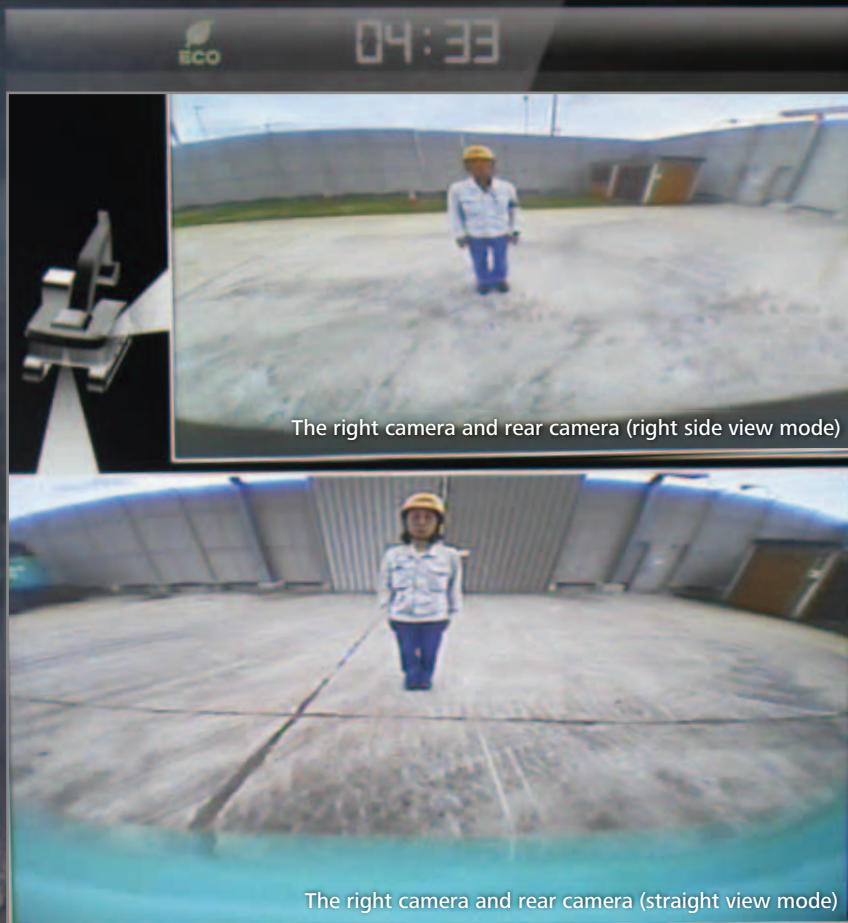

The right camera and rear camera (right side view mode)

The right camera and rear camera (straight view mode)

The right camera and rear camera (right side view mode)

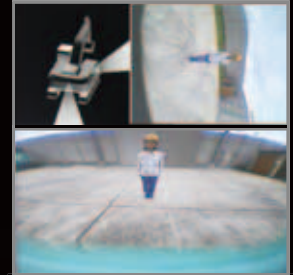

The right camera and rear camera (straight view mode)

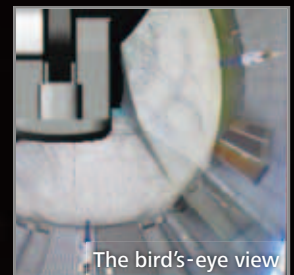

The bird's-eye view



The eagle-eye view (option)

Right and rear cameras

Images from the right camera and rear camera are displayed together on the large colour monitor. The right camera view can be selected between the straight view mode and right side view mode. In addition, the bird's-eye view mode can also be selected. As an optional setting, the eagle-eye view mode can also be selected.

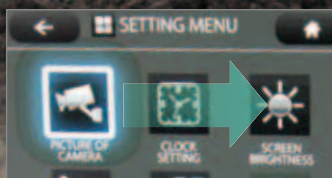

Screen display linked with the jog dial operation

The jog dial can be operated as desired without causing stress. Turn the jog dial to the right or left to select an item and press the dial to confirm the selection.



EXPERIENCING A COMPETENT PERFORMANCE

Our high-power engine complies with STAGE V emission regulations

Compared to previous models, the engine output is significantly increased, which thereby shortens the digging cycle time remarkably. It attains high performances without reducing the speed even when heavy a load is applied or when travelling on a slope.



Model: YANMAR 4TNV98CT

Engine output

Increased by **27.9%**

(Compared to the SK85MSR-3E model)

»» Digging cycle time Shortened by **15%**
(Compared to the SK85MSR-3E model)

Loaded boom lifting speed

Increased by **38%**

(Compared to the SK85MSR-3E model)

Arm digging speed

Increased by **37%**

(Compared to the SK85MSR-3E model)



»» Hill-climbing speed

Increased by **22%**

(Compared to the SK85MSR-3E model)



GREATER MULTI-FUNCTION CAPABILITIES

Attachment mode

The flow-rate modes of the bucket, breaker, nibbler, and rotating grapple are set before delivery, which allows you to start operating immediately. Mode settings for other attachments, such as the tilt rotator, can easily be added or changed.



CONVENIENT AND SENSIBLE EQUIPMENT



Console mount

The console-integrated seat allows for comfortable operation.

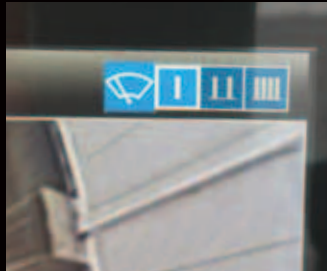

Wiper adjustment function

In addition to the intermittent wiper mode and continuous wiper mode, the one-time wiper mode was added.



USB port/12 V power outlet



Smartphone holder

You can use the holder with your smartphone connected to the USB port.



AM/FM Bluetooth® (hands-free) radio

**Bluetooth® is a registered trademark of the Bluetooth SIG Inc.



Openable TOP guard

The openable guard allows for easy maintenance.



Increased clearance between the upper body and the shoes



Built-in rear camera/right camera



Engine oil drain cock



Remote control fuel drain cock



GEOSCAN

Excavator Remote Monitoring System



Remote Monitoring for Peace of Mind

GEOSCAN uses satellite communication and internet to relay data, and therefore can be deployed in areas where other forms of communication are difficult. When a hydraulic excavator is fitted with this system, data on the machine's operation, such as operating hours, location, fuel consumption, and maintenance status can be obtained remotely.

Direct Access to Operational Status

Location Data

• Accurate location data can be obtained even from sites where communications are difficult.

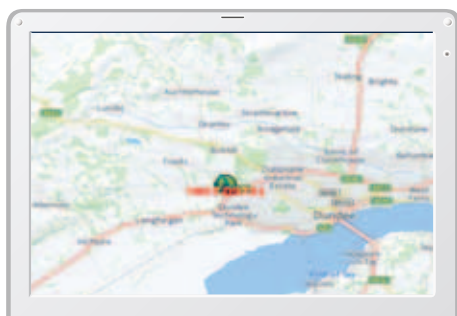

Latest location



Location records

Type of Operation	Working Hrs	Ratio
Total Working Hrs	100 Hrs	100 %
Digging Hrs	72.2 Hrs	43 %
Traveling Hrs	18.3 Hrs	11 %
Idle Hrs	15.9 Hrs	9 %
Opt Alt Hrs	62.5 Hrs	37 %
Crane Mode Hrs	0 Hrs	0 %

Work data

Operating Hours

- A comparison of operating times of machines at multiple locations shows which locations are busier and more profitable.
- Operating hours on site can be accurately recorded, for running time calculations needed for rental machines, etc.

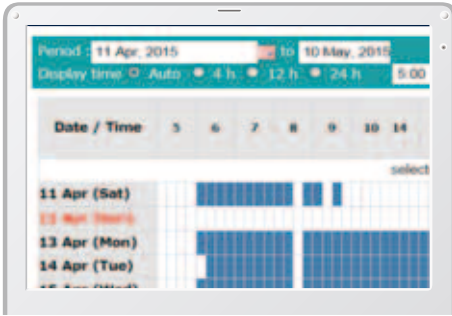

Daily report

Fuel Consumption Data

- Data on fuel consumption and idling times can be used to indicate improvements in fuel consumption.

Work mode	Working Hrs	Total Fuel Consumption
H mode	2:06	24.5 L
S mode	0:00	0.0 L
E mode	169:19	1489.7 L
TOTAL	171:25	1514.2 L

Fuel consumption

Graph of Work Content

- The graph shows how working hours are divided among different operating categories, including digging, idling, travelling and optional operations.

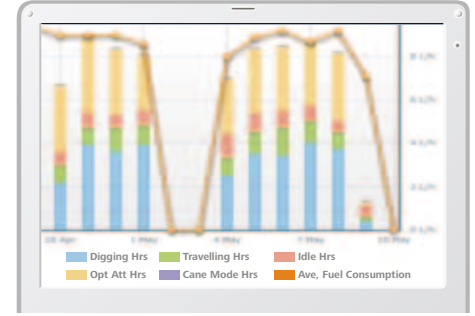

Work status

Maintenance Data and Warning Alerts

Machine Maintenance Data

- Provides maintenance status of separate machines operating at multiple sites.
- Maintenance data is also relayed to KOBELCO service personnel, for more efficient planning of periodic servicing.

Model	Serial No.	Hour Meter	Engine Oil
SK135RLC-3/SK140SRL	YH07-09221	734 Hr	434
SK135RLC-3/SK140SRL	YH07-09789	73 Hr	429
SK210LC-9	YQ13-19454	960 Hr	58
SK210LC-9	YQ13-10481	549 Hr	498
SK755R-	YTO8-30374		

Maintenance

Warning Alerts

- This system warns an alert if an anomaly is sensed, preventing damage that could result in machine downtime.

Alarm Information Can Be Received through E-mail

- Alarm information or maintenance notice can be received through E-mail, using a computer or cell phone.



Alarm messages can be received on mobile device.

Daily/Monthly Reports

- Operational data downloaded onto a computer helps in formulating daily and monthly reports.

Security System

Engine Start Alarm

- The system can be set an alarm if the machine is operated outside designated time.

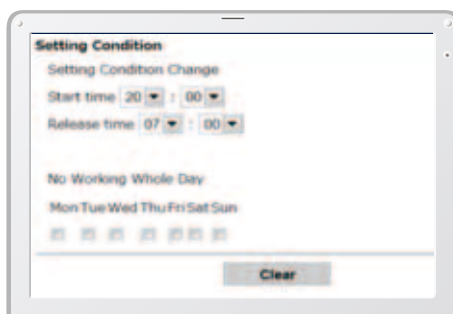

Engine start alarm outside prescribed work time

Area Alarm

- It can be set an alarm if the machine is moved out of its designated area to another location.

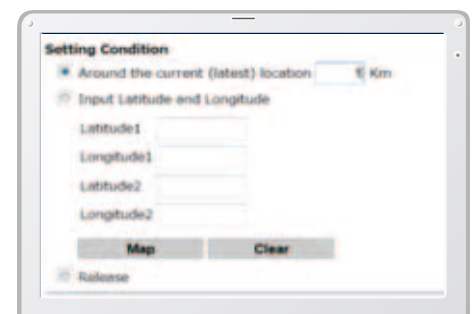

Alarm for outside of reset area

Specifications

Engine

Model	YANMAR 4TNV98CT
Type	Four-stroke, liquid-cooled, direct injection diesel, turbo charged, stage 4 certified
No. of cylinders	4
Bore and stroke	98 mm x 110 mm
Displacement	3.318 L
Rated power output	51.5 kW/2,100 min ⁻¹ (ISO 9249: with fan)
	53.7 kW/2,100 min ⁻¹ (ISO 14396: without fan)
Max. torque	292 N.m/1,365 min ⁻¹ (ISO 9249: with fan)
	296 N.m/1,365 min ⁻¹ (ISO 14396: without fan)

Hydraulic system

Pump	
Type	Variable displacement piston pumps + one gear pump
Max. discharge flow	2 x 72.5 L/min 1 x 19 L/min
Relief valve setting	
Boom, arm and bucket	29.4 Mpa {300 kgf/cm ² }
Travel circuit	29.4 Mpa {300 kgf/cm ² }
Swing circuit	24.5 Mpa {250 kgf/cm ² }
Control circuit	5.0 Mpa {50 kgf/cm ² }
Pilot control pump	Gear type
Main control valves	13-spool
Oil cooler	Air cooled type

Swing system

Swing motor	One fixed displacement piston motor
Brake	Hydraulic; locking automatically when the swing control lever is in the neutral position
Parking brake	Wet multiple plate
Swing speed	11.5 min ⁻¹
Tail swing radius	1,650 mm
Swing torque	17 kN.m

Attachments

Backhoe bucket and combination

Use		Backhoe bucket		
		Standard	Narrow	
Bucket capacity	ISO heaped	m ³	0.28	0.22
	Struck	m ³	0.21	0.18
Opening width	With side cutter	mm	750	650
	Without side cutter	mm	680	580
No. of teeth			4	4
Bucket weight		kg	210	200
Combination	1.87 m arm		⊙	○
	2.13 m arm		△	⊙

⊙ Standard ○ Recommended △ Loading only

Travel system

Travel motors	Variable displacement piston, two-speed motors
Travel brakes	Hydraulic brake
Parking brakes	Wet multiple plate
Travel shoes	39 each side
Travel speed	5.0/2.7 km/h
Drawbar pulling force	77 kN (ISO 7464)
Gradeability	58% {30°}

Cab & control

Cab

All-weather, sound-suppressed steel cab mounted on the silicon-sealed viscous mounts and equipped with a heavy, insulated floor mat

Control

Two hand levers and two foot pedals for travel

Two hand levers for excavating and swing

Electric rotary-type engine throttle

Boom, arm & bucket

Boom cylinders	110 mm x 916 mm
Arm cylinder	95 mm x 839 mm
Bucket cylinder	85 mm x 762 mm

Dozer blade

Dozer cylinder	145 mm x 189 mm
Dimension	2,300 mm {for 450 mm shoe} (width) x 455 mm (height)*
Working range	500 mm (up) x 500 mm (down)

*Dozer width is changed according to the shoe width difference.

Refilling capacities & lubrications

Fuel tank	120 L
Cooling system	12.8 L
Engine oil	11.8 L
Travel reduction gear	2 x 1.3 L
Swing reduction gear	1.5 L
Hydraulic oil tank	44 L tank oil level
	89 L hydraulic system

Working ranges

Unit: m

Range	Arm	3.50 m	
		1.87 m	2.13 m
a- Max. digging reach		7.24	7.50
b- Max. digging reach at ground level		7.07	7.34
c- Max. digging depth		4.18	4.44
d- Max. digging height		7.01	7.23
e- Max. dumping clearance		4.98	5.18
f- Min. dumping clearance		1.95	1.70
g- Max. vertical wall digging depth		3.42	3.75
h- Min. swing radius		2.73	2.80
i- Horizontal digging stroke at ground level		3.11	3.51
j- Digging depth for 2.4 m (8') flat bottom		3.82	4.12
Bucket capacity ISO heaped m ³		0.28	0.22

Digging force (ISO 6015)

Unit: kN

Arm length	1.87 m	2.13 m
Bucket digging force	60.3	
Arm crowding force	37.0	33.6

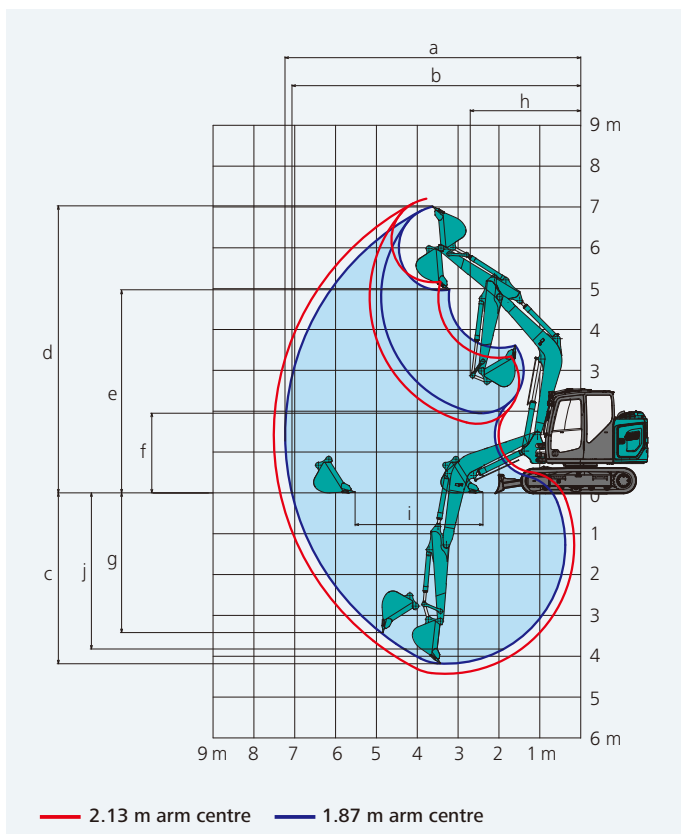

Dimensions

Unit: mm

Boom	3.50 m	
	1.87 m	2.13 m
Arm length	1.87 m	2.13 m
A Overall length	6,730	6,750
B Overall height (to top of boom)	2,400	2,550
C Overall width	2,300**	
D Overall height (to top of cab)	2,570	
E Ground clearance of rear end*	720	
F Ground clearance*	320	
G Tail swing radius (add on counter weight)	1,650 (1,740)	
G' Distance from centre of swing to rear end	1,650	
H Tumbler distance	2,210	
I Overall length of crawler	2,830	
J Track gauge	1,850	
K Shoe width	450	
L Overall width of upperstructure	2,300	
M Dozer blade (up / down)	500/500	

*Without including height of shoe lug **450 mm shoe

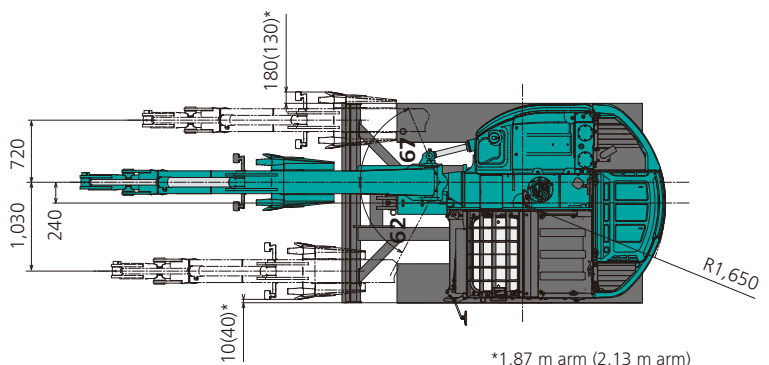
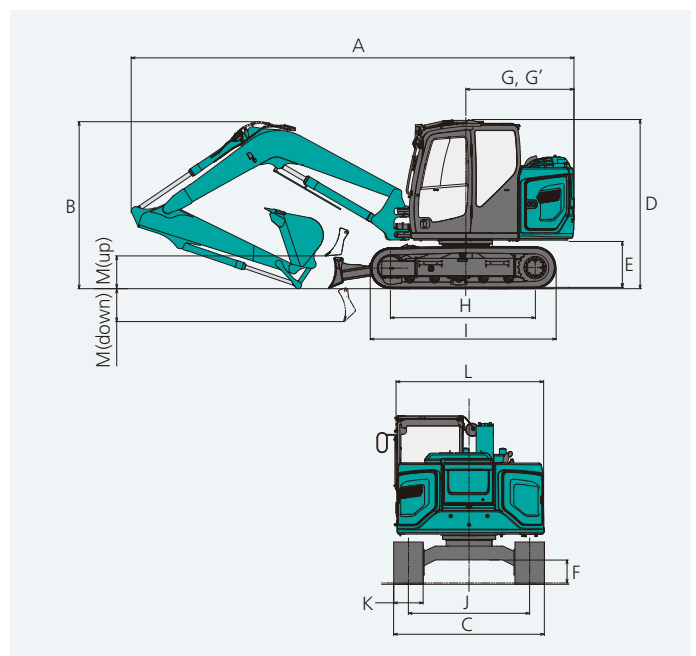

Operating weight & ground pressure

In standard trim, with standard boom, 1.87 m arm, and 0.28 m³ ISO heaped bucket

Shaped		Triple grouser shoes (even height)		Rubber shoes
Shoe width	mm	600		450
Overall width of crawler	mm	2,450		2,300
Ground pressure	kPa	30	38	38
Operating weight	kg	8,800	8,550	8,400

Lift capacities

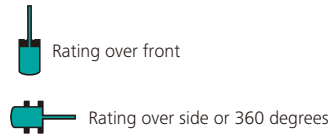
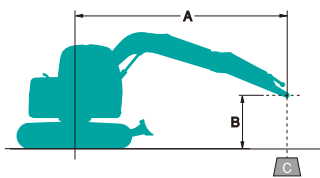





















A: Reach from swing centreline to arm top
 B: Arm top height above/below ground
 C: Lift capacities in Kilograms
 Bucket: Without bucket
 Relief valve setting: 29.4 MPa (300 kgf/cm²)











SK85MSR		Arm: 1.87 m Bucket: Without counterweight: 700 kg Shoe: 450 mm Dozer: Blade up										
A \ B		1.5 m		3.0 m		4.5 m		6.0 m		At max. reach		
												Radius
6.0 m	kg									*1,830	*1,830	3.44 m
4.5 m	kg					1,900	1,640			*1,420	1,280	5.19 m
3.0 m	kg			*3,280	2,980	1,830	1,570			1,150	1,000	5.95 m
1.5 m	kg					1,700	1,450	1,100	950	1,050	910	6.19 m
G.L.	kg			2,970	2,430	1,610	1,370			1,080	930	5.99 m
-1.5 m	kg	*3,950	*3,950	2,990	2,450	1,600	1,350			1,290	1,100	5.27 m
-3.0 m	kg			*2,300	*2,300					*1,760	*1,760	3.64 m

SK85MSR		Arm: 1.87 m Bucket: Without counterweight: 1,050 kg + 300 kg Shoe: 450 mm Dozer: Blade up										
A \ B		1.5 m		3.0 m		4.5 m		6.0 m		At max. reach		
												Radius
6.0 m	kg									*1,830	*1,830	3.44 m
4.5 m	kg					*2,040	1,950			*1,420	*1,420	5.19 m
3.0 m	kg			*3,280	*3,280	2,170	1,880			*1,380	1,210	5.95 m
1.5 m	kg					2,040	1,750	1,340	1,170	1,280	1,110	6.19 m
G.L.	kg			3,590	2,960	1,950	1,670			1,320	1,140	5.99 m
-1.5 m	kg	*3,950	*3,950	3,620	2,980	1,940	1,660			1,570	1,350	5.27 m
-3.0 m	kg			*2,300	*2,300					*1,760	*1,760	3.64 m

SK85MSR		Arm: 2.13 m Bucket: Without counterweight: 700 kg Shoe: 450 mm Dozer: Blade up										
A \ B		1.5 m		3.0 m		4.5 m		6.0 m		At max. reach		
												Radius
6.0 m	kg									*1,460	*1,460	3.97 m
4.5 m	kg					*1,860	1,660			*1,170	1,160	5.51 m
3.0 m	kg					1,840	1,580	1,140	990	1,070	920	6.23 m
1.5 m	kg					1,700	1,450	1,100	940	970	840	6.46 m
G.L.	kg			2,950	2,400	1,590	1,350	1,060	910	990	850	6.26 m
-1.5 m	kg	*3,420	*3,420	2,950	2,410	1,570	1,330			1,160	1,000	5.58 m
-3.0 m	kg			*2,870	2,510					*1,810	1,570	4.13 m

SK85MSR		Arm: 2.13 m Bucket: Without counterweight: 1,050 kg Shoe: 450 mm Dozer: Blade up										
A	B	1.5 m		3.0 m		4.5 m		6.0 m		At max. reach		Radius
												
6.0 m	kg									*1,460	*1,460	3.97 m
4.5 m	kg					*1,860	1,810			*1,170	*1,170	5.51 m
3.0 m	kg					2,010	1,730	1,260	1,100	*1,130	1,020	6.23 m
1.5 m	kg					1,870	1,600	1,220	1,050	1,090	940	6.46 m
G.L.	kg			3,260	2,670	1,770	1,510	1,180	1,010	1,110	960	6.26 m
-1.5 m	kg	*3,420	*3,420	3,270	2,680	1,740	1,480			1,300	1,110	5.58 m
-3.0 m	kg			*2,870	2,780					*1,810	1,740	4.13 m

SK85MSR		Arm: 2.13 m Bucket: Without counterweight: 700 kg + 300 kg Shoe: 450 mm Dozer: Blade up										
A	B	1.5 m		3.0 m		4.5 m		6.0 m		At max. reach		Radius
												
6.0 m	kg									*1,460	*1,460	3.97 m
4.5 m	kg					*1,860	1,810			*1,170	*1,170	5.51 m
3.0 m	kg					2,010	1,730	1,260	1,090	*1,130	1,020	6.23 m
1.5 m	kg					1,870	1,600	1,220	1,050	1,080	940	6.46 m
G.L.	kg			3,250	2,670	1,770	1,500	1,180	1,010	1,110	950	6.26 m
-1.5 m	kg	*3,420	*3,420	3,260	2,670	1,740	1,480			1,290	1,110	5.58 m
-3.0 m	kg			*2,870	2,770					*1,810	1,740	4.13 m

SK85MSR		Arm: 2.13 m Bucket: Without counterweight: 1,050 kg + 300 kg Shoe: 450 mm Dozer: Blade up										
A	B	1.5 m		3.0 m		4.5 m		6.0 m		At max. reach		Radius
												
6.0 m	kg									*1,460	*1,460	3.97 m
4.5 m	kg					*1,860	*1,860			*1,170	*1,170	5.51 m
3.0 m	kg					*2,180	1,890	1,380	1,200	*1,130	1,130	6.23 m
1.5 m	kg					2,040	1,760	1,340	1,160	1,190	1,030	6.46 m
G.L.	kg			3,570	2,930	1,940	1,660	1,300	1,120	1,220	1,060	6.26 m
-1.5 m	kg	*3,420	*3,420	3,580	2,940	1,910	1,630			1,430	1,230	5.58 m
-3.0 m	kg			*2,870	*2,870					*1,810	*1,810	4.13 m

Note:

- Do not attempt to lift or hold any load that is greater than these lift capacities at their specified lift point radius and heights. Weight of all accessories must be deducted from the above lift capacities.
- Lift capacities are based on machine standing on level, firm, and uniform ground. User must make allowance for job conditions such as soft or uneven ground, out of level conditions, side loads, sudden stopping of loads, hazardous conditions, experience of personnel, etc.
- Arm top defined as lift point.
- The above lift capacities are in compliance with ISO 10567. They do not exceed 87% of hydraulic lift capacity or 75% of tipping load. Lift capacities marked with an asterisk (*) are limited by hydraulic capacity rather than tipping load.
- Operator should be fully acquainted with the Operator's and Maintenance Instructions before operating this machine. Rules for safe operation of equipment should be adhered to at all times.
- Lift capacities apply to only machine as originally manufactured and normally equipped by KOBELCO CONSTRUCTION MACHINERY CO., LTD.

STANDARD EQUIPMENT

ENGINE

- Engine, YANMAR 4TNV98CT, Diesel engine with turbocharger and intercooler, Tier IV certified
- Auto Idle Stop
- Automatic engine deceleration
- Batteries (2 x 12 V - 64 Ah)
- Starting motor (24 V - 3.5 kW), 50 amp alternator
- Engine oil pan drain cock
- Double element air cleaner

CONTROL

- Working mode selector (H-mode, S-mode and ECO-mode)
- N&B piping (proportional hand controlled)
- Extra piping (proportional hand controlled)

SWING SYSTEM & TRAVEL SYSTEM

- Swing rebound prevention system
- Straight propel system
- Two-speed travel with automatic shift down
- Sealed & lubricated track links
- 450 mm steel shoes
- Grease-type track adjusters
- Automatic swing brake
- Dozer Blade

MIRRORS, LIGHTS & CAMERAS

- Rear view mirror, rear view camera and right side view camera
- Three front working lights (LED)

CAB & CONTROL

- Two control levers, pilot-operated
- Horn, electric
- Integrated left-right slide-type control box
- LED door light (interior)
- Coat hook
- Large cup holder
- Detachable two-piece floor mat
- GRAMMER air suspension seat with heater
- Retractable seatbelt
- Headrest
- Handrails
- Intermittent windshield wiper with double-spray washer
- Skylight
- Openable top guard (ISO 10262: 1998)
- Tinted safety glass
- Pull-type front window and removable lower front window
- Easy-to-read 10-inch LCD SCREEN multi-display monitor
- Automatic air conditioner
- Emergency escape hammer
- Radio (AUX & Bluetooth)
- 12 V converter
- Hands-free telephone
- USB port
- Multi control valve

OPTIONAL EQUIPMENT

- Various optional arms
- Wide range of shoes
- Front-guard protective structure (may interfere with bucket action)
- Additional counterweight (+300 kg)
- Cab top work LED lights (two lights)
- Mechanical suspension seat
- Rain visor (may interfere with bucket action)
- Quick Hitch piping
- Heavier counterweight (+350 kg)
- Eagle eye view
- Additional track guide
- Lower under cover (9 mm)

Note: Standard and optional equipment may vary. Consult your KOBELCO dealer for specifics.

Note: This catalogue may contain attachments and optional equipment that are not available in your area. And it may contain photographs of machines with specifications that differ from those of machines sold in your areas. Please consult your nearest KOBELCO distributor for those items you require. Due to our policy of continuous product improvements all designs and specifications are subject to change without advance notice.

Copyright by **KOBELCO CONSTRUCTION MACHINERY CO., LTD.** No part of this catalogue may be reproduced in any manner without notice.

KOBELCO CONSTRUCTION MACHINERY CO., LTD.

5-15, Kitashinagawa 5-chome, Shinagawa-ku, Tokyo 141-8626 JAPAN
Tel: +81 (0) 3-5789-2146 Fax: +81 (0) 3-5789-2135
<https://www.kobelcocm-global.com/>

Enquiries To: