

JIALIFT®



www.jialift.com.au

CL1025GH-S

Full Electric Walkie Stacker

- 1000kg Capacity; Max Lifting Height - 2500mm
- Walk-behind operate no license required
- Safe, reliable, sustainable and low maintenance

CE

Full Electric Walkie Stacker - straddle leg (1T/2500mm)

JIALIFT electric stacker CL10GH-S series offers an attractive appearance, convenient operation, and features. It offers a number of **advantages**:

- Walk behind operate no licence required
- Straddle leg design ideal for lifting enclosed pallet
- Can be used for both open pallet and for Australia standard closed pallet (CHEP)
- Control panel: Red Stop Bottom, Key Switch and Battery Indicator on the Right . In-built charger in the middle
- The in-built charger is single phase (wall plug) can be easily charged
- The side-driven design effectively reduces the size of the operation channel.
- With a small turning radius, this stacker is suitable for narrow spaces.
- Intelligent control and drive technology, flexible and safe operating
- Adjustable fork width Easy service and maintenance
- The steering wheel seat in the middle.
- Adjustable driving speed switch.
- The turtle speed switch on the handle makes low-speed control more precise.
- Germany imported waterproof micro-switches are applied in the cold, damp, dusty and other harsh environments.
- YONGCI motor drive system is with small size, light weight, low loss and high efficiency.

Standard Equipment:

Also Included in our Offer: Battery and Charger

Warranty: 5 Years refer to the JIALIFT warranty terms and conditions



JIALIFT AUSTRALIA PTY LTD

Call Us: 1300 000 168 Email: sales@jialift.com.au

46-48 Geddes St, Mulgrave VIC 3170 Open at 8:30 am - 5:30 pm, Monday-Friday



www.jialift.com.au

JIALIFT®

MATERIAL HANDLING EQUIPMENT

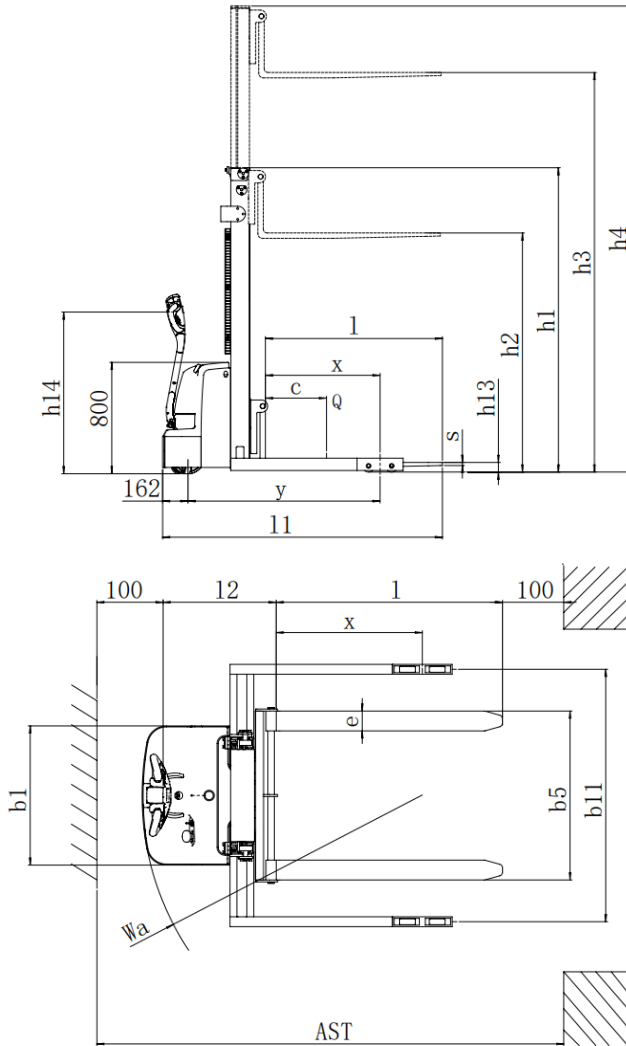

JIALIFT AUSTRALIA PTY LTD

Call Us: 1300 000 168 Email: sales@jialift.com.au

46-48 Geddes St, Mulgrave VIC 3170 Open at 8:30 am - 5:30 pm, Monday-Friday



www.jialift.com.au

Distinguishing mark		
Model designation		CL1025GH-S
Load capacity	kg	1000
Load capacity on max. Height	kg	800
Max lifting height	mm	2500
Load center distance	mm	600
Weight		
Service weight	kg	540
Dimensions		
Fork length	mm	1150
Single fork width	mm	100
Overall fork width	mm	830
Lowered fork height	mm	60
Fixed leg length	mm	1120
Single fixed leg width (including front wheel frame)	mm	100
Inside width of two fixed legs	mm	1230
Outside width of two fixed legs	mm	1330
Turning radius	mm	1336
Aisle width for pallets 1200 × 1200 crossways	mm	2274
Overall length	mm	1850
Overall width	mm	1330
Extended mast height	mm	2924
Lowered mast height	mm	1744
Types, Chassis		
Front wheel size, number	mm	100x28, 4
Rear wheel size, number	mm	210x70, 1
Performance data		
Driving speed, laden/ unladen	km/ h	4/4.2
Lifting speed, laden/ unladen	mm/ s	100/155
Lowering speed, laden/ unladen	mm/ s	150/130
Electric-engine		
Drive motor rating	kW	0.75
Lift motor rating	kW	2.2
The controller		24V/90A
The charger		24V/10A
Battery voltage/nominal capacity		2x12V/100AH
Battery dimensions	mm	260/169/215



JIALIFT AUSTRALIA PTY LTD

Call Us: 1300 000 168 Email: sales@jialift.com.au

46-48 Geddes St, Mulgrave VIC 3170 Open at 8:30 am - 5:30 pm, Monday-Friday

www.jialift.com.au