



Kentaur  
Turnstiles  
Full-height gates

# Secure Kentaur Turnstiles

Versatile  
Durable  
Modular

The robust Kentaur turnstiles and full-height gates are especially suitable for securing the perimeter of buildings and property. Versatile versions enable individual combinations of multiple units to be put together. The end point locking system developed by dormakaba prevents people from being trapped in the gates.

#### **Versatility**

The Kentaur product series offers a modular design. Two, three and four-winged units with straight or U-shaped bars can be combined with each other. The same applies for units with bicycle doors, integrated doors, an emergency exit function<sup>1</sup> or of resistance class WK2. The roofs fit with any of the single, multiple or space-saving double units.

#### **Minimal power consumption**

The quiet low-energy drive consumes very little energy and adapts to the speed of the person entering.

#### **Safe passage**

The end point locking implemented in Kentaur turnstiles prevents people from becoming trapped or jammed. After release the turnstile may be stopped at any time and rotated backwards as long as it has not yet completed half of its rotation. Once the turnstile has completed half of its rotary motion, the unit can only be exited in the released direction.

<sup>1</sup> Individual approval required (responsible building authority)







# Advantages of Kentaur Turnstiles

The right combination of security, user comfort and personal safety.

- Users cannot become stuck thanks to end point locking
- Versions with integrated bicycle door, full-height gates for barrier-free access or as a goods entrance, an emergency exit function or in resistance class WK2
- Space-saving double units
- Modular combination of bars, roofs, guiding and barrier elements
- Lasting quality for indoor and outdoor installation
- Turnstile column and bars made of robust stainless steel
- Rotating speed adapts to the pedestrian
- Low-energy drive
- Low power consumption
- Behaviour in the event of a power failure can be freely determined
- Can be used in regions with harsh environmental conditions
- Integrated, parameterisable random generator
- Optional secondary identification for additional security
- Spacing between shearing edges eliminates risk of injury



Kentaur full-height gates in a matching design offer a fitting solution for disabled access.

# The ideal solution for any access point



Turnstile with integrated full-height gate as entrance to an underground car park



Controlled access to a stadium

Turnstile offering additional protection for a restricted area



Full-height gate as goods entrance



## For reliable security at:

- Manufacturing plants
- Company sites
- Airports and ports
- Power plants
- Car parks
- Bicycle stands
- Correctional facilities
- Military installations
- Educational centres
- Stadiums
- Amusement parks

Throughput rate = up to 20 per minute

Security level = ●●●●○

Comfort = ●●●○○







# Kentaur turnstiles



Standard units	FTS-E01	FTS-L04
<b>Construction</b>		
Column diameter	1130	1130
Portal width	1370	1370
Total height (without opt. roof)	2270	2270
Passage height	2060	2060
Passage width	560	490
Portal and housing	Steel.	Steel.
Lockable maintenance opening	Aluminium.	Aluminium.
Rotating unit with tubular column, Ø 89 mm	180° each with 11 bar-shaped stainless steel AISI 304 crossbars	90° each with 11 bar-shaped stainless steel AISI 304 crossbars
Barrier element	With 11 straight crossbars, made of steel.	With 11 straight crossbars, made of steel.
Passage limitation	With steel columns and climb-over protection.	With steel columns and climb-over protection.
<b>Finish</b>		
Corrosiveness category	Rotating unit made of glossy stainless steel, hot-dip galvanised steel elements, aluminium elements in RAL 9006 (white aluminium). C3 according to DIN EN ISO 12944-2.	Rotating unit made of glossy stainless steel, hot-dip galvanised steel elements, aluminium elements in RAL 9006 (white aluminium). C3 according to DIN EN ISO 12944-2.
<b>Function</b>	Type 2 ****	Type 1.1 ** Type 1.2 *** Type 2 ****
<b>Electrical equipment</b>		
Power supply	The control unit is integrated into the unit. 100 - 240 VAC, 50/60 Hz, 253 VA.	The control unit is integrated into the unit. 100 - 240 VAC, 50/60 Hz, 253 VA.
Standby power consumption	20 VA.	20 VA.
<b>Installation</b>		
Optional roofs	In sleeve foundation, measure X = 150 mm. Suitable for max. snow load of 5.5 kN/m <sup>2</sup> . Suitable for max. wind speed of 108 km/h.	In sleeve foundation, measure X = 150 mm. Suitable for max. snow load of 5.5 kN/m <sup>2</sup> . Suitable for max. wind speed of 108 km/h.
<b>Protection classes</b>	Housing IP33, components conducting supply voltage IP43.	Housing IP33, components conducting supply voltage IP43.

\* Type 0  
Manual motion; mechanically free in one direction/opposite direction blocked

\*\* Type 1.1  
Manual motion; 1 direction electrically controlled/opposite direction blocked (behaviour in event of power failure: both directions blocked or one direction free, one direction blocked)

\*\*\* Type 1.2  
Manual motion; electrically controlled in both directions (behaviour in event of power failure: both directions blocked or both directions free)

\*\*\*\* Type 2  
Power-assisted motion; servo-positioning drive/electrically controlled in both directions (behaviour in event of power failure can be selected for each direction: free or blocked)

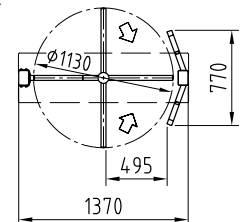
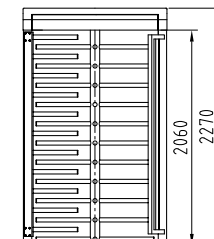
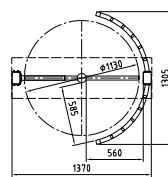
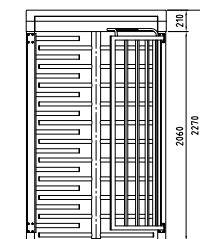

All dimensions in mm





**FTS-E02**

1300

1540

2270

2060

646

Steel.

Aluminium.

120° each with 11 bar-shaped stainless steel  
AISI 304 crossbars

With 11 straight crossbars, made of steel.

With steel columns and climb-over protection.

Rotating unit made of glossy stainless steel,  
hot-dip galvanised steel elements, aluminium  
elements in RAL 9006 (white aluminium).

C3 according to DIN EN ISO 12944-2.

Type 0 \*           Type 1.2 \*\*\*

Type 1.1 \*\*        Type 2 \*\*\*\*

The control unit is integrated into the unit.

100 - 240 VAC, 50/60 Hz, 253 VA.

20 VA.

In sleeve foundation, measure X = 150 mm.

Suitable for max. snow load of 5.5 kN/m<sup>2</sup>.

Suitable for max. wind speed of 108 km/h.

Housing IP33, components conducting supply voltage IP43.

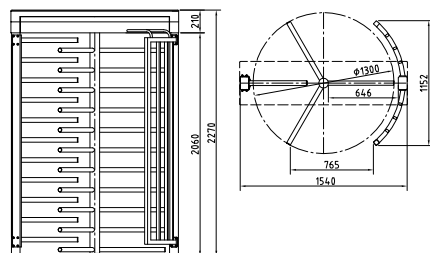

**FTS-E03**

1300

1540

2270

2060

550

Steel.

Aluminium.

90° each with 11 bar-shaped stainless steel  
AISI 304 crossbars

With 11 straight crossbars, made of steel.

With steel columns and climb-over protection.

Rotating unit made of glossy stainless steel,  
hot-dip galvanised steel elements, aluminium  
elements in RAL 9006 (white aluminium).

C3 according to DIN EN ISO 12944-2.

Type 0 \*           Type 1.2 \*\*\*

Type 1.1 \*\*        Type 2 \*\*\*\*

The control unit is integrated into the unit.

100 - 240 VAC, 50/60 Hz, 253 VA.

20 VA.

In sleeve foundation, measure X = 150 mm.

Suitable for max. snow load of 5.5 kN/m<sup>2</sup>.

Suitable for max. wind speed of 108 km/h.

Housing IP33, components conducting supply voltage IP43.

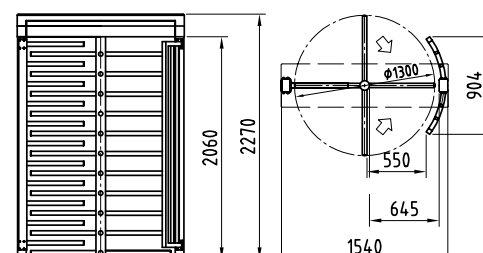

# Kentaur turnstiles



Standard units		FTS-E04
<b>Construction</b>	Column diameter	1300
	Portal width	1540
	Total height (without opt. roof)	2270
	Passage height	2060
	Passage width	646
	Portal and housing	Steel.
	Lockable maintenance opening	AISI 304 stainless steel.
	Rotating unit with tubular column, Ø 89 mm	120° each with 13 bar-shaped stainless steel AISI 304 crossbars
Barrier element	With 12 curved steel bars.	
Passage limitation	With steel columns, climb-over protection and saw-through protection.	
Additional function	The unit complies with resistance class WK2 according to DIN V ENV 1627.	
<b>Finish</b>		Rotating unit made of glossy stainless steel, hot-dip galvanised steel elements, stainless steel maintenance opening in RAL 9006 (white aluminium).
	Corrosiveness category	C3 according to DIN EN ISO 12944-2.
<b>Function</b>		Type 2 ****
<b>Electrical equipment</b>		The control unit is integrated into the unit.
	Power supply	100 - 240 VAC, 50/60 Hz, 253 VA.
	Standby power consumption	20 VA.
<b>Installation</b>		In sleeve foundation, measure X = 150 mm.
	Optional roofs	Suitable for max. snow load of 5.5 kN/m <sup>2</sup> . Suitable for max. wind speed of 108 km/h.
<b>Protection classes</b>		Housing IP33, components conducting supply voltage IP43.

\* Type 0

Manual motion; mechanically free in one direction/opposite direction blocked

\*\* Type 1.1

Manual motion; 1 direction electrically controlled/opposite direction blocked (behaviour in event of power failure: both directions blocked or one direction free, one direction blocked)

\*\*\* Type 1.2

Manual motion; electrically controlled in both directions (behaviour in event of power failure: both directions blocked or both directions free)

\*\*\*\* Type 2

Power-assisted motion; servo-positioning drive/electrically controlled in both directions (behaviour in event of power failure can be selected for each direction: free or blocked)

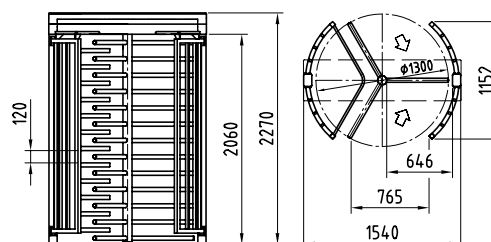

All dimensions in mm





### FTS-E05

1300
1500
2270
2060
646
Steel.
Aluminium.
120° each with 11 bar-shaped hot-dip galvanised steel crossbars.
With 11 straight crossbars, made of steel.
With steel columns and climb-over protection.
-
Rotating unit made of steel, hot-dip galvanised steel elements, aluminium elements in RAL 9006 (white aluminium).
C3 according to DIN EN ISO 12944-2.
Type 1.2 ***
Type 2 ****
The control unit is integrated into the unit.
100 - 240 VAC, 50/60 Hz, 253 VA.
20 VA.
On finished floor level FFL.
-
Housing IP33, components conducting supply voltage IP43.



### FTS-L06

1300
1500
2270
2060
560
Steel.
Aluminium.
90° each with 11 bar-shaped hot-dip galvanised steel crossbars.
With 11 straight crossbars, made of steel.
With steel columns and climb-over protection.
-
Rotating unit made of steel, hot-dip galvanised steel elements, aluminium elements in RAL 9006 (white aluminium).
C3 according to DIN EN ISO 12944-2.
Type 1.2 ***
Type 2 ****
The control unit is integrated into the unit.
100 - 240 VAC, 50/60 Hz, 253 VA.
20 VA.
On finished floor level FFL.
-
Housing IP33, components conducting supply voltage IP43.



### FTS-E06

1300
2340
2270
2060
646
Steel.
Aluminium.
120° each with 11 bar-shaped stainless steel AISI 304 crossbars
In middle part with 21 straight crossbars made of steel.
With steel columns and climb-over protection.
Minimal space requirement due to interlocking rotating units.
Rotating unit made of glossy stainless steel, hot-dip galvanised steel elements, aluminium elements in RAL 9006 (white aluminium).
C3 according to DIN EN ISO 12944-2.
Type 0 *      Type 1.2 ***
Type 1.1 **    Type 2 ****
The control unit is integrated into the unit.
100 - 240 VAC, 50/60 Hz, 506 VA.
40 VA.
In sleeve foundation, measure X = 150 mm.
Suitable for max. snow load of 5.5 kN/m².
Suitable for max. wind speed of 108 km/h.
Housing IP33, components conducting supply voltage IP43.

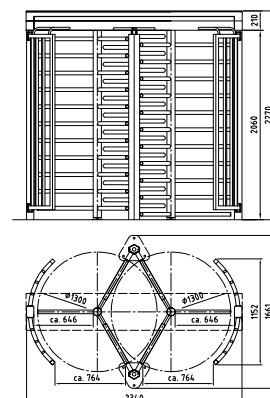
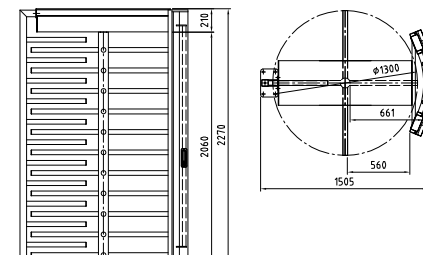
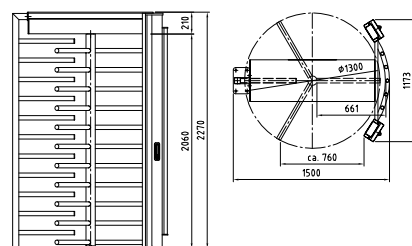

# Kentaur turnstiles



Standard units	FTS-M01	FTS-M02
<b>Construction</b>		
Column diameter	1300	1300
Portal width	2440	2440
Total height (without opt. roof)	2270	2270
Passage height	2060	2060
Passage width	646	646
Portal and housing	Steel.	Steel.
Lockable maintenance opening	Aluminium.	Aluminium.
Rotating unit with tubular column, Ø 89 mm	120° each with 11 bar-shaped stainless steel AISI 304 crossbars	120° each with 7 U-shaped stainless steel AISI 304 crossbars
Barrier element	With 11 straight crossbars, made of steel, with climb-over protection.	With 7 U-shaped crossbars, made of steel, with climb-over protection.
Passage limitation	Half-height made of curved tubular AISI 304 stainless steel with plate panels.	Half-height made of curved tubular AISI 304 stainless steel with plate panels.
Additional function	Automatic bicycle door.	Automatic bicycle door.
<b>Finish</b>		
Corrosiveness category	Rotating unit made of AISI 304 glossy stainless steel, hot-dip galvanised steel elements, aluminium elements in RAL 9006 (white aluminium). C3 according to DIN EN ISO 12944-2.	Rotating unit made of AISI 304 glossy stainless steel, hot-dip galvanised steel elements, aluminium elements in RAL 9006 (white aluminium). C3 according to DIN EN ISO 12944-2.
<b>Function</b>		
Control system	Type 2 **** Automatic bicycle door with two induction loops and loop detector, electronically controlled in two directions.	Type 2 **** Automatic bicycle door with two induction loops and loop detector, electronically controlled in two directions.
Electrical equipment	Control system integrated in the unit.	Control system integrated in the unit.
Power supply	100 - 240 VAC, 50/60 Hz, 506 VA.	100 - 240 VAC, 50/60 Hz, 506 VA.
Standby power consumption	20 VA.	20 VA.
<b>Installation</b>		
Optional roofs	In sleeve foundation, measure X = 150 mm. Suitable for max. snow load of 5.5 kN/m <sup>2</sup> . Suitable for max. wind speed of 108 km/h.	In sleeve foundation, measure X = 150 mm. Suitable for max. snow load of 5.5 kN/m <sup>2</sup> . Suitable for max. wind speed of 108 km/h.
<b>Protection classes</b>	Housing IP33, components conducting supply voltage IP43.	Housing IP33, components conducting supply voltage IP43.

\* Type 0 Manual motion; mechanically free in one direction/opposite direction blocked

\*\* Type 1.1 Manual motion; 1 direction electrically controlled/opposite direction blocked (behaviour in event of power failure: both directions blocked or one direction free, one direction blocked)

\*\*\* Type 1.2 Manual motion; electrically controlled in both directions (behaviour in event of power failure: both directions blocked or both directions free)

\*\*\*\* Type 2 Power-assisted motion; servo-positioning drive/electrically controlled in both directions (behaviour in event of power failure, can be selected for each direction: free or blocked)

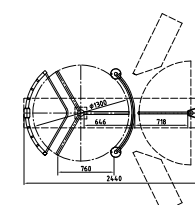
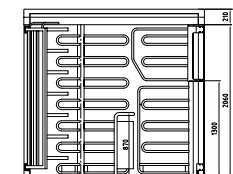
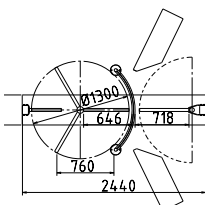
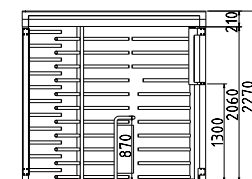

All dimensions in mm





### FTS-M03

1130  
 1940  
 2270  
 2060  
 560  
 Steel.  
 Aluminium.  
 180° each with 11 bar-shaped stainless steel AISI 304 crossbars

Integrated swing door with 10 straight crossbars and continuous frame.

With steel columns and climb-over protection.

Integrated door that can be opened when required.

Rotating unit made of glossy stainless steel, hot-dip galvanised steel elements, aluminium elements in RAL 9006 (white aluminium).

C3 according to DIN EN ISO 12944-2.

Type 0 \*  
 Type 2 \*\*\*\*  
 Type 2: The rotating unit turns automatically 90° in passage direction when the door is opened.

Control system integrated in the unit.

100 - 240 VAC, 50/60 Hz, 253 VA.  
 20 VA.

In sleeve foundation, measure X = 150 mm.

Suitable for max. snow load of 5.5 kN/m<sup>2</sup>.  
 Suitable for max. wind speed of 108 km/h.

Housing IP33, components conducting supply voltage IP43.

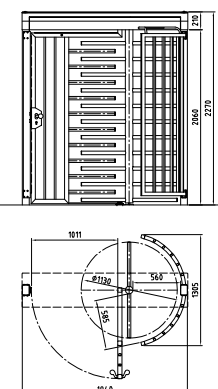

### FTS-M05

1130  
 1940  
 2270  
 2060  
 560  
 Steel.  
 Aluminium.  
 180° each with 11 bar-shaped stainless steel AISI 304 crossbars

Integrated swing door with 10 straight crossbars and continuous frame.

With steel columns and climb-over protection.

The unit has an emergency exit function.

Rotating unit made of glossy stainless steel, hot-dip galvanised steel elements, aluminium elements in RAL 9006 (white aluminium).

C3 according to DIN EN ISO 12944-2.

Type 2 \*\*\*\*  
 Emergency exit function: "individual authorisation" must be granted by the highest authority on building supervision. The rotating unit turns automatically 90° in passage direction when the door is opened.

Control system integrated in the unit.

100 - 240 VAC, 50/60 Hz, 335 VA.  
 20 VA.

In sleeve foundation, measure X = 150 mm.

Suitable for max. snow load of 5.5 kN/m<sup>2</sup>.  
 Suitable for max. wind speed of 108 km/h.

Housing IP33, components conducting supply voltage IP43.  
 IP44 escape route terminal.

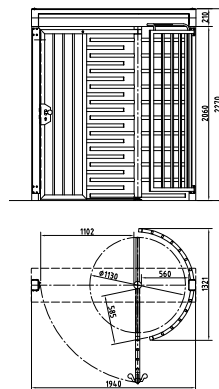

# Kentaur turnstiles



Standard units	FTS-L01	FTS-L05
<b>Construction</b>		
Column diameter	1130	1130
Portal width	2050	1370
Total height (without opt. roof)	2270	2270
Passage height	2060	2060
Passage width	490	490
Portal and housing	Steel.	Steel.
Lockable maintenance opening	Aluminium.	Aluminium.
Rotating unit with tubular column, Ø 89 mm	90° each with 11 bar-shaped stainless steel AISI 304 crossbars.	90° with 11 bar-shaped stainless steel AISI 304 crossbars.
Barrier element	Steel in the mid-section, encased in stainless steel, semi-gloss smooth finish on the front panels.	Steel and encased in stainless steel on the front panels.
Passage limitation	With steel columns.	With steel columns.
Additional function	Low space requirement due to interlocking rotating units.	-
<b>Finish</b>		
Corrosiveness category	Rotating unit made of glossy stainless steel AISI 304, hot-dip galvanised steel elements, aluminium elements in RAL 9006 (white aluminium). C3 according to DIN EN ISO 12944-2.	Rotating unit made of AISI 304 glossy stainless steel, hot-dip galvanised steel elements, aluminium elements in RAL 9006 (white aluminium). C3 according to DIN EN ISO 12944-2.
<b>Function</b>	Type 1.1 ** Type 1.1 *** Type 1.2 **** Type 2 *****	Type 1.1 ** Type 1.1 *** Type 1.2 **** Type 2 *****
<b>Electrical equipment</b>	The control unit is integrated into the unit.	The control unit is integrated into the unit.
Power supply	100 - 240 VAC, 50/60 Hz, 506 VA.	100 - 240 VAC, 50/60 Hz, 253 VA.
Standby power consumption	40 VA.	20 VA.
<b>Installation</b>	On finished floor level FFL.	On finished floor level FFL.
Optional roofs	Suitable for max. snow load of 5.5 kN/m <sup>2</sup> . Suitable for max. wind speed of 108 km/h.	Suitable for max. snow load of 5.5 kN/m <sup>2</sup> . Suitable for max. wind speed of 108 km/h.
<b>Protection classes</b>	Housing IP33, components conducting supply voltage IP43.	Housing IP33, components conducting supply voltage IP43.
<b>Special feature</b>	Ideal for stadiums.	Ideal for stadiums.

\* Type 0 Manual motion; mechanically free in one direction/opposite direction blocked  
 \*\* Type 1.1 With power supply unit and micro switch, bolt control unit provided by the customer, optionally with relay  
 \*\*\* Type 1.1 Manual motion; electrically controlled in 1 direction/opposite direction blocked  
 \*\*\*\* Type 1.2 Manual motion; electrically controlled in 2 directions  
 \*\*\*\*\* Type 2 Power-assisted motion; servo positioning drive/electrically controlled in 2 directions

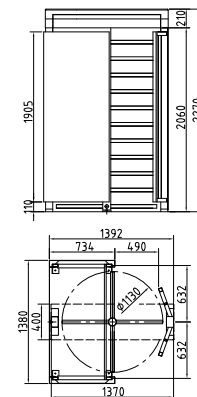
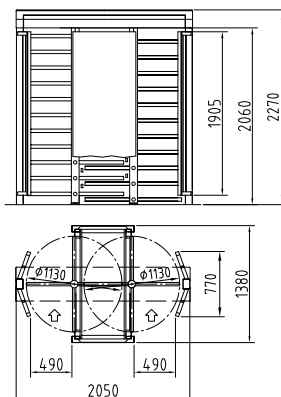

All dimensions in mm



# Kentaur full-height gates



<b>Standard unit</b>	
<b>Application</b>	
<b>Construction</b>	Portal width
	Total height (without opt. roof)
	Passage height
	Passage width
	Portal and housing
	Lockable maintenance opening
	Hinge door with tubular column, Ø 60 mm
<b>Finish</b>	
	Corrosiveness category
<b>Function</b>	
<b>Electrical equipment</b>	
	Power supply
	Standby power consumption
<b>Installation</b>	
	Optional roofs
<b>Protection classes</b>	

<b>FGE-M01</b>	
	Barrier-free passage of persons and material handling.
	1370
	2270
	2060
	1080
	Steel.
	Aluminium.
	With 11 bar-shaped glossy stainless steel AISI 304 crossbars
	Hinge door made of glossy stainless steel.
	Hot-dip galvanised steel elements.
	Aluminium elements in RAL 9006 (white aluminium).
	C3 according to DIN EN ISO 12944-2.
	Type 2*****
	The control unit is integrated into the unit.
	100 - 240 VAC, 50/60 Hz, 253 VA.
	20 VA.
	In sleeve foundation, measure X = 150 mm.
	Suitable for max. snow load of 5,5 kN/m <sup>2</sup> .
	Suitable for max. wind speed of 108 km/h.
	Housing IP33, components conducting supply voltage IP43.

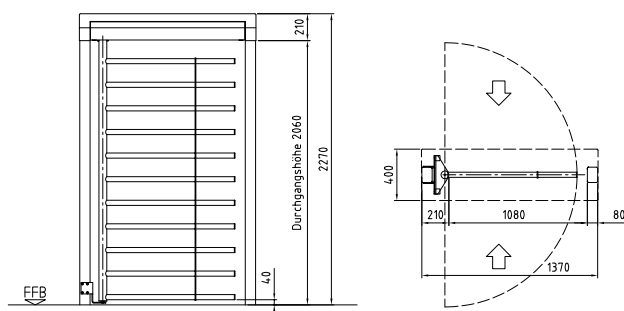

All dimensions in mm

# Optional roofs

	FTS-E01	FTS-L04	FTS-E02	FTS-E03	FTS-E04	FTS-E05	FTS-L06	FTS-E06	FTS-M01	FTS-M02	FTS-M03	FTS-M05	FTS-L01	FTS-L05	FGE-M01
<b>Roof D1</b> – depth 1500 or 2770 (total height 120)															
Width															
1650	•	•												•	•
1820			•	•											
2220											•	•			
2330													•		
2620								•							
2720									•	•					
<b>Roof D2 and roof D3</b> – depth 2820 (roof edge 200)															
Width															
1830	•	•												•	•
2000			•	•											
2400											•	•			
2510													•		
2800								•							
2900									•	•					

## Roofs to prevent people climbing over and for weather protection

### Roof D1

Hot-dip galvanised steel substructure, trapezoidal sheet cover in RAL 9002 grey-white (optional plastic-coated in a RAL colour).

For multiple units we supply one continuous roof. For four units or more a central water outlet is required. The distance between units is 50 mm.

### Roof D2

Hot-dip galvanised steel substructure, trapezoidal sheet cover in RAL 9002 grey-white (optional plastic coating in a RAL colour).

With roof edge in RAL 9006 and water outlet in grey PVC.

For multiple units we supply one continuous roof. The distance between units is 50 mm. The roof edge is continuous with a length of max. 6.4 m.

### Roof D3

Hot-dip galvanised steel substructure, trapezoidal sheet cover in RAL 9002 grey-white (optional plastic coating in a RAL colour).

With roof edge in RAL 9006 and water outlet in grey PVC.

Roof underside with aluminium cladding in lotus white.

For multiple units we supply one continuous roof. The distance between units is 50 mm. The roof edge is continuous with a length of max. 6.4 m.

**All roofs are able to withstand a max. snow load of 5.5 kN/m<sup>2</sup> = snow load zone 3 according to DIN EN 1991-1-3, and max. wind speed of 108 km/h = wind load zone 4 according to DIN EN 1991-1-4.**



**Roof D1** – with trapezoidal sheet cover

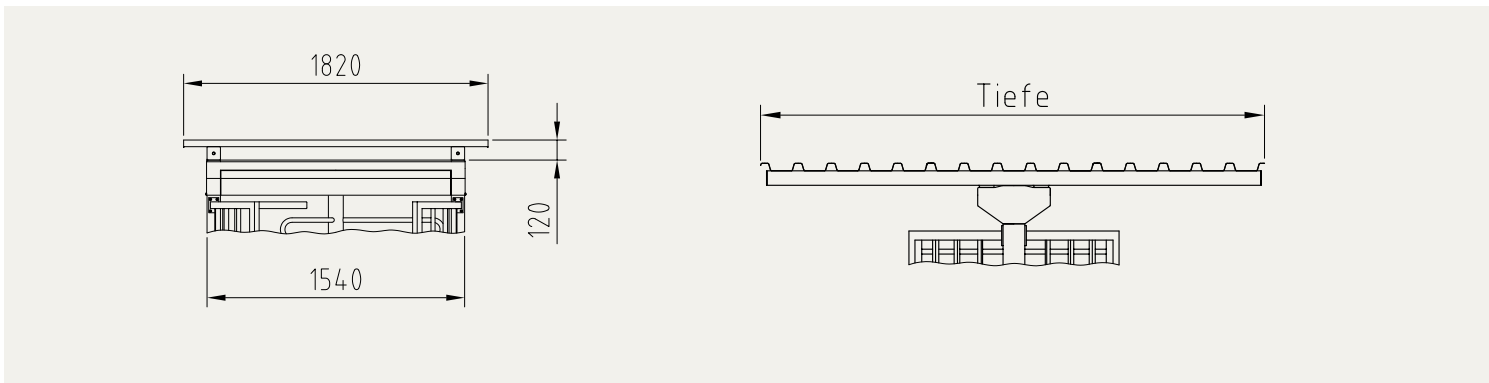

**Roof D2** – with trapezoidal sheet cover, roof edge profile and water outlet

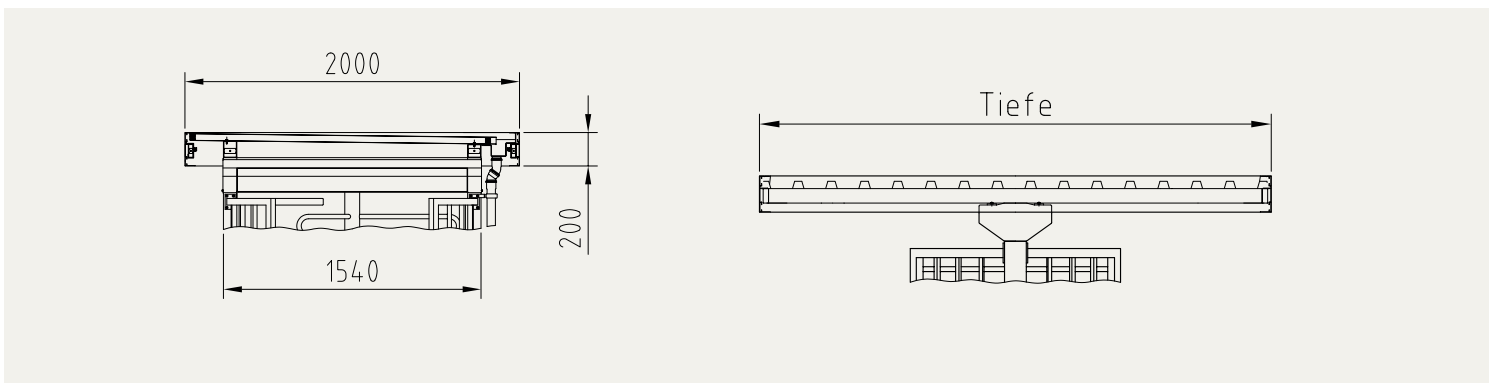

**Roof D3** – with trapezoidal sheet cover, roof edge profile, panelling and water outlet

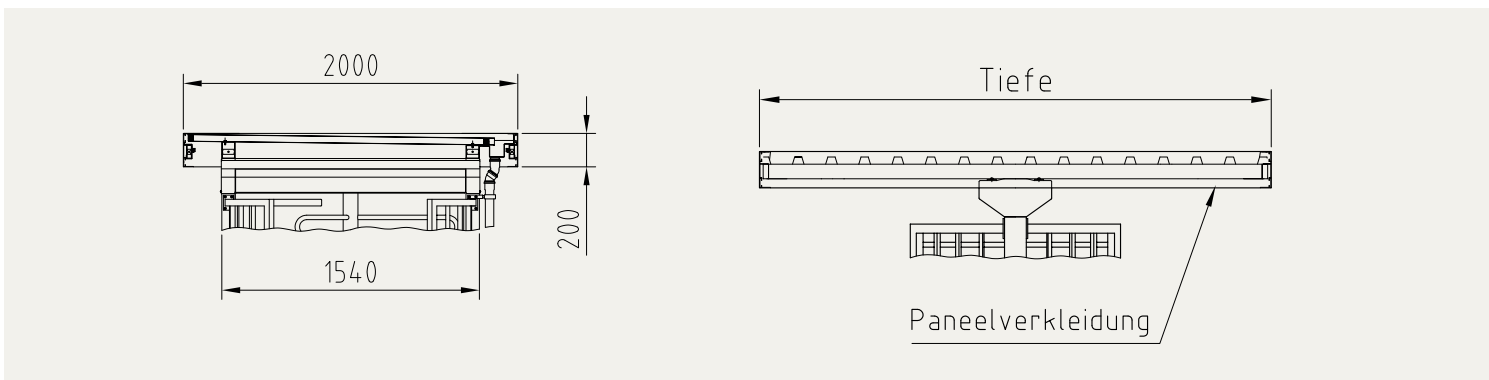

	Depth
	Panelling

All dimensions in mm

# Options (depending on unit type)

	FTS-E01	FTS-L04	FTS-E02	FTS-E03	FTS-E04	FTS-E05	FTS-L06	FTS-E06	FTS-M01	FTS-M02	FTS-M03	FTS-M05	FTS-L01	FTS-L05	FGE-M01
<b>Construction</b>															
Housing with lockable front panel made of light metal, plastic-coated according to RAL or glossy stainless steel.			•					•							
Roofs D1, D2 and D3. Versions depending on unit type: hot-dip galvanised steel substructure and aluminium roof edge 200, as well as trapezoidal sheet, available plastic-coated in RAL colour. The water drainage can be in stainless steel or plastic-coated in a RAL colour instead of grey.	•	•	•	•	•			•	•	•	•	•	•	•	•
Curved barrier element, hot-dip galvanised or plastic-coated according to RAL, instead of straight crossbars.			•	•											
Rotating unit with curved crossbars including curved barrier element.			•												
Rotating unit made of AISI 316 stainless steel	•	•	•	•				•	•	•	•	•	•	•	•
For each direction: mechanical pivoted lever unlocking with profile half cylinder, installed in maintenance opening.	•	•	•	•		•	•	•	•	•	•	•	•	•	•
<b>Finish</b>															
Steel parts and maintenance openings also powder-coated in RAL.	•	•	•	•	•	•	•	•	•	•	•	•	•	•	•
Corrosiveness category C5-M.	•	•	•	•				•					•	•	
<b>Function</b>															
Door opener currentless open/currentless close.											•				
Door opener with slide bar, installed in portal housing or drive, in each case for integrated door.											•	•			
Two concrete blocks with embedded induction loops instead of loops supplied loose.									•	•					
Random generator with or without horn.	•	•	•	•	•	•	•	•	•	•	•	•	•	•	•
<b>Electrical equipment</b>															
Installation preparation for dormakaba detection unit 90 04 and dormakaba compact reader 91 04.	•		•	•	•	•		•					•	•	•
Different consoles made completely of stainless steel or plastic or aluminium in colour of unit or in RAL 9006. Front panels of aluminium consoles available in plastic or stainless steel.	•	•	•	•	•	•	•	•	•	•	•	•	•	•	•
Button for manual single release.	•	•	•	•	•	•	•	•			•	•	•	•	•
Continuous release in the entry/exit direction	•	•	•	•	•	•	•	•	•	•	•	•	•	•	•
Operating panels and frames or surface mount housing.	•	•	•	•	•	•	•	•	•	•	•	•	•	•	•
Additional circuit boards for expanding existing inputs and outputs on unit type 2.	•	•	•	•	•	•	•	•	•	•	•	•	•	•	•
Various signal devices.	•	•	•	•	•	•	•	•	•	•	•	•	•	•	•
Star hub to connect a maximum of four OPL 05s.											•	•			
Various LED lighting and twilight switch options.	•	•	•	•	•			•	•	•	•	•	•	•	•
Heating.	•	•	•	•	•	•	•	•	•	•	•	•	•	•	•
<b>Installation</b>															
Turnstile unit can be assembled at the factory for "finished floor level" and "sub floor level" mounting.	•		•	•		•	•								
Mounting on finished floor level X = 0.	•	•	•	•	•			•	•	•	•	•			•
Mounting on sub floor level X = 150 mm.	•	•	•	•	•			•	•	•	•	•	•	•	•



Console 1 unit made of plastic the same colour as the unit, W/H/D 94/94/65 mm with  $\varnothing$  65 mm opening, e.g. for contactless readers.



Console 2 unit made of aluminium including front plate, the same colour as the unit, W/H/D 140/180/110 mm.

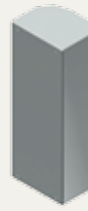

Console 3 unit made of aluminium including front plate, the same colour as the unit, W/H/D 140/365/110 mm.

## Installation variants

### Installation variants using FGE-M01 as an example

Sub floor level

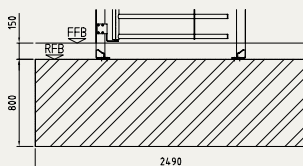

Finished floor level

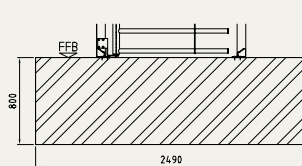

Sleeve foundation

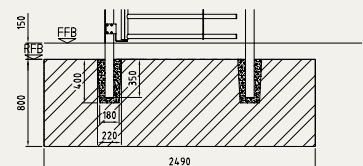

### Installation variants using FTS-E02 as an example

Sub floor level

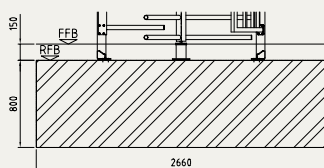

Finished floor level

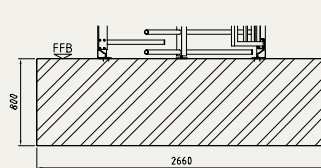

Sleeve foundation

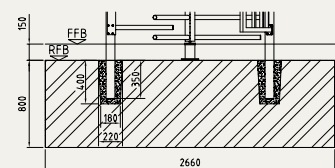

All dimensions in mm





[www.dormakaba.com.au](http://www.dormakaba.com.au)

**Australia**

Head Office  
46-52 Abbott Road  
Hallam VIC 3803  
T: 1800 675 411  
[info.au@dormakaba.com](mailto:info.au@dormakaba.com)  
[www.dormakaba.com.au](http://www.dormakaba.com.au)

**New Zealand**

Head Office  
Building P  
61-69 Patiki Road  
Avondale Auckland 1026  
T: 0800 436 762  
[info.nz@dormakaba.com](mailto:info.nz@dormakaba.com)  
[www.dormakaba.co.nz](http://www.dormakaba.co.nz)