

GINOX 4 ELEC



Spit roast rotisserie oven

Design

Stainless Steel design with powerful lighting system.
Glass-ceramic protected quartz lighting.

Performance

Fast and consistent from 12 to 16 chickens capacity.
The unique individual heating element system provides exceptional control and unmatched durability.
Stainless Steel panels.

Cooking system

4 spits
Adjustable spits allow to cook any type of products from chicken to turkey, lamb, beef and vegetables.
A variety of attachments are also available such as basket spits and chicken spits.
Our rotisserie ingenious spit adjustment guarantees a perfect cooking regardless of the size of the product.
Individual motors.

Cleaning

Easy to clean and safe to maintain
Removable panels
Drain valve

Technical specifications

Connected load: 11kW
415V three-phase N+E – 20A



TOP VIEW

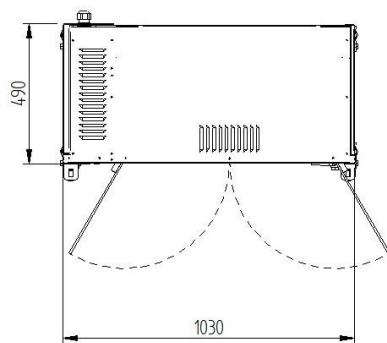

SIDE VIEW

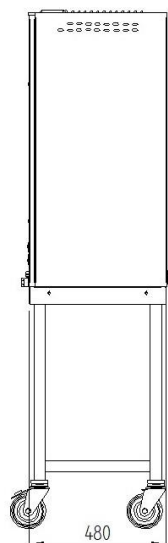

FRONT VIEW

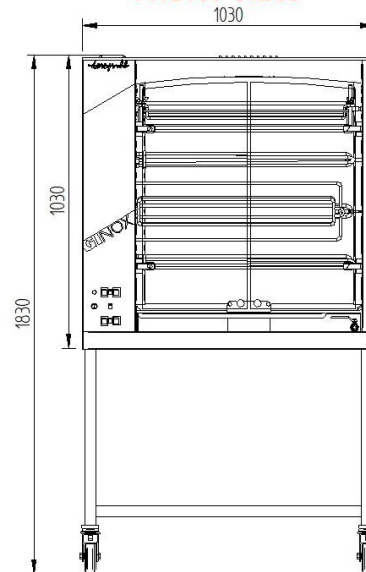

Phoeniks Pty Ltd – Unit 6, 23-25 Clarice Road – Box Hill South – VIC 3128 - Australia
Phone 1300 405 404
contact@phoeniks.com.au
www.phoeniks.com.au